

# Handy Audio Interface U-24

## Operation Manual

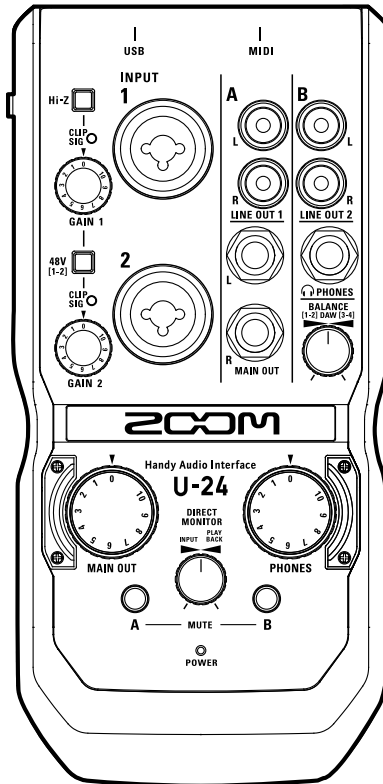

# Contents

Introduction .....	2	Playback .....	14
Safety and Usage Precautions .....	3	Connecting MIDI Devices .....	18
Part Names .....	4	Troubleshooting .....	19
Connecting with a Computer/iOS device .....	6	Specifications .....	20
Recording .....	11	Signal Flow Diagrams .....	21

# Introduction

Thank you for choosing the ZOOM **U-24** Handy Audio Interface. To achieve the best results—and to protect your investment—please read this manual carefully and retain it for future reference. Use this product only as directed.

## 2-in/4-out Audio Interface

The ZOOM **U-24** is a high quality audio interface that supports audio recording and playback at resolutions up to 24-bit/96 kHz.

Featuring an asynchronous transfer system, **U-24** is not impacted by computer jitter, and reproduces audio with complete accuracy.

**U-24** can be used with computers running Windows and Mac OS X, as well as with an iOS device.

## High-Performance Mic Preamps

**U-24** is equipped with high-performance mic preamps that are based on the same design as our H-Series Handy Recorders.

+48V phantom power can be supplied to each input. INPUT 1 also supports Hi-Z input.

## Designed with the DJ in Mind

The **U-24** features 2 RCA outputs that make it easy to connect to DJ mixers or other devices. The balance between computer playback signals 1-2 and 3-4 can be adjusted for the LINE OUT 2 and PHONES outputs.

For example, you can balance the PHONES output between click and MAIN OUT signals during a live performance. Or you can balance between the cue and MAIN OUT signals during a DJ performance.

Plus, the PHONES jack delivers enough volume output for use in clubs and other small venues.

# Safety and Usage Precautions

## Safety Precautions

In this operation manual, symbols are used to highlight warnings and cautions that you must read to prevent accidents. The meanings of these symbols are as follows.



**Warning**

Something that could cause serious injury or death



**Caution**

Something that could cause injury or damage to the equipment

Other symbols used



An action that is mandatory



An action that is prohibited



**Warning**

**Alterations**

- Do not open the case or modify the product.

**Operation using an AC adapter**

- Never use any AC adapter other than a ZOOM AD-17.
- Always hold the AC adapter itself when disconnecting it from an outlet.

**Operation with external DC power supply**

- Use a 5V external DC power supply.
- Carefully study the warning indications of the external DC power supply before use.

**Operation using batteries**

- Use 2 ordinary 1.5-volt AA batteries (alkaline or nickel-metal hydride).
- Read battery warning labels carefully.
- Always close the battery compartment cover when using the unit.



**Caution**

**Product handling**

- Do not drop, bump or apply excessive force to the unit.
- Be careful not to allow foreign objects or liquids to enter the unit.

**Battery handling**

- Install the batteries with the correct +/- orientation.
- Use a specified battery type.
  - Do not mix new and old batteries or different brands or types at the same time.
- When not using the unit for an extended period of time, remove the batteries.
  - If a battery leak should occur, wipe the battery compartment and the battery terminals carefully to remove all residue.

**Operating environment**

- Do not use in extremely high or low temperatures.
- Do not use near heaters, stoves and other heat sources.
- Do not use in very high humidity or where it could be splashed by water.
- Do not use in places with frequent vibrations.
- Do not use in places with much dust or sand.

**Connection cables and input/ output jacks**

- Always turn the power OFF for all equipment before connecting any cables.
- Always disconnect all connection cables and the AC adapter before moving the unit.

**Volume**

- Do not use at a loud volume for a long time.

## Usage Precautions

**Interference with other electrical equipment**

For safety considerations, **U-24** is designed to minimize the emission of electromagnetic waves and suppress interference from external electromagnetic waves. However, interference could still occur if **U-24** is placed next to equipment that is very susceptible to interference of that emits powerful electromagnetic waves. If this occurs, place the **U-24** and the other device farther apart.

With any type of digital control device—including the **U-24**—electromagnetic interference can cause malfunction, corrupt or destroy data, or cause other unexpected issues. Always exercise caution.

**Cleaning**

Use a soft cloth to clean the exterior of the unit if it becomes dirty. If necessary, use a damp cloth that has been wrung out well to wipe it.

Never use abrasive cleansers, wax or solvents such as alcohol, benzene or paint thinner.

**Temperature considerations**

The **U-24** may become warm after long periods of continuous use. This is normal, as long as the unit does not become too hot to touch.

**Breakdown and malfunction**

If the **U-24** malfunctions or operates abnormally, disconnect it immediately. Contact the store where you purchased the unit, or contact ZOOM customer service with the following information: product model, serial number, and the specific symptoms of the breakdown or malfunction—along with your name, address, and telephone number.

**Copyrights**

- Windows<sup>®</sup> is a registered trademark of Microsoft<sup>®</sup> Corporation.
- Mac<sup>®</sup>, iPad<sup>®</sup> and Lightning<sup>™</sup> are trademarks or registered trademarks of Apple Inc.
- MIDI is a registered trademark of Association of Musical Electronics Industry (AMEI).
- iOS is a trademark or registered trademark of Cisco Systems, Inc. (USA).
- Other product names, registered trademarks and company names in this document are the property of their respective companies.

Note: All trademarks and registered trademarks in this document are for identification purposes only and are not intended to infringe on the copyrights of their respective owners.

Recording for any purpose other than personal use from copyrighted sources, including CDs, records, tapes, live performances, video works and broadcasts, without permission of the copyright holder is prohibited by law.

ZOOM Corporation will not assume any responsibility related to infringements of copyrights.

### FCC regulation warning (for U.S.A.)

This equipment has been tested and found to comply with the limits for a Class B digital device, pursuant to Part 15 of the FCC Rules. These limits are designed to provide reasonable protection against harmful interference in a residential installation. This equipment generates, uses, and can radiate radio frequency energy and, if not installed and used in accordance with the instructions, may cause harmful interference to radio communications. However, there is no guarantee that interference will not occur in a particular installation. If this equipment does cause harmful interference to radio or television reception, which can be determined by turning the equipment off and on, the user is encouraged to try to correct the interference by one or more of the following measures:

- Reorient or relocate the receiving antenna.
- Increase the separation between the equipment and receiver.
- Connect the equipment to an outlet on a circuit different from that to which the receiver is connected.
- Consult the dealer or an experienced radio/TV technician for help.

**For EU Countries**



Declaration of Conformity

Part Names

■ Top

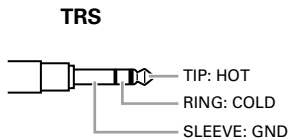
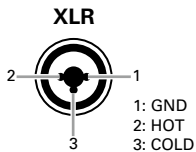
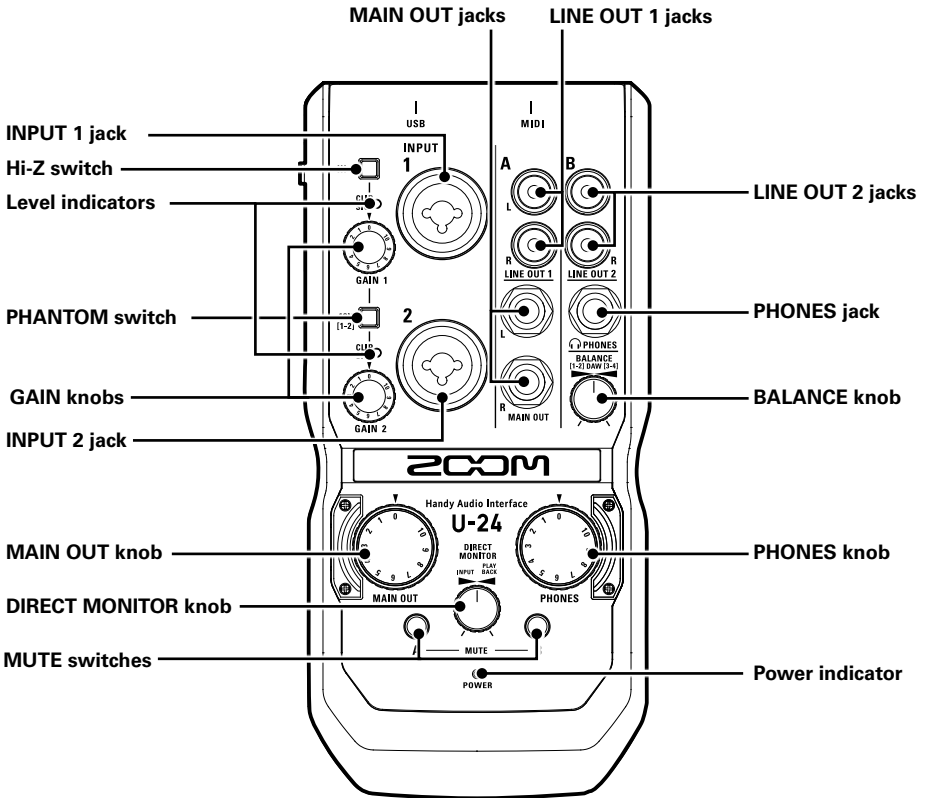

## Part Names (continued)

### ■ Left side

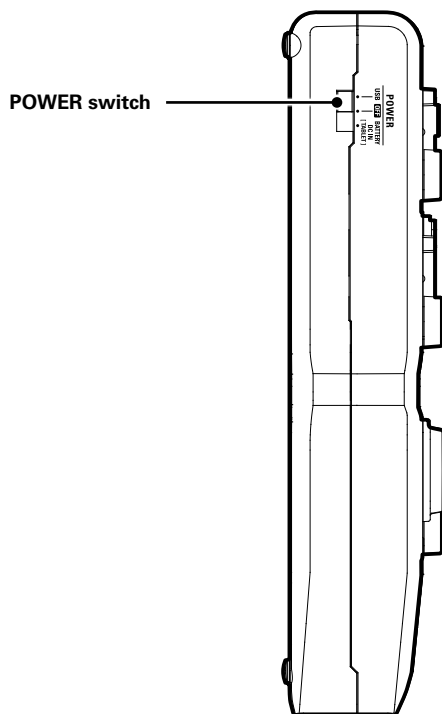

### ■ Back

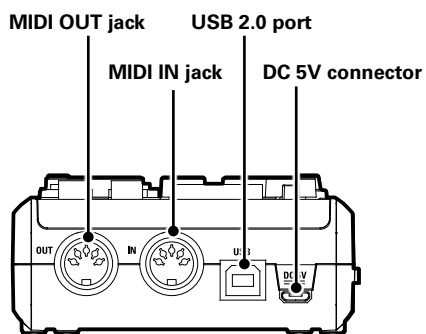

## Installing the Driver

Do not connect the **U-24** until installation completes.

### ■ Windows

- 1.** Download the ZOOM U-24 Driver from <http://www.zoom.co.jp/downloads/> to your computer.

#### NOTE

- You can download the latest ZOOM U-24 driver from the above website.
- Download the driver for the operating system that you are using.

- 2.** Launch the installer and install the driver.

Follow the instructions that appear on screen to install the ZOOM U-24 driver.

#### NOTE

- See the Installation Guide included in the driver package for detailed installation procedures.

### ■ Mac

Driver installation is not necessary when using a Mac.

# Choosing a Power Source

## ■ Using bus power

Use a USB cable to connect the **U-24** to the computer.

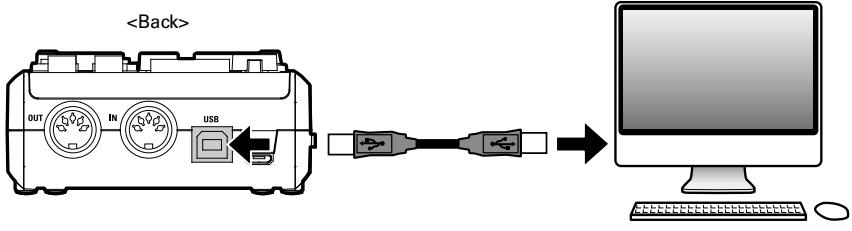

## ■ Using batteries

**1.** Open the battery cover on the **U-24** bottom.

**2.** Install the batteries.

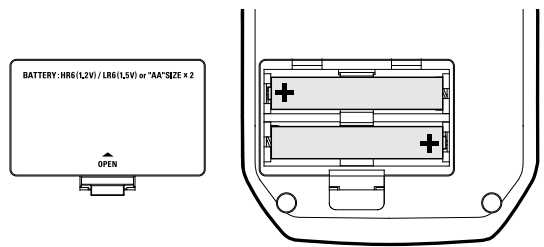

**3.** Replace the battery cover.

**NOTE**

- Use only alkaline batteries or rechargeable NiMH batteries.
- The power indicator will blink when the battery charge becomes low. Turn the power off immediately and install new batteries.

## ■ Using an external power supply

Connect either the optional AD-17 adapter, a commercially available USB power adapter, or a mobile USB battery to the DC 5V connector.

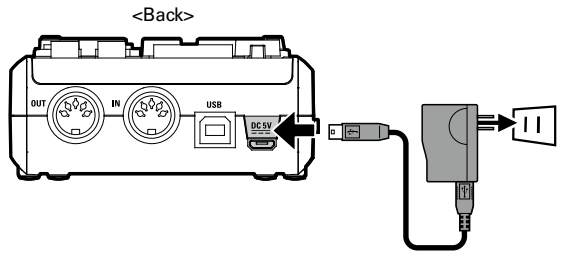

# Connecting with a Computer

1. Minimize the volume of any output devices that are currently connected to the **U-24**.
2. Use a USB cable to connect the **U-24** to the computer.

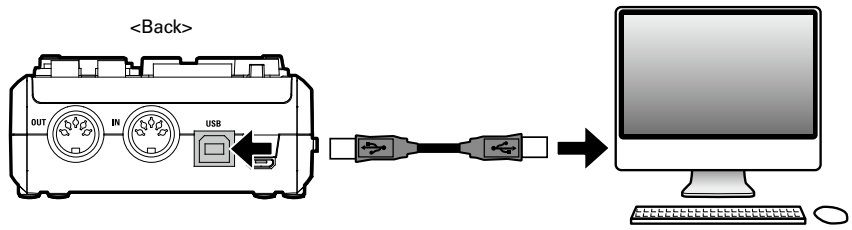

3. Set **POWER** to USB or BATTERY/DC IN to turn the power on.

**NOTE**

- When using batteries or an external power supply, set **POWER** to BATTERY/DC IN.

4. Confirm that the power indicator is lit.

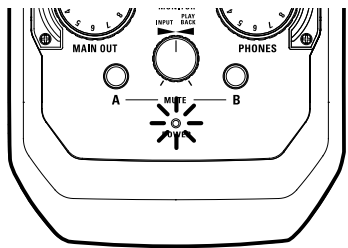



# iOS device Connection

You can connect the **U-24** to an iOS device when using either the optional AD-17 power adapter, an external DC power supply, or AA batteries.

- 1.** Minimize the volume of any output devices that are currently connected to the **U-24**.

---

- 2.** Install batteries or connect an external power supply. (→ P. 7)

---

- 3.** Connect the **U-24** and the iOS device using an Apple iPad Camera Connection Kit or Lightning to USB Camera Adapter.

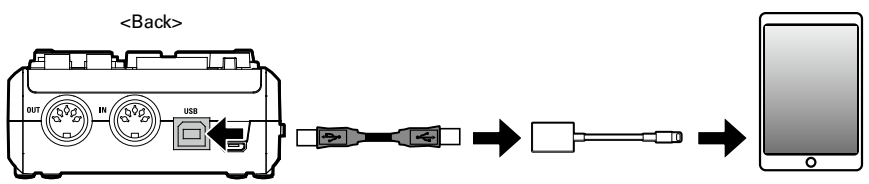

- 4.** Set **POWER** to **BATTERY/DC IN**.  

- After the **U-24** turns on, it will connect to the iOS device.

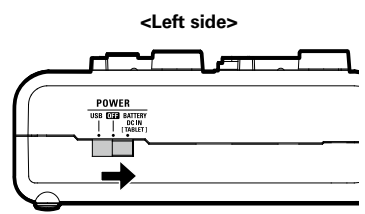

**NOTE**  
 • **U-24** cannot accept bus power from an iOS device.

- 5.** Confirm that the power indicator is lit.

## Turning the Power Off

1. Minimize the volume of any output devices that are currently connected to the **U-24**.
2. Turn off amps, monitor speakers, and any other output equipment that is currently connected to the **U-24**.

3. Set  to OFF.

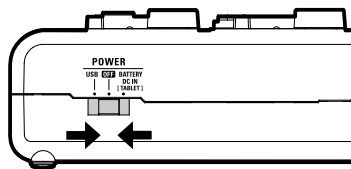

## Connecting Instruments

Instruments can be connected to INPUTS 1/2 using TRS or mono instrument cables.

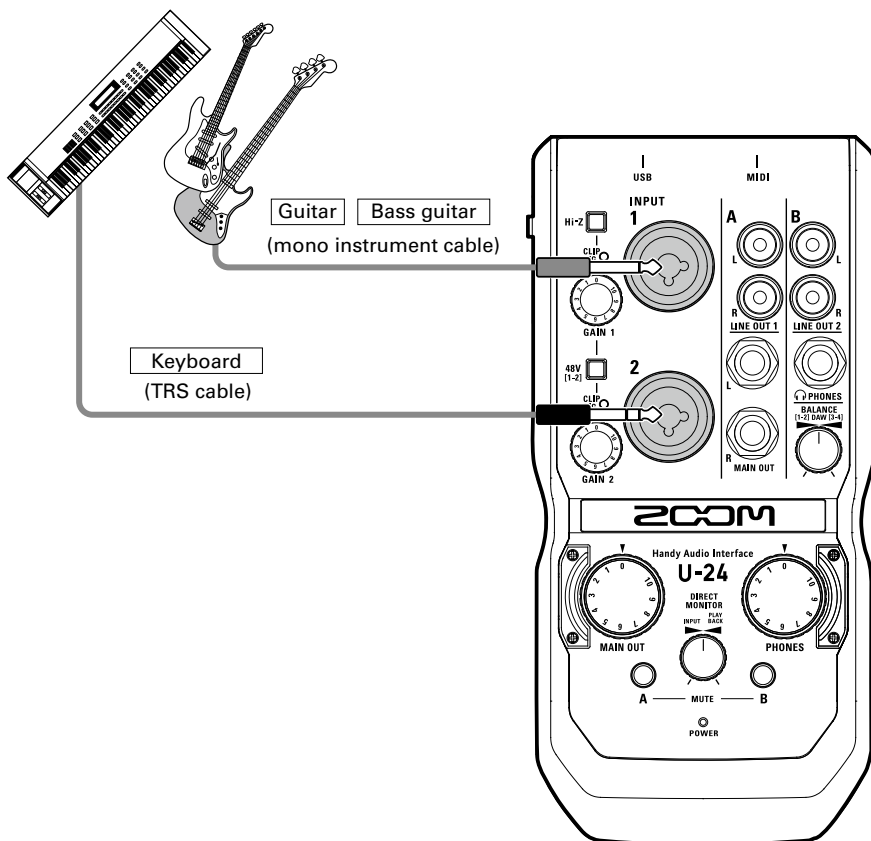

### Using the Hi-Z Function

- The Hi-Z function can only be used with INPUT 1.
- When connecting a guitar or bass with passive pickups, use INPUT 1 and turn HI-Z  on (  ).
- When connecting a keyboard or other instrument, connect it to INPUT 1 and turn HI-Z  off (  ), or connect it to INPUT 2.

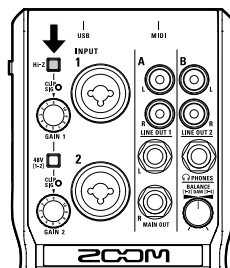

## Connecting Mics

Mics can be connected to INPUTS 1/2 using XLR cables.

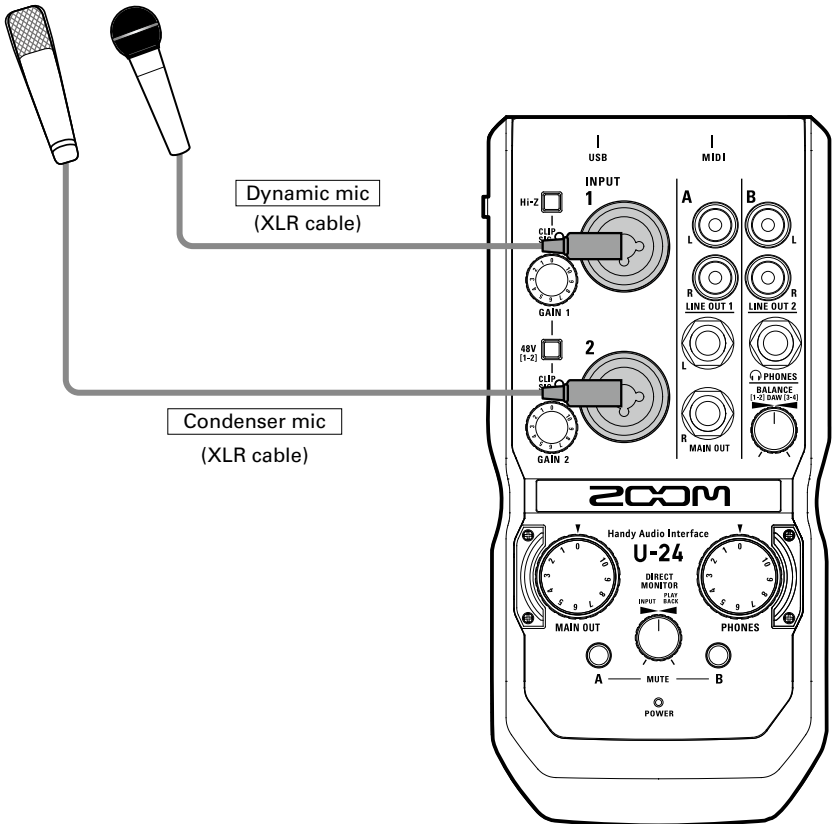

### Using Phantom Power

- When using a condenser mic, turn  $\frac{48V}{[1-2]}$  on (  ).
- When on, phantom power is supplied to both INPUTS 1 and 2.

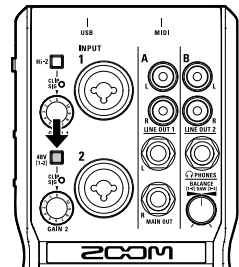

# Adjusting Input Gain

You can adjust the gain of each input.

## 1. Check the status of the input signal.

Green light: Input signal is present.

Red light: Input signal is clipping.

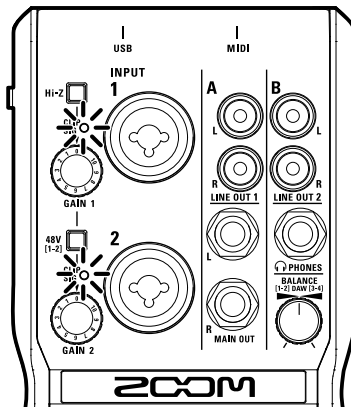

## 2. Adjust the input gain.

Turn the  / .

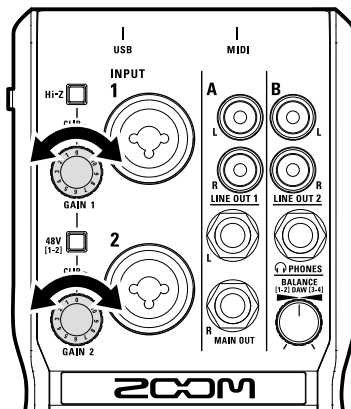

### HINT

- To avoid distorted audio, adjust the input gain so the level indicator doesn't light up red.

# Connecting Headphones and Speakers

Connect headphones to the PHONES jack, speakers to the MAIN OUT jacks, and adjust the volume levels accordingly.

## 1. Connect headphones or speakers.

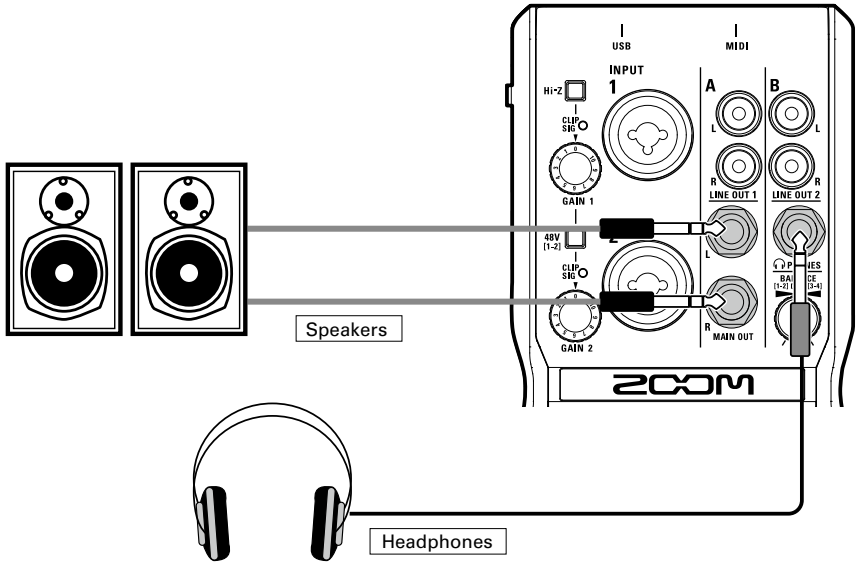

## 2. Adjust the headphones/speakers volume.

Headphones volume: Turn PHONES.

Speakers volume: Turn MAIN OUT.

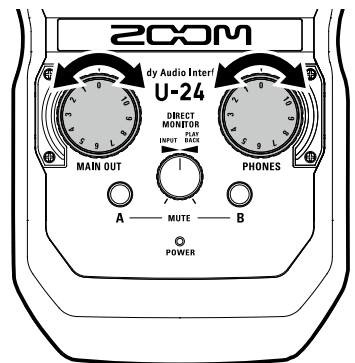

### NOTE

- The LINE OUT 1 jacks deliver the same signal output as the MAIN OUT jacks.
- The LINE OUT 2 jacks deliver the same signal output as the PHONES jack.
- The LINE OUT 1 and 2 volume levels can't be changed.
- The MAIN OUT/LINE OUT 1 jacks deliver output from computer playback signals 1-2.
- The PHONES/LINE OUT 2 jacks deliver output from the adjusted balance of computer playback signals 1-2 and 3-4. (→ P. 17)

# Muting Outputs

The outputs of channels A (MAIN OUT/LINE OUT 1) and B (PHONES/LINE OUT 2) can be muted/unmuted.

1. Press  for the channel you want to mute.

Lit: Muted

Unlit: Not muted

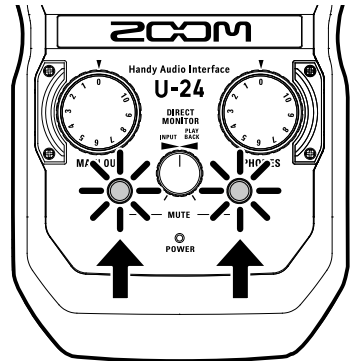

## Using Direct Monitoring

Direct monitoring enables you to listen to input signals before they pass through the computer. This allows you to hear the sound coming into the **U-24** without latency.

1. Turn  to adjust the balance between the **U-24** audio input and the computer playback signals.

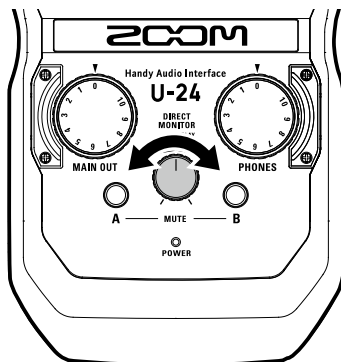



# Adjusting the Computer Playback Signal Balance

The balance between computer playback signals 1-2 and 3-4 can be adjusted for the LINE OUT 2 and PHONES outputs.

For example, you can balance the PHONES output between click track and MAIN OUT signals during a live performance. Or you can balance between the cue and MAIN OUT signals during a DJ performance.

## Live performance

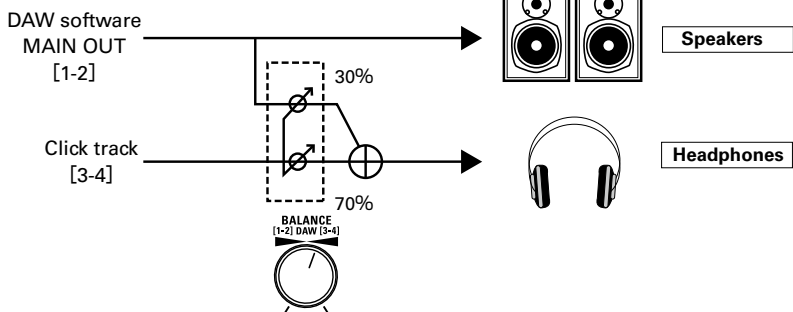

## DJ performance

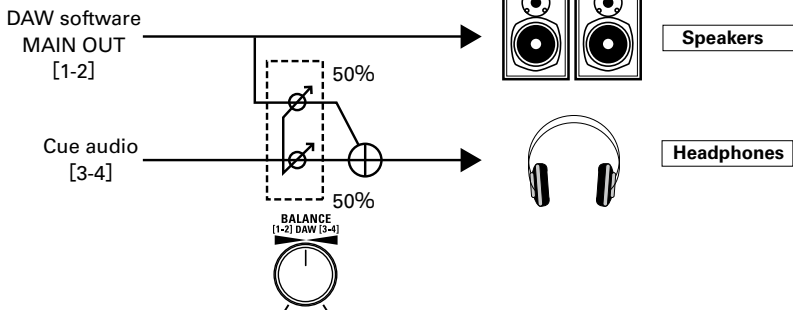

1. Turn  to adjust the balance between computer playback signals 1-2 and 3-4.

### NOTE

- Computer playback signals 1-2 are output from the MAIN OUT/LINE OUT 1 jacks.

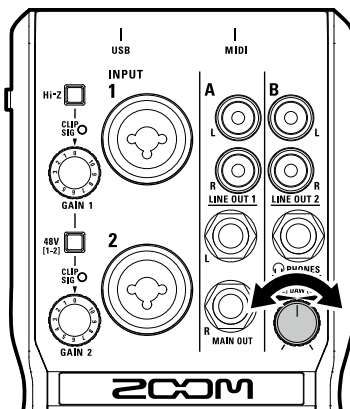

# Connecting MIDI Devices

Use MIDI cables to connect MIDI devices to the MIDI IN and MIDI OUT jacks.

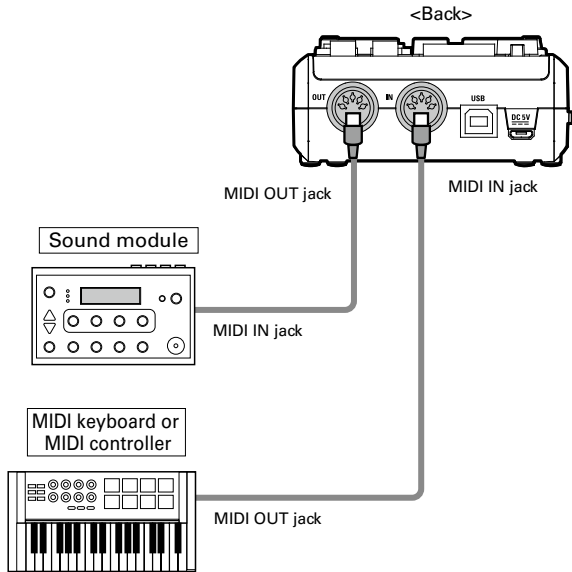

**NOTE**

- When you connect the **U-24** to a DAW using a MIDI port, follow the instructions below to ensure proper connectivity and functionality.
  - <Windows>  
Use ZOOM U-24 Driver. Do not use MIDI IN/OUT 2 (ZOOM U-24 Driver).
  - <Mac>  
Use ZOOM U-24 MIDI I/O Port. Do not use ZOOM U-24 Reserved Port.

# Troubleshooting

## Cannot select or use the U-24 device

- Confirm that the **U-24** is connected to the computer correctly.
- Quit all the software that is using the **U-24**, and disconnect and reconnect the USB cable connected to the **U-24**.
- Reinstall the driver.
- Connect the **U-24** directly to a USB port on the computer. Do not connect it to a USB hub.

## Playback sound cannot be heard or is quiet

- Check the speaker connections and volume settings on the speakers.
- Adjust the OUTPUT and PHONES volume controls.
- Confirm that the Sound setting of the computer that you are using is set to "ZOOM U-24".
- Adjust the DIRECT MONITOR knob.
- If no sound can be heard or the volume is low from the PHONES/LINE OUT 2 outputs, adjust the BALANCE knob.

## Recorded audio is too loud, too quiet or silent

- Adjust the input gain of the **U-24**.
- When using a condenser mic, turn phantom power on.
- Confirm that the Sound setting of the computer that you are using is set to "ZOOM U-24".

## The sound of the device connected to the input jack is distorted

- Confirm that the level indicators are not lighting red. If they are, lower the input levels.

## Sound skips during playback or recording

- If you can adjust the audio buffer size of the software that you are using, increase the buffer size.
- Turn the automatic sleep function and other computer power saving settings OFF.
- Connect the **U-24** directly to a USB port on the computer. Do not connect it to a USB hub.

## Cannot play or record

- Confirm that the Sound setting of the computer that you are using is set to "ZOOM U-24".
- Confirm that **U-24** is set for input and output in the software you are using.
- Confirm that **U-24** is connected to the computer correctly.
- Quit all software that is using the **U-24**, then disconnect and reconnect the **U-24**'s USB cable.

## Cannot use with an iOS device

- Confirm that the batteries are loaded or the external power supply is connected correctly. (→ P. 7)
- Set the POWER switch to BATTERY/DC IN to turn the power on.

# Specifications

<b>ANALOG IN</b>	INPUT 1/2	Connector	TRS/XLR combo jacks (XLR: 2 hot, TRS: TIP hot)
		Input gain	0 – 43 dB
		Input impedance	2.6 k $\Omega$ (MIC IN) 1.1 M $\Omega$ (when HI-Z ON)
		Maximum input level	+2.7 dBu (MIC IN)/+20.7 dBu (TRS IN)
		Phantom power	+48 V
<b>ANALOG OUT</b>	MAIN OUT L/R	Connector	TRS phone jacks (unbalanced)
		Maximum output level	+10 dBu (at 0 dBFS)
		Output impedance	330 $\Omega$
	LINE OUT 1/2	Connector	RCA (coaxial)
		Maximum output level	+8 dBu (at 0 dBFS)
		Output impedance	1 k $\Omega$
	PONES	Connector	Standard stereo phone jack 30 mW x 2 (into 32 $\Omega$ load)
		Maximum output level	+10 dBu (at 0 dBFS)
		Output impedance	33 $\Omega$
<b>Frequency characteristics</b>		At 44.1 kHz: -1.0 dB: 20 Hz - 20 kHz At 96 kHz: -3.5 dB: 20 Hz - 40 kHz	
<b>Input conversion noise</b>		Measured EIN: -119.5 dB (IHF-A) (with 43 dB, 150 $\Omega$ input)	
<b>Number of audio recording and playback channels</b>		Recording: 2 channels Playback: 4 channels	
<b>Sampling frequencies</b>		96 kHz, 88.2 kHz, 48 kHz, 44.1 kHz	
<b>Bit depth</b>		24 bit	
<b>Interface</b>		USB2.0	
<b>MIDI IN/OUT</b>		5 pin DIN jack	
<b>Power Source</b>		USB bus power (Type B)/ZOOM AD-17 (Micro-B)/DC 5 V power supply (Micro-B)/2 AA batteries (about 4 hours continuous operation with phantom power off)	
<b>Power consumption</b>		5 W maximum	
<b>Dimensions</b>		191.8 mm (D) x 92.3 mm (W) x 42.7 mm (H)	
<b>Weight (main unit only)</b>		285 g	

\* 0 dBu = 0.775 Vrms

Note: The continuous operation time with batteries is just an estimate. This result is from in-house testing methods. The actual time will vary greatly according to operating conditions.

# Signal Flow Diagrams

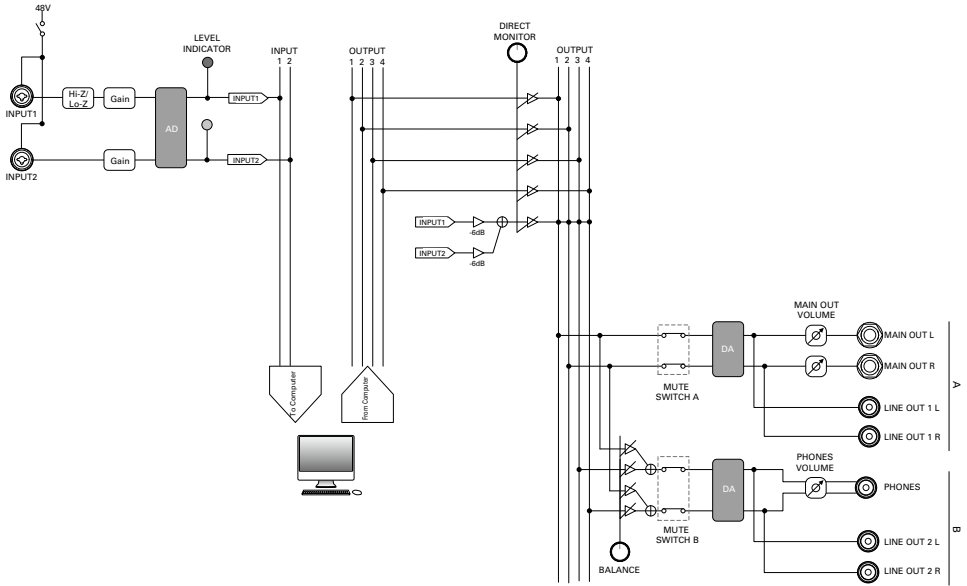





**ZOOM<sup>®</sup>**

**ZOOM CORPORATION**

4-4-3 Kandasurugadai, Chiyoda-ku, Tokyo 101-0062 Japan  
<http://www.zoom.co.jp>