

TASCAM

D01392520B

Portacapture X8

Linear PCM Recorder

Reference Manual

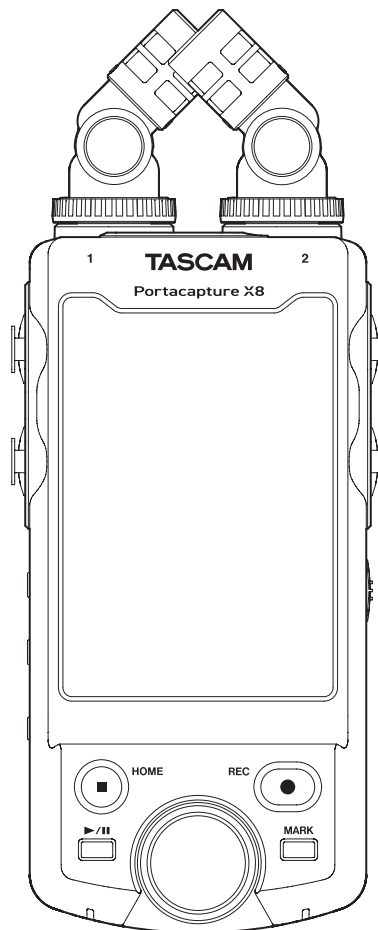

Contents

1 - Introduction	5	5 - Input and output settings	26
1-1 Overview.....	5	5-1 Using the INPUT SELECT function.....	26
1-2 Features.....	5	5-2 Making input settings for each input.....	27
1-3 Conventions used in this manual.....	6	Using the STEREO LINK function.....	27
1-4 Trademarks and copyrights.....	6	Setting recording input sources (INPUT).....	27
1-5 microSD cards.....	7	Using phantom power (PHANTOM).....	27
Precautions for use.....	7	Adjusting the input level automatically (AUTO GAIN).....	27
Note about formatting.....	7	Setting the low-cut filter (LOW CUT).....	28
1-6 Accessories sold separately.....	7	Setting the noise gate (NOISE GATE).....	28
USB cables (for communication or data transmission).....	7	Setting the limiter (LIMITER/COMP).....	28
PS-P520U AC adapter.....	7	Setting the equalizer (EQ).....	28
AK-BT1 Bluetooth adapter.....	7	Inverting the input phase (PHASE INVERT).....	29
		Adjusting input gain (GAIN).....	29
		Changing the input gain (GAIN).....	29
2 - Names and functions of parts	8	5-3 Adding reverb to inputs (REVERB).....	29
2-1 Front.....	8	5-4 Setting the phantom power voltage.....	29
2-2 Bottom.....	8		
2-3 Left side.....	9	6 - Recording apps	30
2-4 Right side.....	9	6-1 Recording app overview.....	30
2-5 Rear.....	9	Recording guide function (MANUAL app only).....	30
2-6 Using the wheel.....	10	Recording pause function.....	30
2-7 Using the touchscreen.....	10	Recording operation flow.....	31
Basic screen operations.....	10	6-2 Button operations during recording.....	32
2-8 App overview.....	11	6-3 Recording with the ASMR app.....	33
LAUNCHER screen.....	11	Setting procedures.....	33
Recording app signal flows.....	12	Screen overview.....	33
Recording app output files.....	13	Shortcut Menu.....	33
INPUT SELECT function.....	14	Setting input levels.....	33
Project status bar.....	15	Recording.....	34
Shortcut Menu.....	16	Starting playback.....	34
Character input.....	17	6-4 Recording with the MANUAL app.....	35
		Setting procedures.....	35
3 - Preparation	18	Screen overview.....	35
3-1 Inserting and removing microSD cards.....	18	Shortcut Menu.....	35
Inserting microSD cards.....	18	Using the wheel.....	35
Removing microSD cards.....	18	Setting input levels.....	35
3-2 Preparing the power supply.....	18	Using the mixer.....	36
Notes about power supplies.....	18	Recording.....	37
Using AA batteries.....	18	Starting playback.....	37
Using an AC adapter (sold separately).....	19	6-5 Recording with the MUSIC app.....	38
Using USB bus power.....	19	Setting procedures.....	38
3-3 Turning the power on and off.....	20	Screen overview.....	38
Turning the power on.....	20	Shortcut Menu.....	38
Turning the unit off (putting it in standby).....	20	Selecting the type of instrument to record.....	38
Resume function.....	20	Setting the input level.....	39
Setting the language, date and time.....	20	Adding reverb to the input (REVERB).....	39
Formatting (initializing) microSD cards.....	21	Recording.....	39
		Starting playback.....	39
4 - Connections	22	6-6 Recording with the VOICE app.....	40
4-1 Connection examples.....	22	Setting procedures.....	40
Using the MANUAL app.....	22	Screen overview.....	40
Using the PODCAST app.....	22	Shortcut Menu.....	40
4-2 Connecting the included mics.....	22	Setting the inputs.....	40
X-Y connection.....	22	Setting the input level.....	40
A-B stereo connection.....	23	Recording.....	41
4-3 Connecting external mics and other equipment.....	23	Starting playback.....	41
Connecting external mics.....	23	6-7 Recording with the FIELD app.....	42
Connecting mics that are compatible with plug-in power.....	23	Setting procedures.....	42
Connecting mid-side mics.....	23	Screen overview.....	42
Connecting other equipment.....	24	Shortcut Menu.....	42
4-4 Connecting cameras.....	24	Setting the inputs.....	42
Setting the output for camera use.....	24	Selecting the recording subject.....	42
4-5 Connecting monitoring equipment.....	24	Setting the input level.....	43
4-6 Using the built-in speaker.....	25	Setting the filter (LOW CUT).....	43
4-7 Adjusting the playback volume.....	25	Recording.....	43
4-8 Connecting computers and smartphones.....	25	Starting playback.....	43

6-8 Recording with the PODCAST app.....	44	Deleting tracks in projects (TRACK DELETE).....	62
Setting procedures.....	44	Enabling and disabling protection (CHANGE PROTECT).....	62
Screen overview.....	44	Changing names (RENAME).....	62
Shortcut Menu.....	44	Viewing the mark list (MARK).....	62
Using the wheel.....	44	Dividing files (DIVIDE).....	63
Setting input levels.....	45	Normalizing recordings (NORMALIZE).....	63
Using the mixer.....	45	9-8 Setting where recording files are saved.....	63
Recording.....	45		
Making sound pad settings.....	46	10- Mark functions 64	
Playing effect sounds during recording.....	47	10-1 Mark types.....	64
Muting mics.....	47	10-2 Adding marks.....	64
Starting playback.....	47	Adding marks manually.....	64
7- Recording settings 48		Adding marks automatically (AUTO MARK).....	64
7-1 Monitoring individual inputs (solo monitoring).....	48	Adding marks when peak levels occur (PEAK MARK).....	64
7-2 Changing the recording file format.....	48	10-3 Deleting marks.....	64
7-3 Recording in mono.....	48	Deleting all marks.....	64
7-4 Pausing during recording (REC PAUSE).....	49	10-4 Jumping to set marks (mark skipping).....	64
7-5 Starting recording automatically (AUTO REC).....	49	10-5 Dividing files at every mark.....	64
7-6 Recording with two settings at the same time (DUAL REC).....	49	10-6 Opening mark lists.....	64
7-7 Capturing a few seconds before starting recording (PRE REC).....	49		
7-8 Adjusting input levels automatically (AUTO GAIN).....	49	11- Camera functions 65	
7-9 Recording file naming.....	49	11-1 Setting the output for camera use.....	65
7-10 Designating the folder use for recordings.....	49	11-2 Using the auto tone function (AUTO TONE).....	65
7-11 Changing files while continuing to record		Setting the AUTO TONE function.....	65
(TIME FILE INCREMENT function).....	49	Adjusting the tone volume.....	65
Automatic.....	49		
Manual.....	49	12- USB connection 66	
7-12 Punch in/out (MANUAL app only).....	50	12-1 Connecting with computers.....	66
Punching in and out.....	50	12-2 Connecting with iOS devices.....	66
Undoing punching in and out (UNDO).....	50	12-3 Accessing microSD cards from a computer.....	66
Canceling UNDO operations (REDO).....	51	Exchanging files with computers.....	66
7-13 Recording times (in hours: minutes).....	51	12-4 Using the ASIO driver.....	66
		12-5 Using as an audio interface.....	66
		Portacapture X8 USB audio channel assignments.....	66
		12-6 Using the unit as a USB mic.....	67
		Inputting sound to the computer using the unit inputs.....	67
		Using the computer output as sound input to this unit.....	67
8- Playing files..... 52			
8-1 Open the playback screen.....	52	13- Other functions and apps 69	
Screen overview.....	52	13-1 METRONOME app.....	69
Playing and pausing.....	52	13-2 TUNER app.....	69
Stopping playback.....	52	Tuning by pitch.....	69
Changing the playback position.....	52	Tuning by standard pitch.....	69
Selecting files for playback.....	52	13-3 Mix down function.....	69
Searching backward and forward.....	52	13-4 Mid-side decoding function.....	70
Adjusting the mix balance of the tracks.....	53	Connection settings.....	70
		Adjusting mid and side levels.....	71
9- File operations 54			
9-1 File name overview.....	54	14- Controller app..... 72	
Changing how files are named.....	56	14-1 Installing the dedicated controller app.....	72
Resetting the file number.....	56	14-2 Connecting with this unit using Bluetooth.....	72
9-2 File and project structure overview.....	57	14-3 Using the dedicated smartphone app.....	72
Folders.....	57		
Recording data.....	57	15- Various settings 73	
9-3 Folder hierarchy example.....	57	15-1 Adjusting gain differences between included mics (mic trim	
9-4 Project overview.....	57	function).....	73
9-5 Using the BROWSE screen.....	58	15-2 XRI function overview.....	73
9-6 Folder operations.....	58	15-3 Showing various information.....	73
Screen overview.....	58	15-4 Resetting the date and time.....	73
Basic operation.....	58	15-5 Resetting the language.....	73
Creating folders (NEW).....	59	15-6 Resetting the unit to its factory defaults.....	73
Changing the names of folders (RENAME).....	59	15-7 Formatting microSD cards.....	73
Deleting all files in a folder (ALL FILES DELETE).....	59	15-8 Using the automatic power saving function.....	73
Deleting folders (FOLDER DELETE).....	59	15-9 Selecting the power source.....	73
9-7 File and project operations.....	60	15-10 Setting the AA battery type (BATTERY).....	73
Basic operation.....	60	15-11 Power saving (energy conservation) mode.....	74
SELECT.....	60	15-12 Adjusting the display contrast (CONTRAST).....	74
Playing master files (PLAY).....	60	15-13 MENU.....	75
Viewing file details (FILE INFORMATION).....	62		
Deleting files and projects (FILE DELETE).....	62		

Contents

GENERAL SETTINGS.....	75
INPUT SETTINGS	77
MIXER.....	77
BROWSE.....	77
INPUT SELECT	78
LAUNCHER.....	78
16 - Messages.....	79
17 - Troubleshooting.....	80
18 - Specifications	82
18-1 Specifications and rated values	82
Recorder specifications.....	82
Analog audio input ratings.....	82
Analog audio output	82
Control input/output ratings.....	82
Audio performance.....	82
Recording times (in hours: minutes).....	83
Computer system requirements.....	83
Other.....	83
18-2 Dimensional drawings	84
18-3 Block diagram.....	85
18-4 Level diagram.....	86

1-1 Overview

This unit has a variety of apps that are suitable for different types of recording.

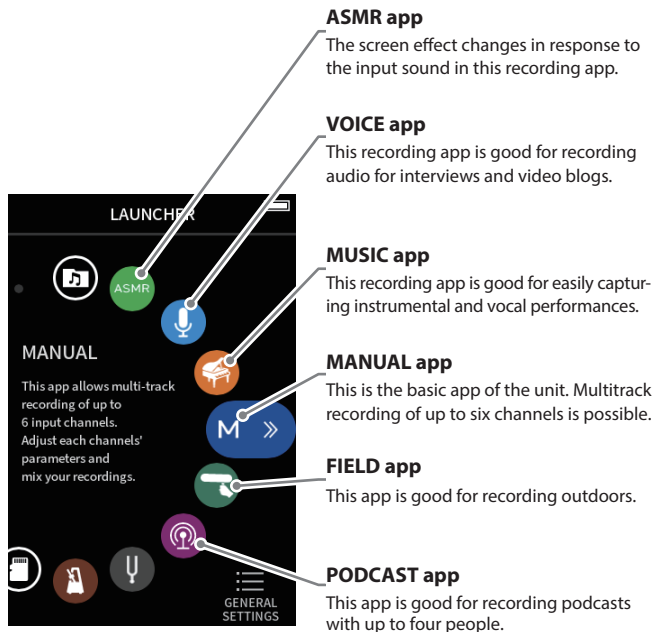

Other apps are useful for music practice.

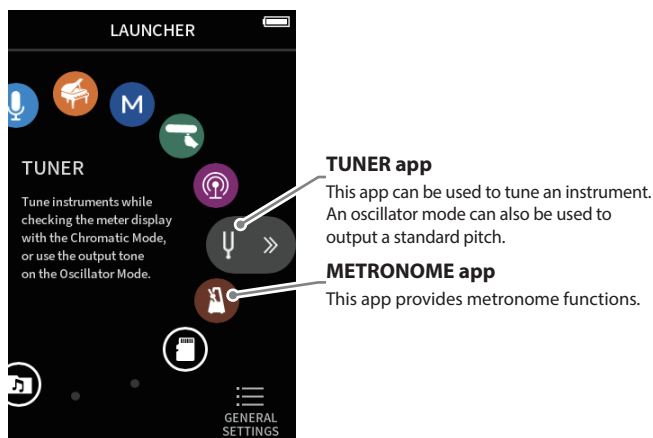

1-2 Features

- 3.5 inch color touch screen provides easy visibility and operation
- Implemented user interface allows support for a variety of different recording scenes such as basic multi-track recordings, podcasts, music, interviews, field recordings, ASMR, etc.
- 4 XLR/TRS locking combo jack inputs to support a variety of scenes that require multiple MIC/LINE connection. Each channel has individual phantom power supply (24V/48V) support.
- Detachable mic unit implemented with large-diaphragm condenser mics
- Both L and R mics can be attached/detached from the main unit to form A-B / X-Y patterns
- Multi-track recording up to 8 tracks (6 tracks + 2-mix)
- Supports up to 192kHz/ 32-bit floating point recording that offers recording data with uncompromised audio quality for later editing on a DAW software.
- Dual recording mode enables each track to be recorded in a different volume level (-12dB) and file format.
- Implemented with a 8-in/2-out USB audio interface function
- Wireless control from a smartphone/tablet can be done using the optional Bluetooth dongle AK-BT1 (sold separately). Time code sync via Bluetooth is also possible. (This feature is to be added in an update soon.)
- Equipped with a variety of functions such as low-cut, compressor, limiter, auto-gain control, noise gate, etc.
- Equipped with a CAMERA/EXT input terminal. Audio recorded on a camera can be monitored. It also supports audio input of wireless microphones and much more.
- Equipped with a CAMERA/LINE output terminal with implemented attenuation function that allows for sending audio to external devices like cameras, etc.
- Audio monitoring is possible with either headphone output or the built-in speaker
- Supports micro SD/micro SDHC/micro SDXC (up to 512GB) recording media
- Equipped with a USB Type-C port that supports USB bus power
- Equipped with Mark function, slate tone function, etc.

1 - Introduction

1-3 Conventions used in this manual

The following conventions are used in this manual.

- “microSD/microSDHC/microSDXC memory card” is sometimes abbreviated as “microSD card”.
- Computers, portable audio devices and other equipment connected to this unit using Bluetooth are called “Bluetooth devices”.
- Files created during a single recording are referred to collectively as a project.
- The project that is currently selected is called the “current project”.
- Information shown on a computer display is written like this: “OK”.
- References to “iOS” in this document also include iPad OS.
- As necessary, additional information is provided under TIP, NOTE and CAUTION headings.

TIP

These are tips about how to use the unit.

NOTE

These provide additional explanations and describe special cases.

CAUTION

Failure to follow these instructions could result in damage to equipment or lost data, for example.

⚠ CAUTION

Failure to follow these instructions could result in injury.

1-4 Trademarks and copyrights

- TASCAM is a registered trademark of TEAC Corporation.
- microSDXC Logo is a trademark of SD-3C, LLC.



- MPEG Layer-3 audio coding technology licensed from Fraunhofer IIS and Thomson.
- Supply of this product does not convey a license nor imply any right to distribute MPEG Layer-3 compliant content created with this product in revenue-generating broadcast systems (terrestrial, satellite, cable and/or other distribution channels), streaming applications (via Internet, intranets and/or other networks), other content distribution systems (pay-audio or audio-on-demand applications and the like) or on physical media (compact discs, digital versatile discs, semiconductor chips, hard drives, memory cards and the like). An independent license for such use is required. For details, please visit <http://mp3licensing.com>.
- Microsoft and Windows are either registered trademarks or trademarks of Microsoft Corporation in the United States and/or other countries.
- Apple, Mac, macOS, iOS, iPad, iPadOS and iTunes are trademarks of Apple Inc. in the United States and other countries.
- App Store is a service mark of Apple Inc.
- Lightning is a trademark of Apple Inc.
- IOS is a trademark or registered trademark of Cisco in the U.S. and other countries and is used under license.
- Android and Google are trademarks of Google LLC.
- ASIO is a trademark and software of Steinberg Media Technologies GmbH.



- Other company names, product names and logos in this document are the trademarks or registered trademarks of their respective owners.

Information is given about products in this manual only for the purpose of example and does not indicate any guarantees against infringements of third-party intellectual property rights and other rights related to them. TEAC Corporation will bear no responsibility for infringements on third-party intellectual property rights or their occurrence because of the use of these products.

Properties copyrighted by third parties cannot be used for any purpose other than personal enjoyment and the like without the permission of the right holders recognized by copyright law. Always use this equipment properly. TEAC Corporation will bear no responsibility for rights infringements committed by users of this product.

1 - 5 microSD cards

A card is necessary to record and play files with this unit. Prepare one for use.

This unit uses microSD cards for recording and playback.

This unit can use microSD cards that are Class 10 or higher and compatible with microSD, microSDHC or microSDXC standards.

A list of microSD cards that have been confirmed for use with this unit can be found on the TASCAM website (https://tascam.jp/int/product/portacapture_x8/docs). Alternatively, please contact TASCAM customer support service.

Precautions for use

microSD cards are delicate media.

In order to avoid damaging microSD cards, take the following precautions when handling them.

- Do not leave them in extremely hot or cold places.
- Do not leave them in extremely humid places.
- Do not let them get wet.
- Do not put things on top of them or twist them.
- Do not hit them.
- Do not remove or insert them during recording, playback, data transmission or other access.
- Always put memory cards in cases when transporting them.

Note about formatting

microSD cards formatted by this unit are optimized to improve performance during recording. Use this unit to format the microSD cards to be used with it. Errors might occur when recording with this unit using a microSD card formatted by a computer or other device.

1 - 6 Accessories sold separately

This product does not include the following items. Please purchase any that you need for your uses.

USB cables (for communication or data transmission)

A USB cable must be prepared to connect this unit to a computer (Windows/Mac) or smartphone.

This unit has a USB Type-C port.

Prepare a USB cable suitable for the USB port of the computer or smartphone being used.

- USB cables designed only for charging cannot be used.

Connecting to an iOS device with a lightning port

A genuine Apple Lightning to USB Camera Adapter and a commercially-available Type-A to Type-C cable are necessary.

Connecting to a computer or smartphone with a USB Type-C port

A commercially-available Type-C to Type-C cable is necessary.

Connecting to a smartphone with a USB micro-B port

A commercially-available micro-B to Type-C cable is necessary.

Connecting to a computer with a USB Type-A port

A commercially-available Type-A to Type-C cable is necessary.

PS-P520U AC adapter

This is necessary to operate this unit using AC power.

NOTE

This unit does not have a battery charging function when using an AC adapter.

AK-BT1 Bluetooth adapter

This is necessary to control this unit from a smartphone or tablet using Bluetooth connection.

2- Names and functions of parts

2-1 Front

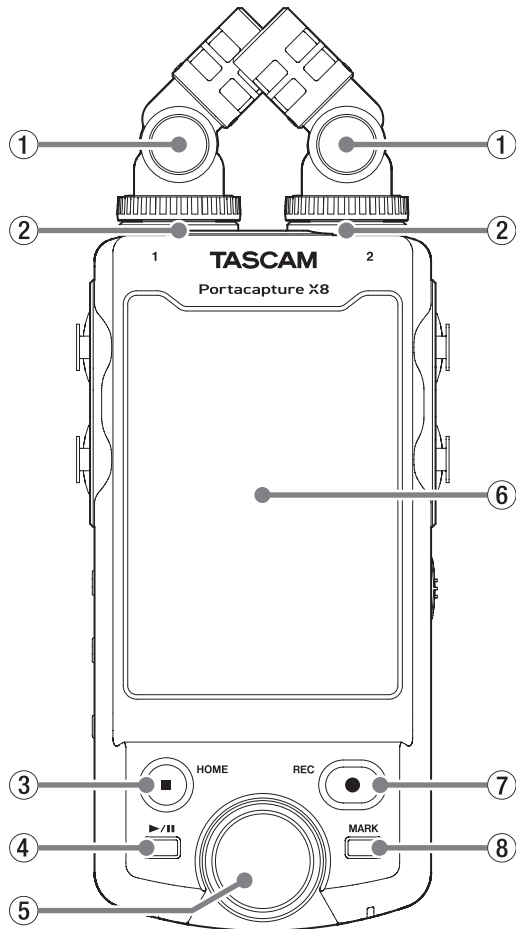

① Included mics

This is a stereo pair of electret condenser mics. They can be connected in two ways. (page 22)

② Input jacks 1/2

Connect the included mics or other mics that are compatible with plug-in power (3.5mm TRS) here.

③ HOME [■] button

Press during playback to stop playback and set the playback position to the beginning of that file.

Press this when recording or paused to stop recording and return to the HOME screen.

When the GENERAL SETTINGS screen is open, press this to return to the LAUNCHER screen.

④ ▶/|| button

Press when stopped to start playback.

Press during playback to pause.

Press when a file is selected on the Browse Screen to play that file.

⑤ Wheel

Use this to make fine adjustments to mixer fader and input level settings.

⑥ Touchscreen

This shows a variety of information.

Tap it and swipe it to make settings and operate the unit. (page 10)

⑦ REC [●] button

Press when stopped to start recording.

Press when recording to put the unit in recording standby.

The function changes according to the RECORDING GUIDE and REC PAUSE settings. See "Recording operation flow" on page 31 for details.

⑧ MARK button

Press when recording or playing back to add marks manually.

2-2 Bottom

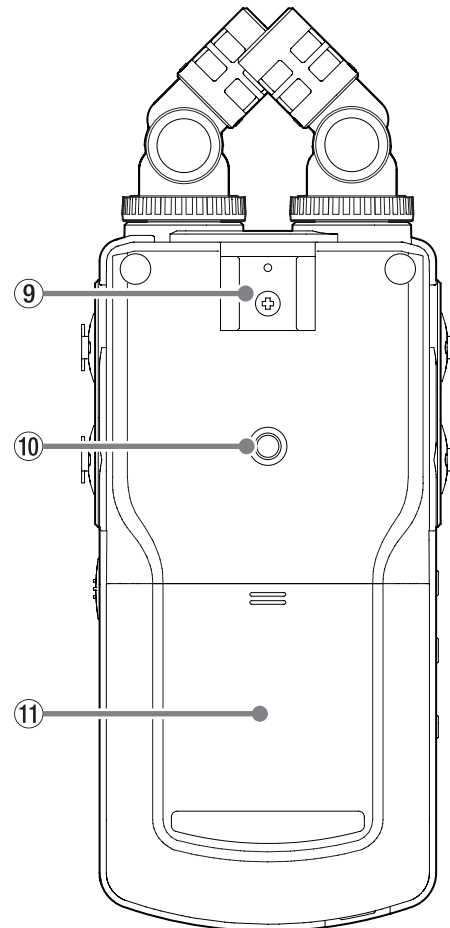

⑨ Accessory shoe

⑩ Tripod mounting threads (1/4-inch)

Use to attach this unit to a tripod.

CAUTION

- Ensure the tripod or mic stand screw is securely fastened to prevent the unit from falling.
- When attaching this unit to a tripod or mic stand, be sure to place it on a level surface.
- Some tripods have different screw specifications that make direct connection impossible. Use a commercially-available adapter with such tripods.
- Screws that are longer than 4.5 mm cannot be used for attachment.

⑪ Battery compartment (AA batteries)

Install four AA batteries in this compartment to power the unit.

2-3 Left side

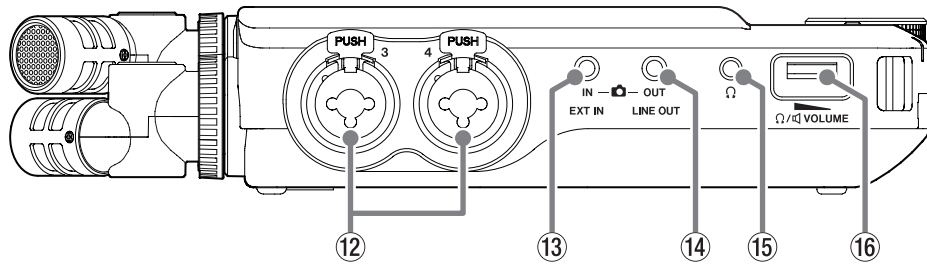

12 Input jacks 3/4

These are balanced analog XLR mic/standard TRS input jacks.
XLR (1: GND, 2: HOT, 3: COLD)
TRS (Tip: HOT, Ring: COLD, Sleeve: GND)

13 EXT IN jack

Use a stereo mini jack cable to connect this to the line output jack of an audio device, for example.

14 LINE OUT jack

Use this to connect with the line input jack of an amp or other equipment.

15 Ω (headphone) jack

Connect headphones to this jack.

16 Ω/Ω (headphone/speaker) volume

Use this to adjust the volume output from the built-in speaker or the Ω (headphone) jack.

2-4 Right side

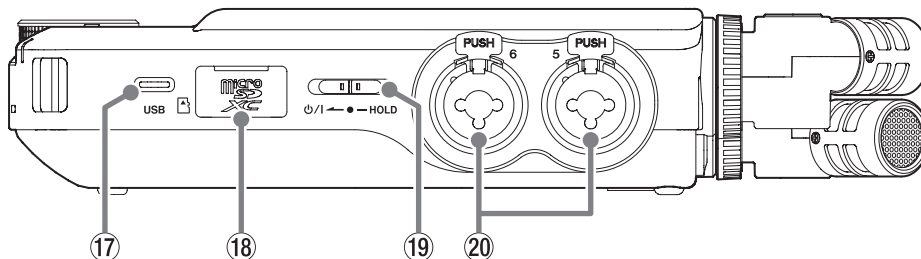

17 USB Type-C port

This is a Type-C USB port.
Use a commercially-available USB cable to connect a computer or smartphone. (page 25)
Power can be supplied to the unit through the USB port.
When using an AC adapter, connect it to this port. (page 19)

18 microSD card slot

Insert microSD cards into this slot.

19 ⏻/I/HOLD switch

Slide this switch toward the ⏻/I icon to turn the unit on and off (put it into standby). Set it to the HOLD position to activate the hold

function. Neither the touchscreen nor any buttons can be used when HOLD is active.

⚠ CAUTION

Before turning the unit on, lower the volumes of connected equipment to their minimum levels.

Failure to do so might cause sudden loud noises, which could harm hearing or result in other trouble.

20 Input jacks 5/6

These are balanced analog XLR mic/standard TRS input jacks.
XLR (1: GND, 2: HOT, 3: COLD)
TRS (Tip: HOT, Ring: COLD, Sleeve: GND)

2-5 Rear

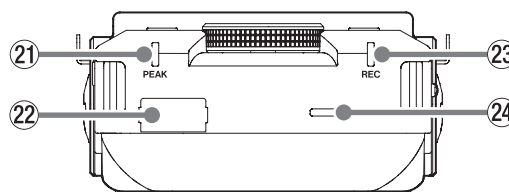

21 PEAK indicator

This lights when the input level exceeds the peak level.

22 Bluetooth device connector

Connect an AK-BT1 Bluetooth adapter (sold separately) here.

23 REC indicator

This blinks when in recording standby and lights when recording.

24 Built-in speaker (mono)

Use this built-in speaker to listen to recordings.
Sound will not be output from the speaker in the following conditions.

- GENERAL SETTINGS screen > I/O SETTINGS page > SPEAKER item set to OFF
- When not playing back
- When headphones are connected

2 - Names and functions of parts

2-6 Using the wheel

After tapping a fader or knob on the touchscreen, turn the wheel left or right to change the setting precisely.

This is convenient for precise adjustments after making rough value changes by sliding.

2-7 Using the touchscreen

Basic screen operations

Functions can be set and adjusted by tapping, swiping and sliding on the touchscreen of this unit.

The first time the unit is started, after setting the language, date and time, the LAUNCHER screen will open.

The LAUNCHER screen can be used to launch various recording apps and setting screens.

Launching recording apps

- As shown in the illustration below, slide the middle of the screen to select an app to launch.

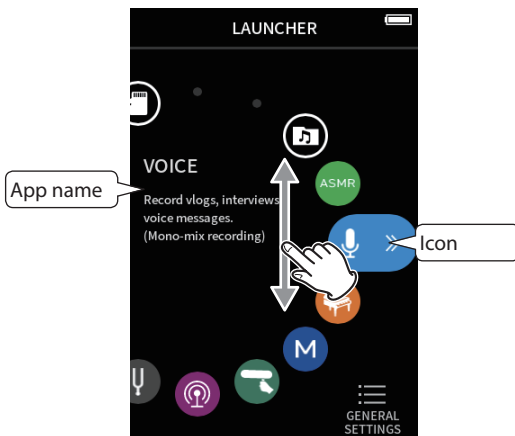

- Tap an icon to launch its app.

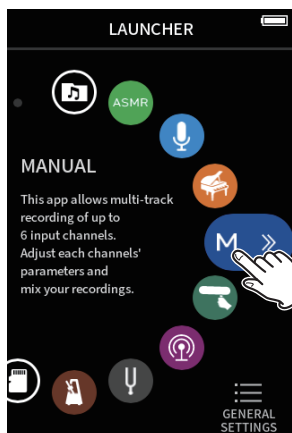

The recording app HOME screen will open.

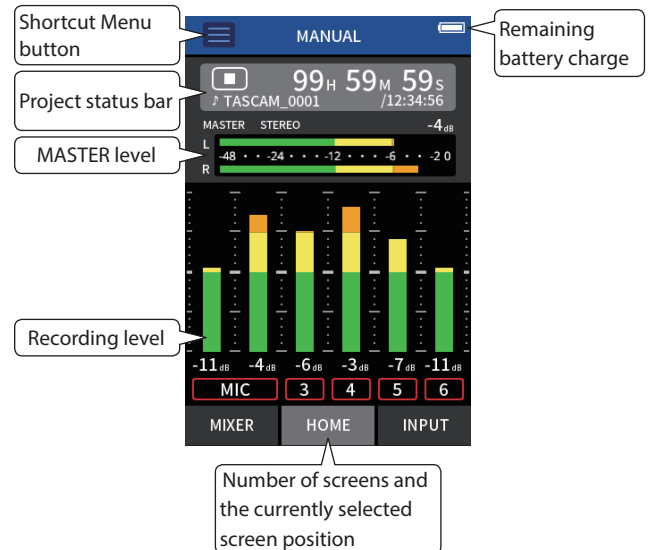

MANUAL recording app example

Returning to the LAUNCHER screen

- Tap the Shortcut Menu button at the top of the screen.



The Shortcut Menu will open at the bottom of the screen.

- Tap the LAUNCHER icon in the Shortcut Menu.

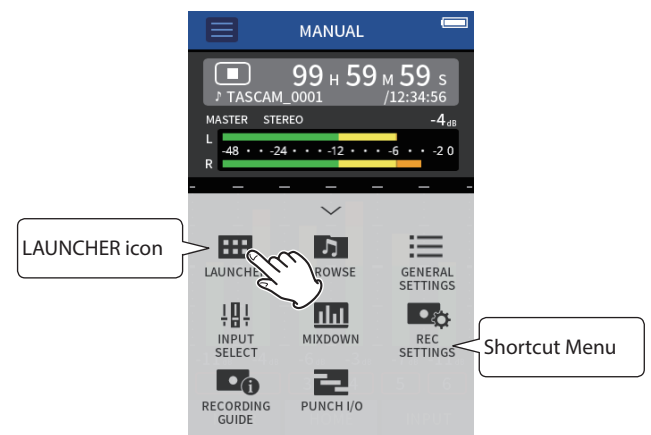

This reopens the LAUNCHER screen.

Switching screens

Tap the name of the screen at the bottom of the display to switch to it.

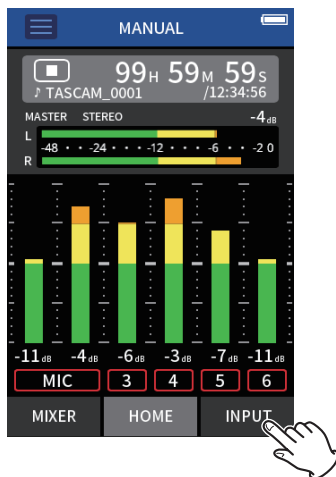

2-8 App overview





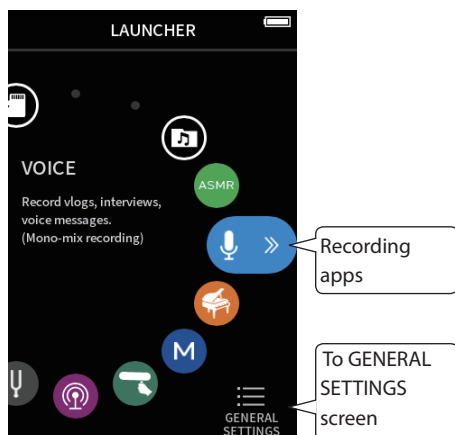

LAUNCHER screen

This can be used to launch recording apps and to open the GENERAL SETTINGS screen.







Recording apps

The following apps for typical recording situations are available.

ASMR 	The screen effect changes in response to the input sound in this recording app. (2-channel recording app)
MANUAL 	This is the basic app of the unit. Multitrack recording of up to six channels is possible.
MUSIC 	This recording app is good for easily capturing instrumental and vocal performances. (2-channel recording app)
VOICE 	This recording app is good for recording audio for interviews and video blogs. (2-channel recording app)
FIELD 	This app is good for recording outdoors. (2-channel recording app)
PODCAST 	This app is good for recording podcasts with up to four people.

Other apps

TUNER 	This app can be used to tune an instrument. An oscillator mode can also be used to output a standard pitch.
METRONOME 	This app provides metronome functions.
BROWSE 	This can be used to select folders and files for playback, deletion and other operations.
SD CARD READER 	This unit can be used as an SD card reader by connecting it to a computer with a USB cable.

NOTE

The designs and functions of apps and other features could change with firmware updates.

GENERAL SETTINGS screen

Use this to make specific unit settings.

Tap the GENERAL SETTINGS icon at the bottom right of the LAUNCHER screen.

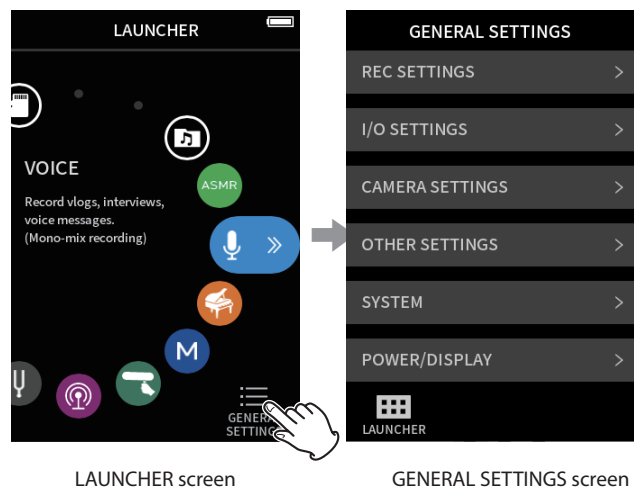

See "GENERAL SETTINGS" on page 75 for a list of setting items.

2 - Names and functions of parts

Recording app signal flows

This unit is capable of multi-track recording with up to 8 tracks (6 tracks + stereo mix). In each app, a maximum of 8 inputs can be assigned to up to 6 tracks. Tracks 1–6 can be used in the MANUAL app, tracks 1–4 can be used in the PODCAST app, and tracks 1–2 can be used in 2-channel recording apps.

- Input jacks 5–6 and the EXT IN jack cannot be used at the same time.

M MANUAL app

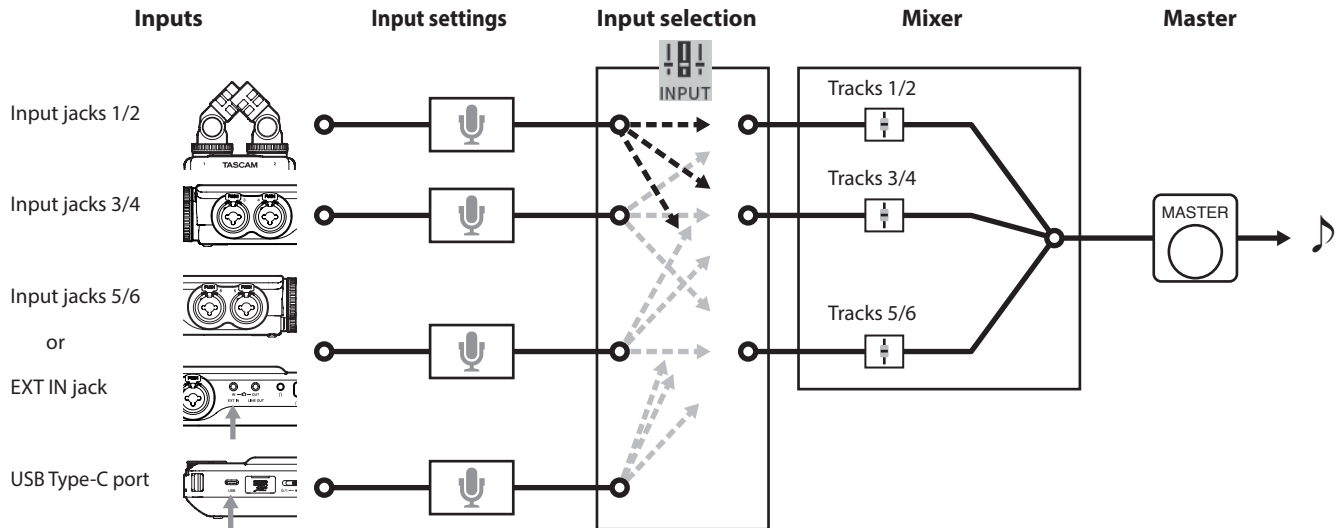

ASMR app MUSIC app VOICE app FIELD app (2-channel recording apps)

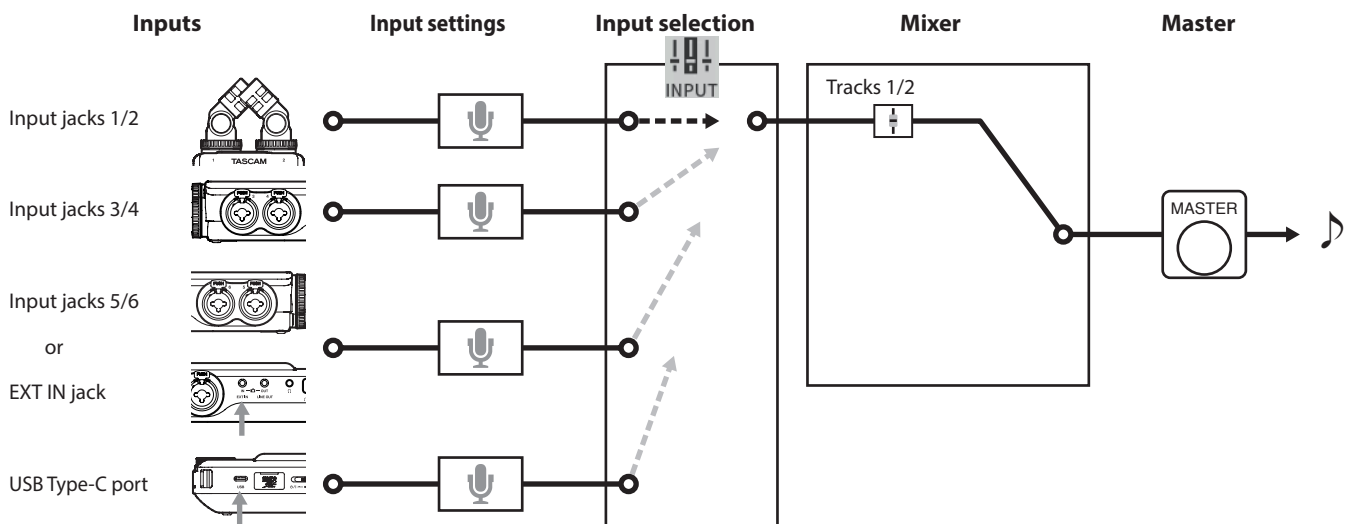

PODCAST app

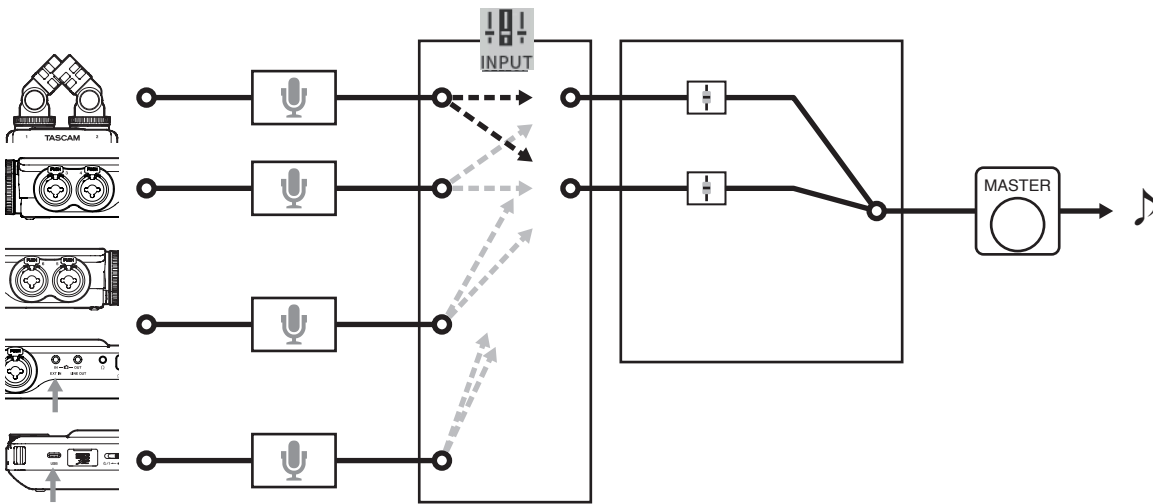

Recording app output files

The types of files produced by recording depend on the app.
Apps capable of multi-track recording produce a master file as well as track files.

M MANUAL app

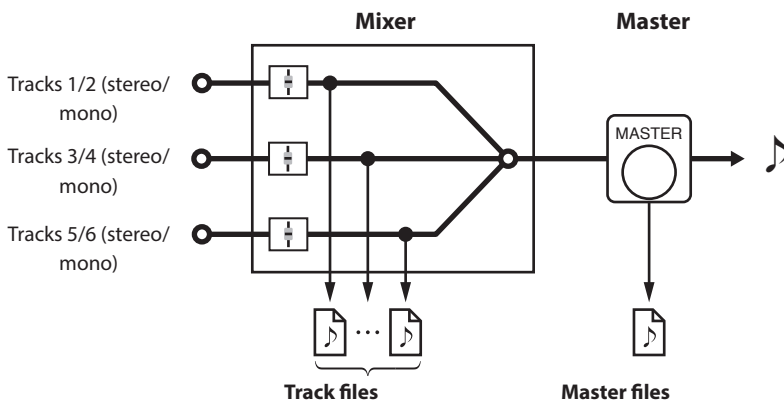

ASMR app MUSIC app VOICE app FIELD app (2-channel recording apps)

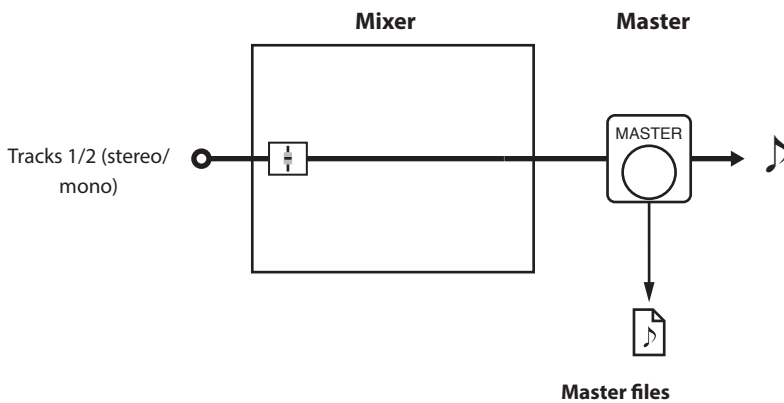

ASMR, MUSIC, FIELD: Stereo files
VOICE: Mono files

2 - Names and functions of parts

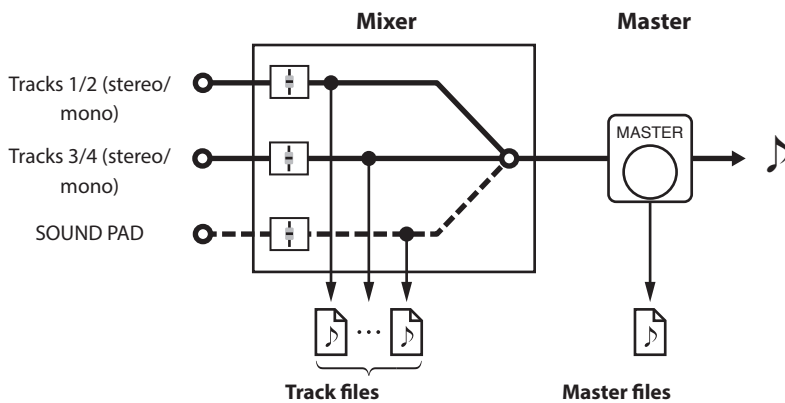

- The podcast app cannot use tracks 5–6.

Track files

These are mono recording files of audio from each track. Two tracks that are stereo-linked are recorded as single stereo files.

Master files

These files are recordings of the mixer output.

INPUT SELECT function

When the unit is shipped new, input jacks 1–6 are assigned to tracks 1–6 by default.

Using the INPUT SELECT function, any pair of input jacks can be assigned to any pair of tracks.

In this example, mics are connected to input jacks 3–4 and assigned to tracks 1–2 for recording using the MUSIC app.

Operation example: assigning input jacks 3–4 to tracks 1–2

Tap the Shortcut Menu button on the app screen, and tap the INPUT SELECT icon to open the INPUT SELECT screen.

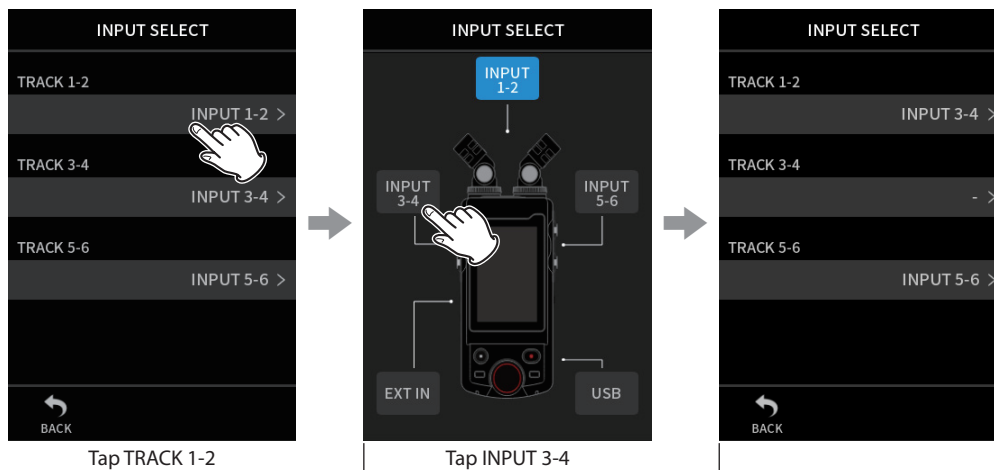

See "Using the INPUT SELECT function" on page 26 for details.

NOTE

- Input jacks 5/6 and the EXT IN jack cannot be used at the same time.
- Input selections are saved independently for each app.

Project status bar

When an app is launched, its HOME screen will show the status of the unit, the counter and other information.

In apps that have multiple screens, this data will be abbreviated on screens other than the HOME screen.

Tapping the project status bar on the HOME screen will show details.

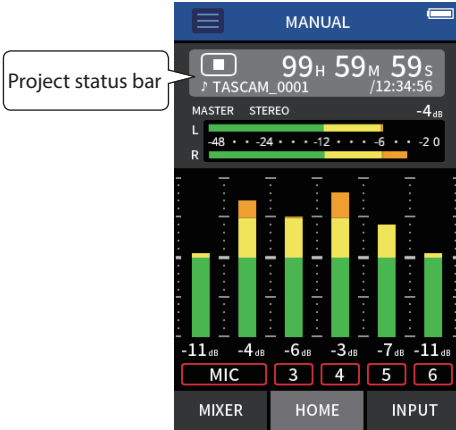

Project status bar

MANUAL recording app example

Showing details

Tap the project status bar to show additional details.

When additional details are shown, tap the file format area to restore the normal display.

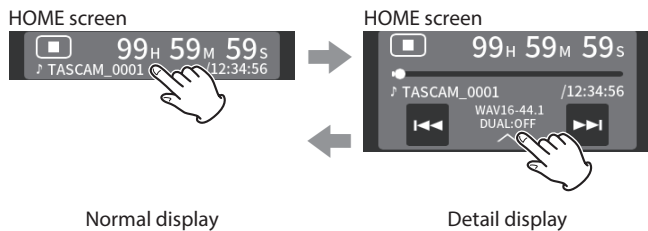

Normal display

Detail display

When stopped

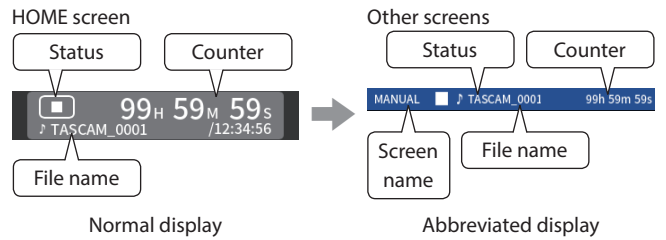

Normal display

Abbreviated display

When recording/recording paused



Normal display

Abbreviated display

When playing/playback paused

Normal display

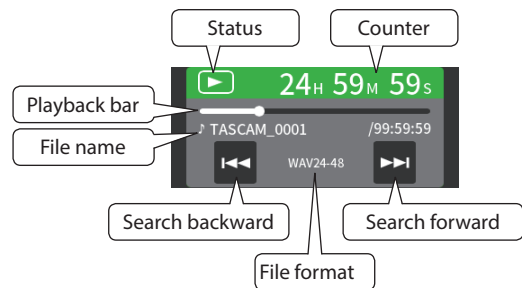

Abbreviated display

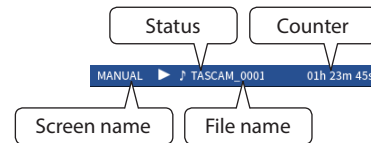









Meaning

State	Status icon	Counter	File format
Stopped	■	File remaining time/recordable time	According to recording settings
Recording	●	Recording time/recordable time	According to recording settings
Recording paused	●	Recording time/recordable time	According to recording settings
Playing	▶	Playback position/remaining playback time	According to the playback file
Paused		Playback position/remaining playback time	According to the playback file

2 - Names and functions of parts

Shortcut Menu

Tap the Shortcut Menu button on the app screen to show various menu shortcuts.

ASMR	VOICE	MUSIC	MANUAL	FIELD	PODCAST	TUNER	METRONOME
							
LAUNCHER	LAUNCHER	LAUNCHER	LAUNCHER	LAUNCHER	LAUNCHER	LAUNCHER	LAUNCHER
BROWSE	BROWSE	BROWSE	BROWSE	BROWSE	BROWSE		
REC SETTINGS	REC SETTINGS	REC SETTINGS	REC SETTINGS	REC SETTINGS	REC SETTINGS		
INPUT SELECT	INPUT SELECT	INPUT SELECT	INPUT SELECT	INPUT SELECT	INPUT SELECT		
INPUT SETTINGS	INPUT SETTINGS					INPUT SETTINGS	
			RECORDING GUIDE				
			MIX DOWN				
			PUNCH I/O				
GENERAL SET-TINGS	GENERAL SET-TINGS	GENERAL SET-TINGS	GENERAL SET-TINGS	GENERAL SET-TINGS	GENERAL SET-TINGS		

LAUNCHER

This opens the LAUNCHER screen.

BROWSE

The opens the BROWSE screen.

REC SETTINGS

This moves to the REC SETTINGS item on the GENERAL SETTINGS screen.

INPUT SELECT

The opens the INPUT SELECT screen.

INPUT SETTINGS

This opens the INPUT screen.

RECORDING GUIDE

This turns the RECORDING GUIDE function on and off.

MIX DOWN

Mix recordings down.

PUNCH I/O

Use punch in/out functions.

GENERAL SETTINGS

Use this to make specific unit settings.

Character input

Tap an item for character input to open the character input screen.
The following example shows the character input screen opened from the GENERAL SETTINGS screen > SYSTEM page > FILE NAME > WORD EDIT item.

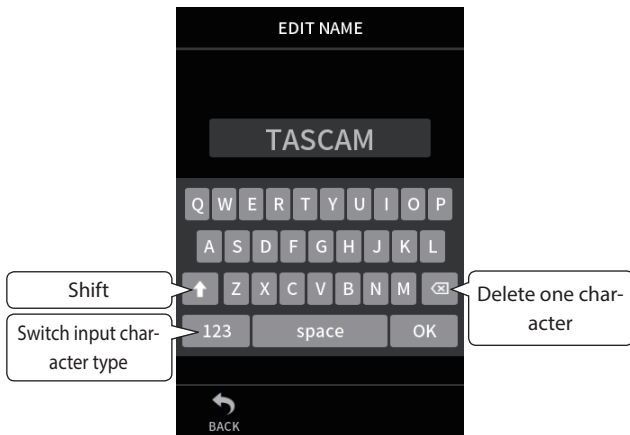

Tap the character type button to switch between letters of the English alphabet and numbers/symbols.

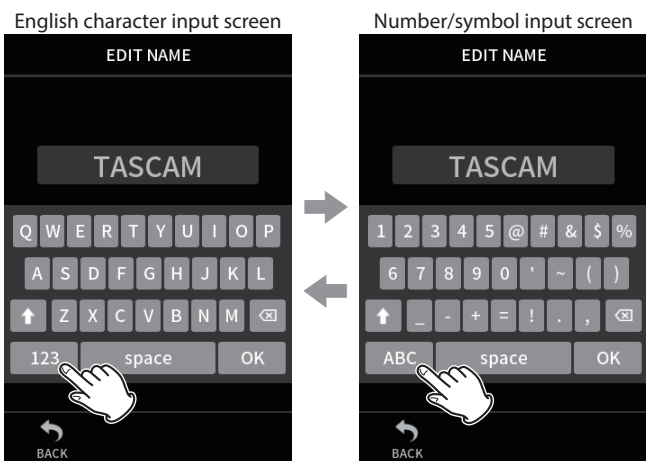

Tap the Shift button to switch between upper and lower case letters.
The following symbols can be input.

@ # & \$ % ' ~ () _ - + = ! . ,

3- Preparation

3-1 Inserting and removing microSD cards

Inserting microSD cards

Insert a microSD card into the microSD card slot on the right side to enable playback and recording by this unit.

NOTE

microSD cards can be inserted when the unit is on or off.

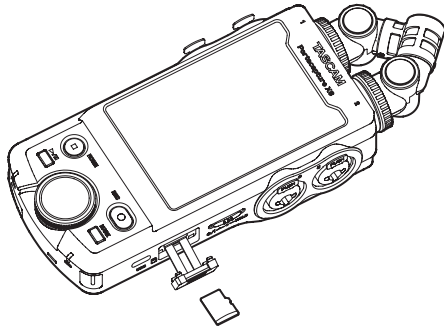

1. Open the microSD slot cover.
2. Insert the microSD card label side up.
3. Close the microSD slot cover.

Removing microSD cards

Turn the unit off or stop operation before removing a microSD card.

CAUTION

Never remove a microSD card when the unit is operating (including recording, playing back, or writing data to the microSD card). Doing so could cause proper recording to fail, data to be lost, and sudden loud noises from monitoring equipment, which might damage the equipment, harm hearing or cause other trouble.

1. Press the microSD card in gently to make it to come out.
2. Pull the microSD card out.

3-2 Preparing the power supply

Notes about power supplies

This unit can be powered by 4 AA batteries, a TASCAM PS-P520U AC adapter (sold separately) or the included USB cable (USB bus power). Alkaline, Ni-MH or lithium AA batteries can be used.

NOTE

This unit does not have a battery charging function when using an AC adapter.

Using AA batteries

1. Remove the battery compartment cover, and install 4 AA batteries with their ⊕ and ⊖ marks as shown in the battery compartment.
2. Reattach the battery compartment cover.

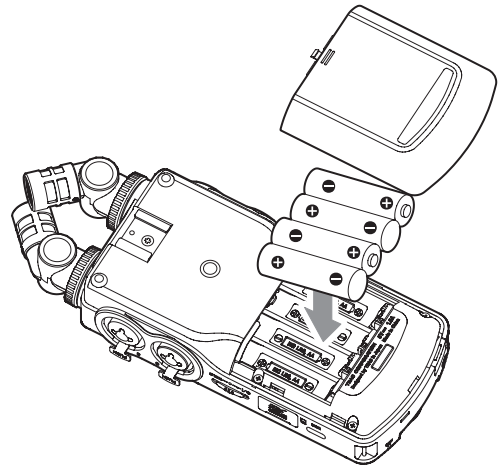

Set the type of battery in order to show the amount of power remaining and allow the unit to determine whether enough power is available for proper operation. ("Setting the AA battery type (BATTERY)" on page 73)

NOTE

The included alkaline batteries are for confirming operation of the unit. For this reason, they might not last very long.

Using an AC adapter (sold separately)

Connect a PS-P520U AC adapter (sold separately) to the unit's USB port.

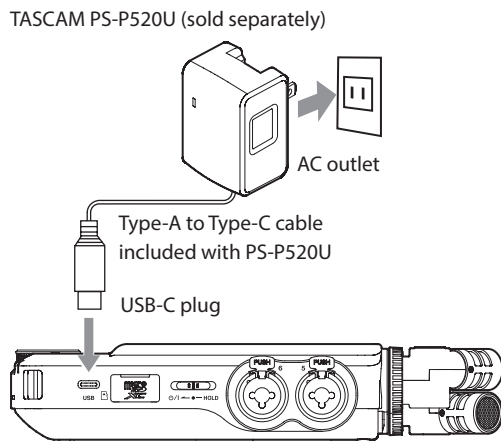

CAUTION

- We highly recommend using the AC adapter designed for use with this unit (PS-P520U sold separately). When using another external power supply device, use one with the following specifications.
 - Supplied voltage: 5 V
 - Supplied current: 1.5A or more

Using a power supply device with specifications other than the above could cause malfunction, overheating, fire or other problems.

If trouble should occur, stop using the unit and contact the retailer where you purchased it or a TASCAM customer support service to request repair.

- Noise may occur when recording with a microphone if the unit is too close to the AC adapter. In such a case, keep sufficient distance between the AC adapter and the unit.

NOTE

- If an external power supply that provides current less than 1.5 A is connected, POWER SAVE MODE will be activated automatically, restricting some functions. ("Power saving (energy conservation) mode" on page 74)
- When an external power supply is connected, power from it will be used even if batteries are also installed.

Using USB bus power

Use the supplied USB cable to connect the unit and the computer as illustrated below.

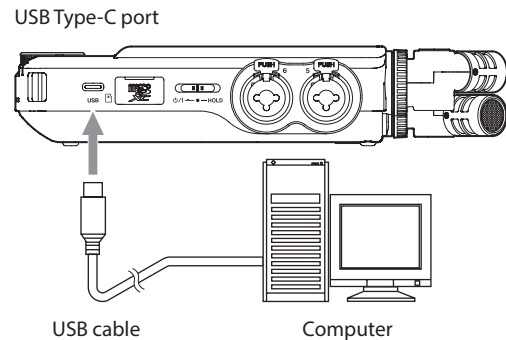

NOTE

- If a computer is going to be used only to supply power, a driver does not need to be installed.
- We recommend connecting it to a USB Type-C port on a computer or other device.
- If the unit is connected to a USB 2.0/3.0/3.1 port, the power supplied will be insufficient, and POWER SAVE MODE will be activated automatically, restricting some functions. ("Power saving (energy conservation) mode" on page 74)

3 - Preparation

3-3 Turning the power on and off

CAUTION

Turn down the volume of the sound system connected to the unit before starting up or shutting down the unit.

Do not wear connected headphones when turning the unit on and off. Noise could damage the headphone driver unit or harm your hearing.

Turning the power on

Slide the ϕ /I/HOLD switch toward ϕ /I until the display is activated. Then, release the switch.

When the unit starts up, the touchscreen display becomes active.



Start up screen

The first time the unit is started, the LANGUAGE screen will open. From the second time, the HOME screen of the app selected on the LAUNCHER screen when the unit was last turned off will reopen.

Turning the unit off (putting it in standby)

Slide the ϕ /I/HOLD switch toward ϕ /I until the display turns off. Then, release the switch.

The unit turns off after it completes its shutdown process.

CAUTION

Always use the ϕ /I/HOLD switch to turn the unit off.

If the unit is not able to conduct shutdown procedures properly, recording data, settings and other changes could be lost. Lost data and settings cannot be restored.

NOTE

The unit cannot be turned off when it is recording or in recording standby.

Resume function

When this unit is turned off, it remembers the position where it was stopped.

The next time it is turned on, playback can be started from where it was stopped.

NOTE

Since the stopped position is saved on the microSD card, it will not be saved if the microSD card is replaced while the power is on.

Setting the language, date and time

Selecting the language

The first time the unit is turned on after purchase, the LANGUAGE screen will open.

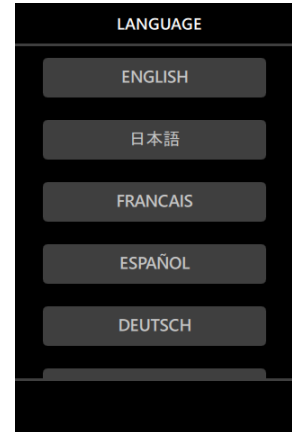

1. Swipe the screen vertically to find the desired language.

Options

ENGLISH:	Use English (default setting)
日本語:	Use Japanese
FRANCAIS:	Use French
ESPAÑOL:	Use Spanish
DEUTSCH:	Use German
ITALIANO:	Use Italian
中文:	Use Chinese
한글:	Use Korean
русский язык:	Use Russian

2. Tap the desired language to set it.

NOTE

The language setting can be set again using the GENERAL SETTINGS screen > SYSTEM page > LANGUAGE item.

Setting the date and time

After setting the language and whenever the date and time has been reset, the DATE/TIME screen will open to enable setting them.

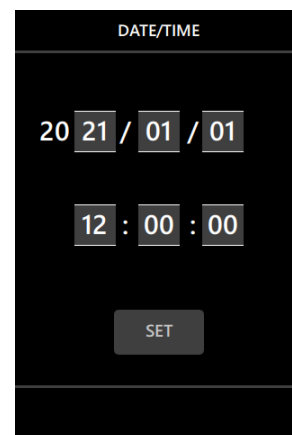

1. Tap and slide the numbers to set the date and time.
2. Tap the SET button to confirm the settings.

NOTE

- After the date and time are set, the format confirmation screen will open if a microSD card that requires formatting is loaded.

- Date and time settings can also be changed using the GENERAL SETTINGS screen > SYSTEM page > DATE/TIME item.

Formatting (initializing) microSD cards

The following message will appear if an unformatted card is loaded. Tap QUICK FORMAT or ERASE FORMAT to start formatting.

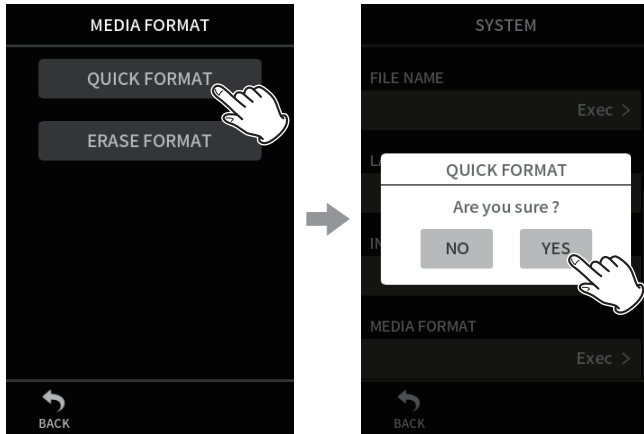

Tap QUICK FORMAT or ERASE FORMAT

Tap YES

- We recommend using ERASE FORMAT when formatting microSD cards the first time they are used with this unit.
- After formatting completes successfully, the LAUNCHER (app selection) screen will open.

CAUTION

Formatting will erase all data on a microSD card.
Back up to a computer, for example before formatting a card.

NOTE

- Formatting can also be executed using the GENERAL SETTINGS screen > SYSTEM page > MEDIA FORMAT item. (page 11)
- Using the ERASE FORMAT option might improve writing performance that has decreased due to repeated use. If "Write error. Recording will continue." or "Card speed reduced. Check BOF mark." appears during recording, format the card using the ERASE FORMAT option.
- ERASE FORMAT checks the memory for errors while formatting, so it takes more time than QUICK FORMAT.

4- Connections

4-1 Connection examples

Using the MANUAL app

Multitrack recording of up to six inputs is possible.

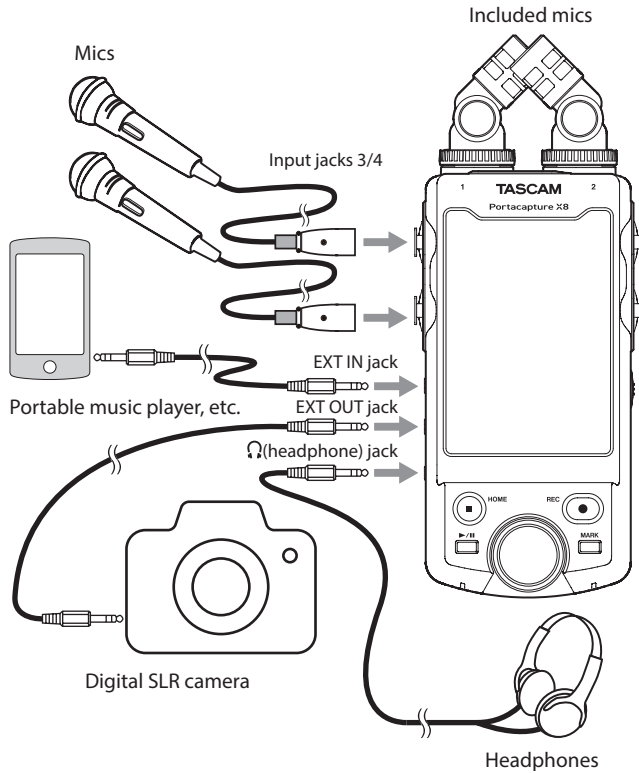

Using the PODCAST app

Multitrack recording of up to four inputs is possible.

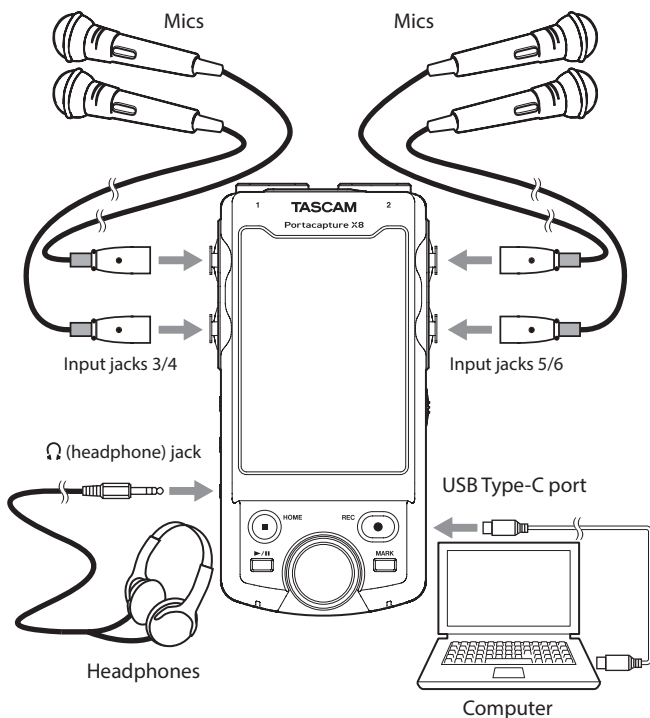

NOTE

To use multiple headphones, use a commercially-available multi-channel headphone amp, for example.

4-2 Connecting the included mics

The included mics can be connected in two ways.

CAUTION

- The included mics become usable by turning their lock rings completely until they are tight.
- The included mics will not be recognized if their lock rings have not been turned completely.
- Always use the included mics together as a pair.

NOTE

- Reverse these procedures to disconnect the mics.
- The angles of the included mics cannot be adjusted.
- The included mics cannot be rotated.
- When the included mics are connected to input jacks 1/2, the track names will become "MIC". When any other plug-in power mics are connected, the track names will become "1" and "2".
- Input jacks 1/2 support plug-in power and can be used to connect lavalier mics with mini 3.5mm (1/8") TRS plugs (Tip: HOT, Ring: COLD, Sleeve: GND).

X-Y connection

This enables recording with a clear stereo field and reduced phase difference.

1. Connect the mics so that their metallic discs face the same direction as the touchscreen.

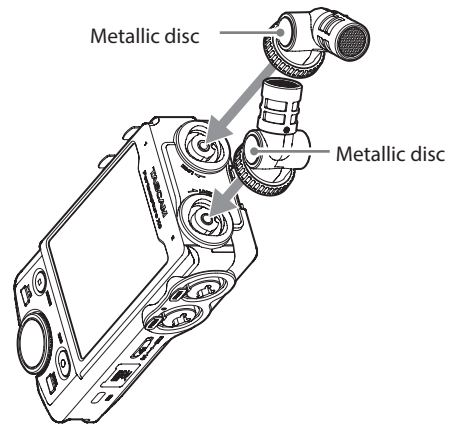

2. Turn their locking rings to fix them in place.

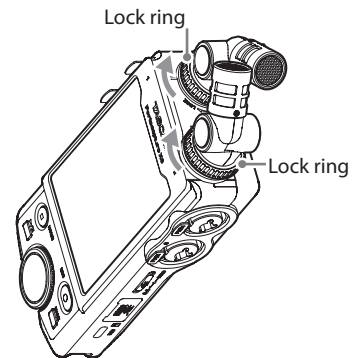

A-B stereo connection

This enables recording with a wide left–right stereo field.

1. Connect the mics so that their metallic discs face the same direction as the touchscreen.

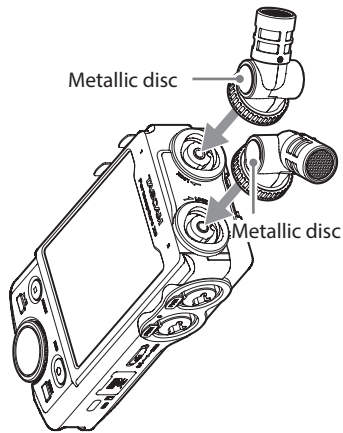

2. Turn their locking rings to fix them in place.

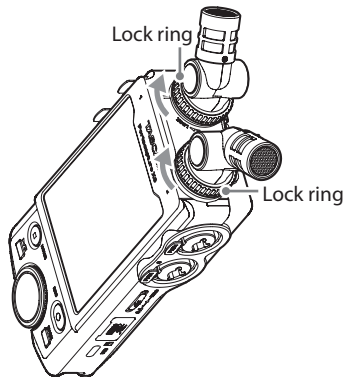

4-3 Connecting external mics and other equipment

Connecting external mics

Connect mics to the XLR or TRS connectors of input jacks 3–6.

Point the mics at the sound source and place the unit in a stable location where there is little vibration.

When connecting to the XLR jacks, insert the plug until a clicking sound is made. When disconnecting, pull the plug out while pressing the locking mechanism.

Example connecting to input jacks 3–4

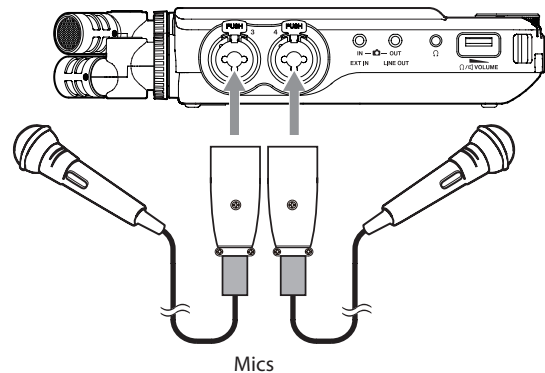

After connecting and making INPUT SELECT settings, use the INPUT settings to select MIC or LINE level. (“Making input settings for each input” on page 27)

NOTE

- Make phantom power settings when using a microphone that requires phantom power. (see “Using phantom power (PHANTOM)” on page 27)
- When connecting a device with unbalanced output, use the EXT IN jack.

Connecting mics that are compatible with plug-in power

In addition to the included mics, other mics that are compatible with plug-in power (3.5mm TRS) can be connected to input jacks 1–2.

Connecting mid-side mics

Mid-side mics can be connected to one input jack pair (3–4 or 5–6). Connect the mid-side mic mid to input jack 3 or 5 and the side to input jack 4 or 6.

After connecting them, select the tracks assigned to the jacks they are connected to using the GENERAL SETTINGS screen > I/O SETTINGS > MS DECODE > SOURCE item.

See “Mid-side decoding function” on page 70 for details about recording with mid-side mics.

4 - Connections

Connecting other equipment

Use the EXT IN jack to connect stereo mini cables.

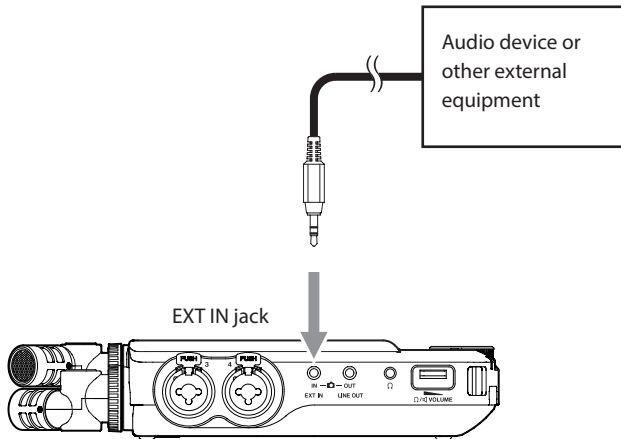

After connecting and making the INPUT SELECT setting (page 26), change the input setting to EXT IN. ("Making input settings for each input" on page 27)

Use input jacks 3-6 to connect XLR and standard TRS plugs.

Example connecting to input jacks 3-4

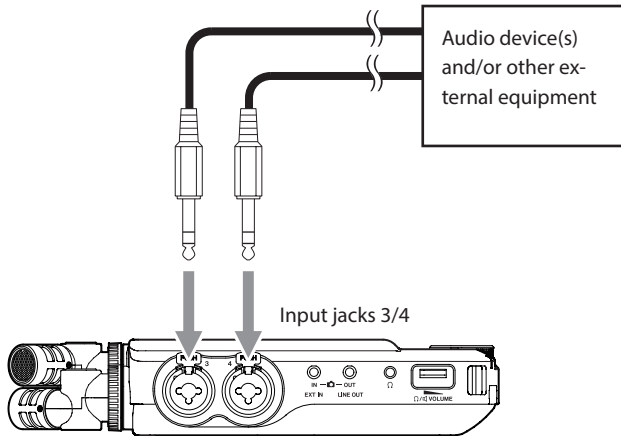

6.3mm (1/4") standard TRS jacks (Tip: HOT, Ring: COLD, Sleeve: GND)

Example connecting to input jacks 3-4

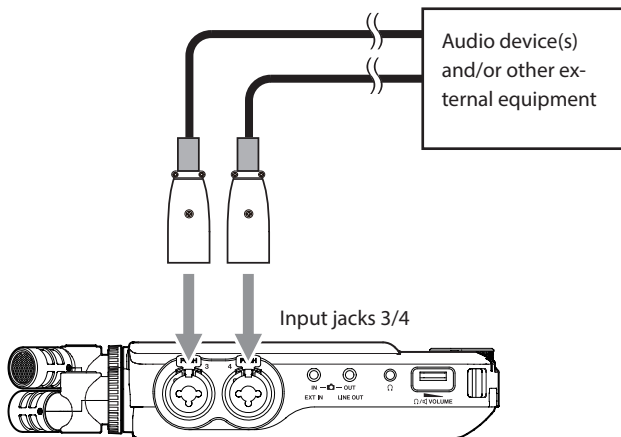

XLR-3-31 equivalent(1: GND, 2: HOT, 3: COLD)

After connecting and making the INPUT SELECT setting (page 26), change the input setting to LINE. ("Making input settings for each input" on page 27)

4-4 Connecting cameras

When recording video with a camera, the same sound can be recorded simultaneously by the camera and this unit. In order to input sound to the camera, connect it with this device as shown below.

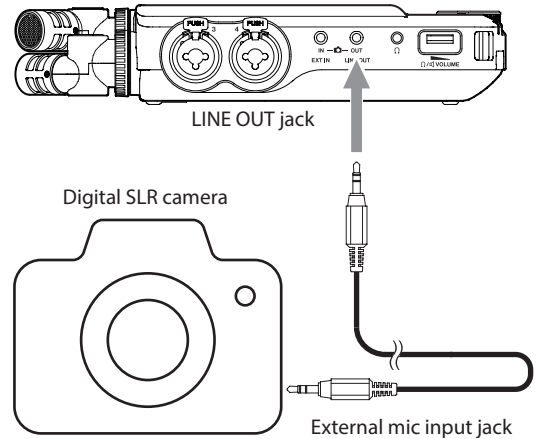

Setting the output for camera use

The line output level can be attenuated up to 30 dB for camera use. See "Setting the output for camera use" on page 65.

4-5 Connecting monitoring equipment

To listen with an external monitoring system (powered monitor speakers or an amplifier and speakers), connect it to the LINE OUT jack.

To listen with headphones, connect them to the Ω (headphone) jack.

Depending on the settings, monitoring might not be possible until the REC [●] button is pushed. See "Recording operation flow" on page 31 for details.

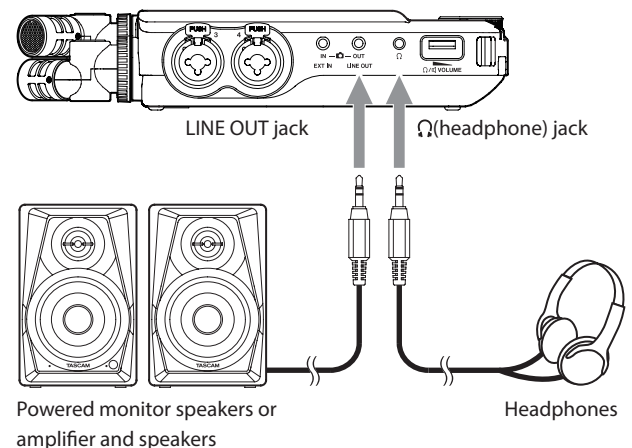

4-6 Using the built-in speaker

To listen to the playback sound through the built-in speaker, set the GENERAL SETTINGS > I/O SETTINGS > SPEAKER item to ON.

NOTE

If anything is connected to either the LINE OUT jack or the Ω (headphone) jack or both, sound will not be output from the speaker even if SPEAKER is set to ON.

4-7 Adjusting the playback volume

Use the Ω / \square (headphone/speaker) volume control to adjust the volume output from the built-in speaker and Ω (headphone) jack.

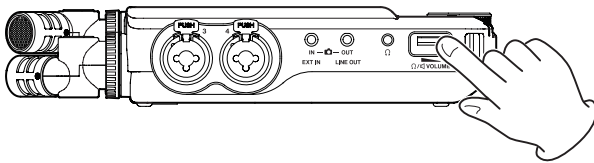

NOTE

- To listen to the playback sound through the built-in speaker, set the GENERAL SETTINGS screen > I/O SETTINGS page > SPEAKER item to on. This is off when shipped new from the factory.
- Sound will not be output through the speaker when the unit is recording, in recording standby, in recording guide mode or when headphones are connected.
- Setting Ω / \square (headphone/speaker) volume to 0 will mute the sound.

4-8 Connecting computers and smartphones

The following functions can be used when connected by USB to a computer (Windows/Mac) or smartphone.

- Use the unit as a USB mic
- Simultaneously record to a computer while recording on the microSD card in the unit (backup recording)
- Monitor sound from the computer
- Use as a microSD card reader (only when connected to a computer)

NOTE

A USB cable must be prepared to connect this unit to a computer (Windows/Mac) or smartphone.(see "USB cables (for communication or data transmission)" on page 7)

USB Type-C port

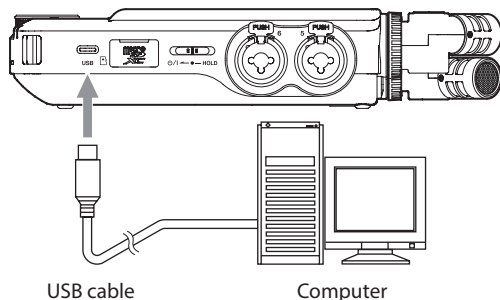

- Stream live mixes of sounds playing back from a computer and input through mics connected to this unit (loopback function)

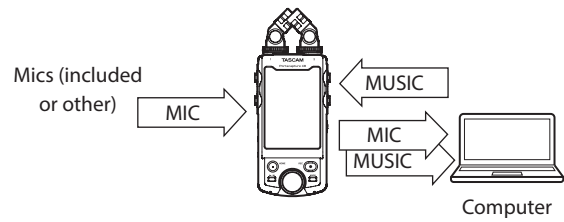

See "USB connection" on page 66 for details about use.

5- Input and output settings

5-1 Using the INPUT SELECT function

Track numbers and input jacks can be assigned in pairs. The INPUT SELECT function can be used from recording app screens.

1. Tap the Shortcut Menu button.

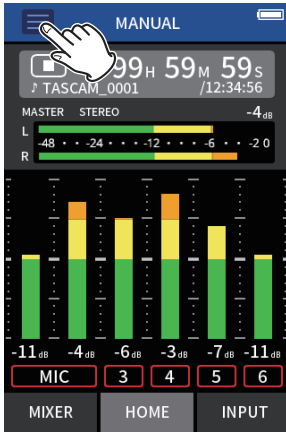

MANUAL recording app example

2. Tap the INPUT SELECT icon in the Shortcut Menu.

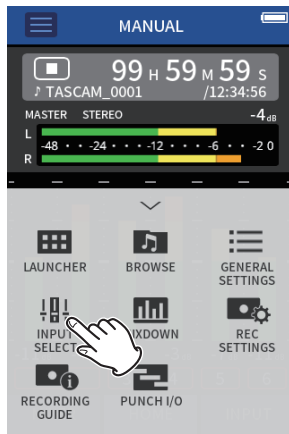

3. Tap a pair of tracks to change their input connector assignments.

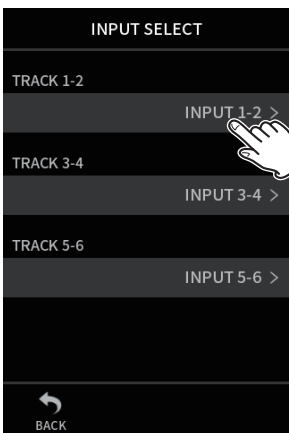

4. Tap the input connector(s) to assign. Repeat steps 3–4 as necessary.

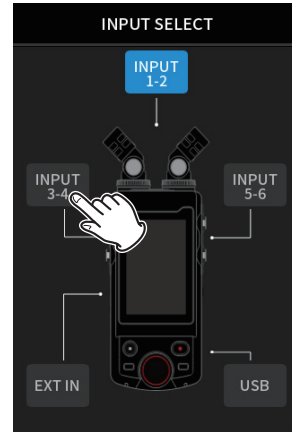

5. Tap the BACK icon to complete the setting.

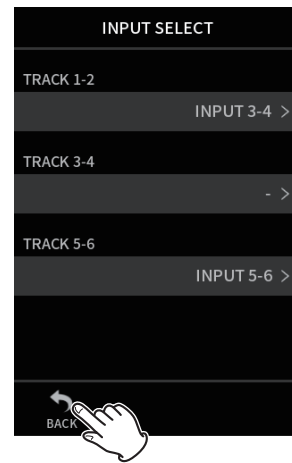

NOTE

- Since INPUT 5-6 and EXT-IN cannot be used at the same time, only one can be assigned to tracks.
- Input settings are retained by newly assigned tracks. The stereo link function is an exception.
- “MIC” will be shown for tracks that have included mics assigned to them.
- “EXT” will be shown for tracks that have the EXT IN jack assigned to them.

5-2 Making input settings for each input

Tap the input settings icon of the track to set or INPUT SETTINGS in the shortcut menu to open the settings screen.

MANUAL recording app example

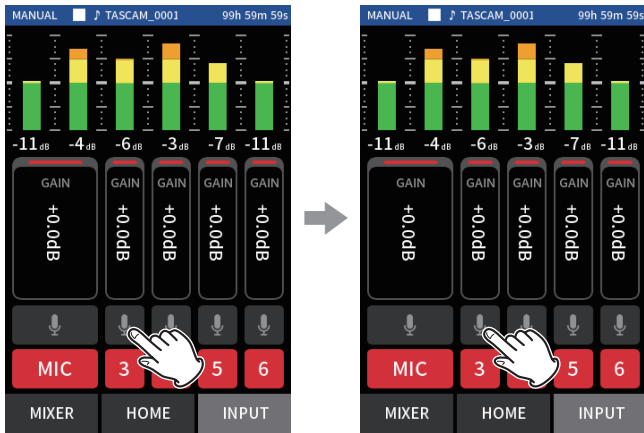

Tap the input settings icon.

NOTE

- Input settings cannot be made for USB.
- Not all setting items are shown on a single screen. Swipe the screen up and down to show the necessary setting items.
- The tracks that can be set depend on the app. (page 13)
- Even though tracks are selected to make settings, they are saved as settings for the input jacks assigned to those tracks. For this reason, when the INPUT SELECT function is used to change the track assignments of input jacks, the settings do not change for those inputs. The stereo link function is an exception.

Using the STEREO LINK function

Audio from track pairs 1–2, 3–4 and 5–6 can be sent to the mixer as stereo.

Select one of the tracks to be stereo-linked, and turn the STEREO LINK setting on.

NOTE

- When shipped new from the factory, stereo-linking is on for tracks 1–2 to which the included mics are connected. "MIC" is shown when the tracks for the included mics are stereo-linked.
- The EXT input STEREO LINK setting is always on, so its STEREO LINK button is disabled.

Setting recording input sources (INPUT)

Track input sources can be set.

Select "MIC" or "LINE" according to the track source.

- When "LINE" is selected the input signal is attenuated –22 dB.

NOTE

- This setting cannot be made for tracks assigned to input jacks 1/2.
- EXT is added as an option for tracks assigned to input jacks 5/6. If EXT is selected, the EXT IN jack will be assigned with stereo-linking to tracks.

Using phantom power (PHANTOM)

Phantom power can be set when a mic that requires it is being used.

NOTE

This can be set when the INPUT setting is MIC.

1. The phantom power voltage can be set according to the connected mic. See "Setting the phantom power voltage" on page 29 for setting procedures.
2. Connect condenser mics that require phantom power to input jacks 3–6 as necessary.
3. In the INPUT SETTINGS, turn the PHANTOM setting on for input jacks with condenser mics that require phantom power connected.
4. Check the pop-up message that appears to confirm turning on phantom power, and tap "YES". Phantom power will be provided to the selected input jacks.
 - When the pop-up message is open, tap "NO" to close the message without enabling phantom power.
 - Even when the PHANTOM setting is on, if the remaining charge of the batteries being used is low, an insufficient battery pop-up message will appear and phantom power will not be supplied.

CAUTION

- Do not connect or disconnect mics with the MIC/LINE IN jacks when phantom power is on. Doing so could cause a loud noise and might damage this unit and connected equipment.
- Turn phantom power on only when using a condenser microphone that requires phantom power. Turning phantom power on when a dynamic mic or other external device that does not require it is connected could damage this unit and the connected equipment.
- When using condenser mics that require phantom power and dynamic mics together, be sure to use balanced dynamic mics. Unbalanced dynamic mics cannot be used when phantom power is enabled.
- Supplying phantom power to some ribbon mics could break them. If you are unsure, do not supply phantom power to a ribbon mic.
- Some condenser microphones will not operate when phantom power is set to +24V.
- Battery operation time will change according to the mics being used. For details, refer to the operation manual of the mic, for example.
- When using phantom power while running on batteries, the operation time might be reduced greatly depending on the mics being used. We recommend using a TASCAM PS-P520U AC adapter (sold separately).

Furthermore, when using an adapter that does not meet the recommended specifications, supplying phantom power to multiple inputs could cause the power to turn off automatically.

- Do not connect or disconnect the AC adapter when using phantom power. The unit could turn off even when batteries are installed, resulting in recorded data becoming damaged or lost.
- When using USB bus power, the unit might not be able to supply phantom power depending on the computer.

Adjusting the input level automatically (AUTO GAIN)

When this function is on, the input level will be adjusted automatically in response to the input audio. Using this function, the recording level is automatically increased when the input sound is too quiet or decreased when it is too loud. This function is useful for recording meetings, for example. When AUTO GAIN is on, the recording level cannot be changed manually.

5 - Input and output settings

Setting the low-cut filter (LOW CUT)

This cuts audio below the selected frequency.

The low-cut filter can reduce bothersome noise, such as from wind, air-conditioners and projectors.

Set the cutoff frequency of the low-cut filter to match the noise.

LOW CUT

OFF(default), 40Hz, 80Hz, 120Hz, 220Hz

NOTE

The LOW CUT function cannot be used when the SAMPLE setting is 192kHz.

Setting the noise gate (NOISE GATE)

Sound below a set level can be muted.

When LOW is selected, only quite sounds will be muted. When HIGH is selected, sounds up to a certain level will also be muted.

NOTE

The NOISE GATE function cannot be used when the SAMPLE setting is 192kHz.

Setting the limiter (LIMITER/COMP)

Using the limiter can suppress distortion caused by sudden excessive sound input.

OFF

The limiter function is disabled.

LIMITER

This function prevents distortion when signals that are too loud are input suddenly.

This is suited for recording live performances and other situations with large volume changes.

NOTE

Distortion could occur when the input sound is excessively loud even if the limiter function is on. In such a case, lower the input level or increase the distance between the unit and the source.

COMPRESSOR

This increases the levels of low-level input signals and adjusts high-level input signals so that they do not become any higher.

This does not have a function to prevent distortion.

This is suited for recording situations that have large volume changes without excessive input levels, for example.

NOTE

The LIMITER and COMPRESSOR functions cannot be used when the SAMPLE setting is 192kHz.

Setting the equalizer (EQ)

The equalizer has the effect of amplifying and attenuating specific frequency ranges. This can be used, for example, to enhance the sound of individual instruments, to adjust the balance of a wide frequency range and to cut specific unwanted frequencies.

VOICE

This setting is good for recording sound in interviews, meetings, podcasts and similar conversational situations.

GUITAR

This setting is good for recording acoustic guitars.

LOUD

The setting is good for emphasizing heavy low frequencies in band performances, for example.

VOCAL

This setting is good for recording singing voices.

MANUAL EQ

With this setting, four bands can be adjusted manually. In addition to low-frequency and high-frequency boosts, two peak curves can be set.

NOTE

The EQ function cannot be used when the SAMPLE setting is 192kHz.

MANUAL EQ

This 4-band parametric EQ can be adjusted manually.



Tap the knob to be adjusted.

Slide the fader left and right to adjust it.

NOTE

After tapping a knob to adjust it, the wheel can be turned to adjust it precisely.

GAIN (LOW/L-MID/H-MID/HIGH) knobs

These set the amounts levels are increased or decreased for each band.

Ranges

GAIN: -12 dB – +12 dB (default: 0 dB)

FREQ (LOW/L-MID/H-MID/HIGH) knobs

These set the cutoff frequencies of the HIGH and LOW bands and the middle frequencies of the H-MID and L-MID bands.

Ranges

HIGH: 1.7 kHz – 18.0 kHz (default 5.5 kHz)

H-MID: 32 Hz – 18.0 kHz (default 1.7 kHz)

L-MID: 32 Hz – 18.0 kHz (default 1.7 kHz)

LOW: 32 Hz – 1.6 kHz (default 400 Hz)

Q (L-MID/H-MID) knobs

These set the acuteness of these bands.

The higher the value is the more acute it becomes, making it affect a narrower frequency band around the set frequency. The lower the value is the less acute it becomes, making it affect a broader frequency band around the set frequency.

Ranges

H-MID: 0.25 – 16.00 (default 2.00)

L-MID: 0.25 – 16.00 (default 2.00)

Examples of EQ characteristics

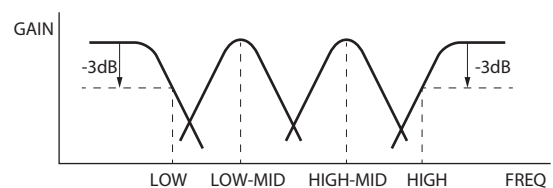

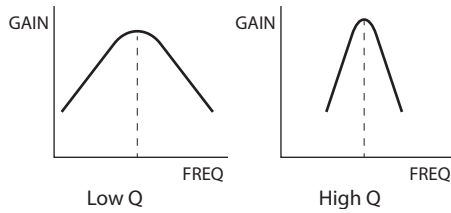

Inverting the input phase (PHASE INVERT)

Turning this on will invert the phase.

NOTE

If the sound seems to be unclear when recording the same source with more than two or more mics, inverting the phase of one or more inputs could improve the sound quality.

Adjusting input gain (GAIN)

Swipe the GAIN fader to adjust the input level.

- While watching the level meter, adjust the GAIN so that the level averages around -12dB and the PEAK indicator does not light.
- The recording sound might distort when the PEAK indicator lights.

NOTE

If the input level exceeds -2 dB , the PEAK indicator on the unit will light.

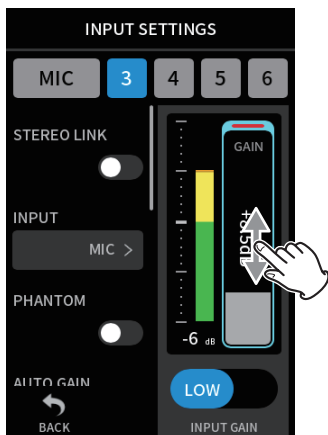

NOTE

After tapping the GAIN, the wheel can be turned to adjust it precisely.

Changing the input gain (GAIN)

The two input gain options are GAIN LOW and GAIN HIGH. Tap the GAIN LOW/GAIN HIGH button to switch to the other option.

NOTE

- Adjust the input gain using the GAIN LOW setting first. If the gain is insufficient, switch to GAIN HIGH and adjust the gain.
- The INPUT GAIN switches of stereo-linked inputs are also linked.
- The INPUT GAIN switches of inputs 1–2 stay linked even when the inputs are not stereo-linked.

5-3 Adding reverb to inputs (REVERB)

Set this with the GENERAL SETTINGS screen > I/O SETTINGS page > REVERB item.

When this is on, reverb will be applied to the selected tracks (1/2, 3/4, 5/6, MIX).

NOTE

Reverb cannot be used when the SAMPLE setting is 96kHz or 192kHz.

TYPE

This sets the type of reverb.

TYPE	Effect
LARGE HALL (default)	This reverb is modeled on a large hall space.
SMALL HALL	This reverb is modeled on a small hall space.
ROOM	This reverb is modeled on a small indoor space.
STUDIO	This reverb is modeled on a studio-like space.
PLATE 1	This emulates a plate reverb with a large plate.
PLATE 2	This emulates a plate reverb with a small plate.

SOURCE

Use this to select the tracks affected by the reverb.

When MIX is selected, reverb is applied to the mixer output.

LEVEL

This sets the reverb level.

5-4 Setting the phantom power voltage

Set the phantom power voltage supplied with the GENERAL SETTINGS screen > I/O SETTINGS page > PHANTOM item.

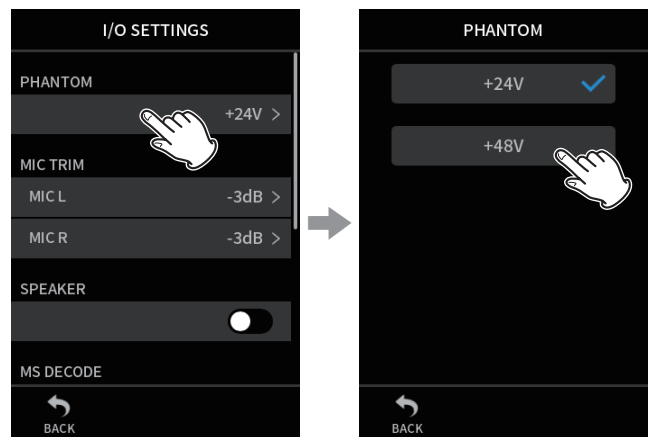

Tap the PHANTOM value.

Tap the desired voltage.

NOTE

- Turn phantom power output on/off on the INPUT screen. (page 27)
- The default value is 48V.
- Battery power will be consumed faster when set to 48V than when set to 24V.

6- Recording apps

6-1 Recording app overview

Recording guide function (MANUAL app only)

To record, open the recording app shown on the LAUNCHER screen that suits the type of recording (see "App overview" on page 11). After launching the recording app, the input levels of each track and their mix must also be set in order to record at suitable levels. This unit has a recording guide function designed to prevent users from accidentally skipping important steps or doing them out of order. This

function can only be used with the MANUAL app. (When shipped new the recording guide is on by default.) After the MANUAL app is launched, operation procedures will be shown. Follow their instructions to make adjustments. When the recording guide is active, setting screens open in the following order, enabling settings to be made in the correct sequence.

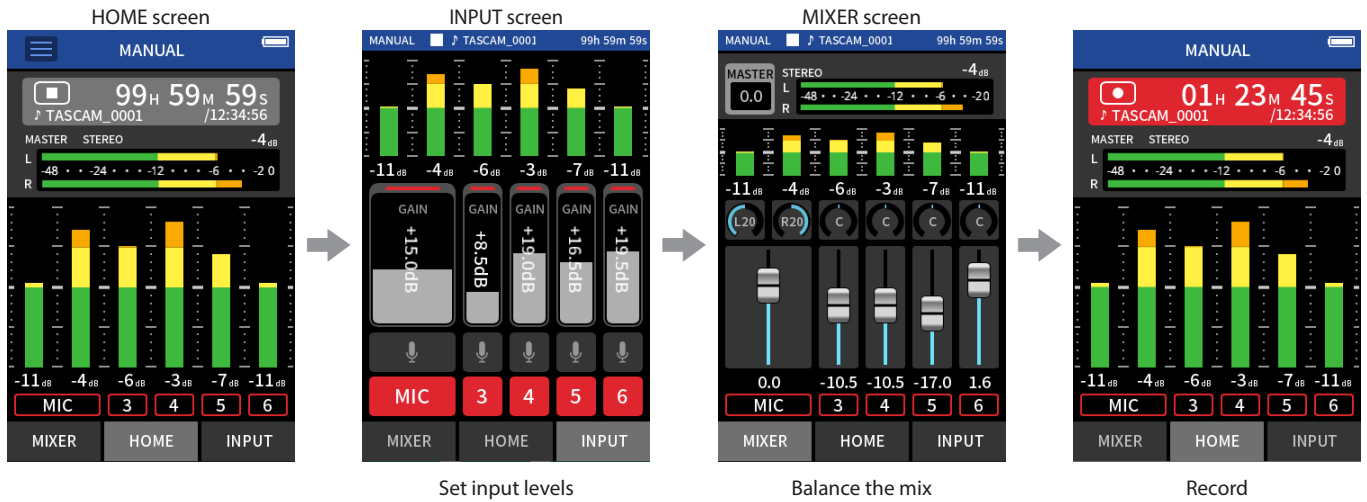

NOTE

No guide related to input and output settings will be shown.

Guide examples

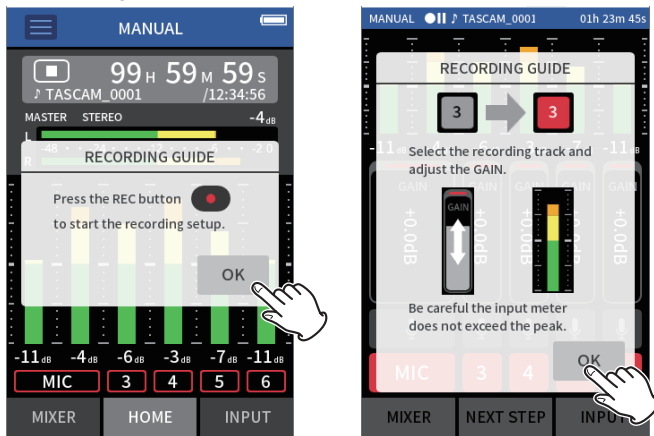

NOTE

- By default (recording guide activated), recording cannot be started before proceeding through the guided steps to the MIXER screen.
- If the recording guide is not needed, open the MANUAL app HOME screen, press the Shortcut Menu, and turn RECORDING GUIDE off. This enables recording to be started from other screens in addition to the MIXER screen.
- See "Recording operation flow" on page 31 for differences in recording operations when the recording guide function is on or off.
- Even when the recording guide is on, recording can be restarted from the MIXER screen and other screens when recording is paused.

Recording pause function

This unit has a recording pause function that causes it to start monitoring the input signal when the REC [●] button is pressed. This function can be used with all recording apps. A recording can be started and paused repeatedly without stopping, allowing it to be saved as a single file. The recording pause function is off when shipped new from the factory. When the recording pause function is off, the input signal is always monitored when a recording app is active. When the recording pause function is on, the input signal is only monitored when the recording guide function is active, recording is paused or recording is in progress. The recording pause function can be set with the GENERAL SETTINGS screen > REC SETTINGS page > REC PAUSE item.

NOTE

When the recording pause function is activated monitoring of input signals is disabled when recording is stopped, reducing power consumption.

Recording operation flow

Depending on the RECORDING GUIDE¹ and REC PAUSE² on/off settings, pressing buttons will have the following effects.

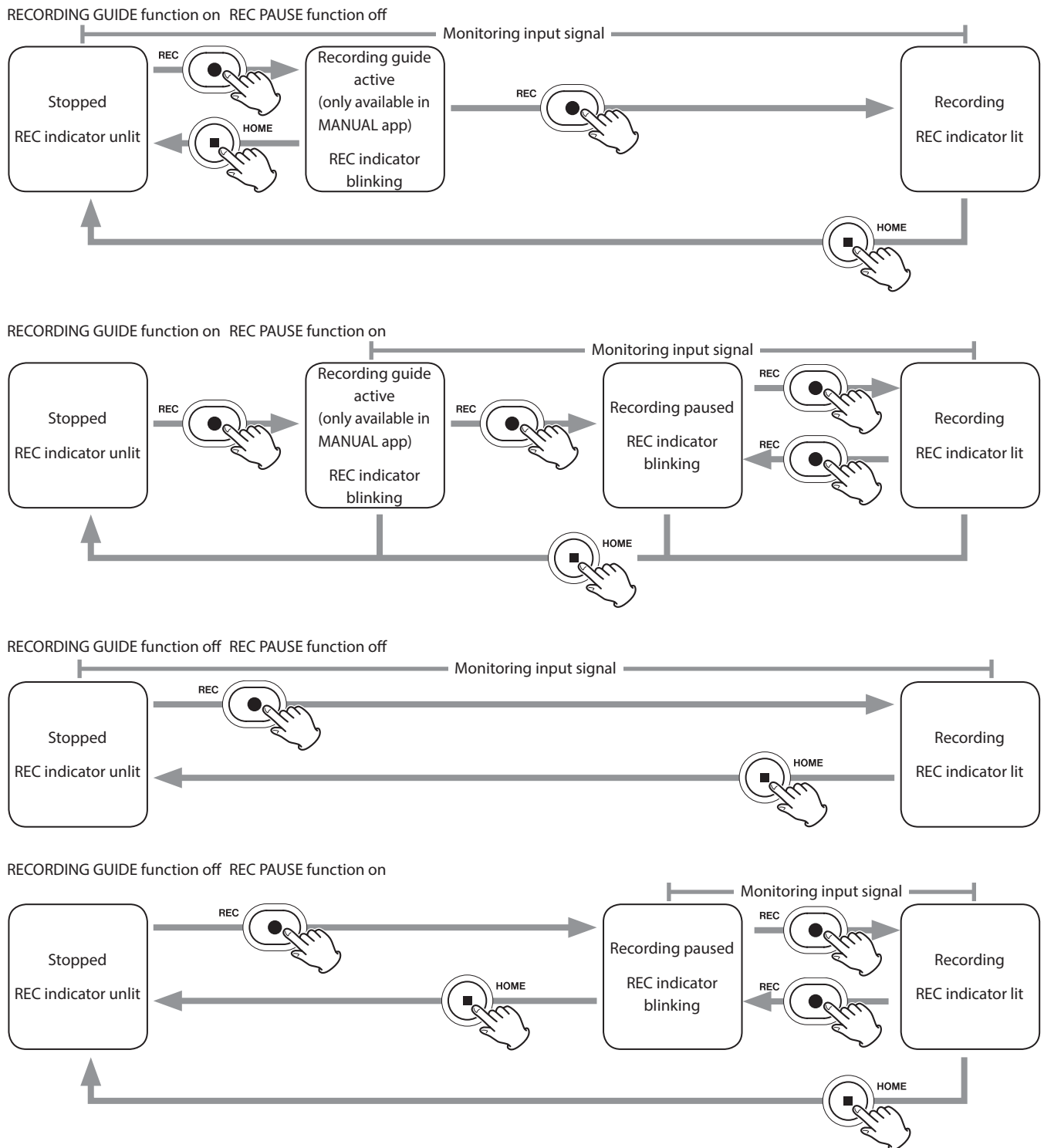

¹ The recording guide function can only be used with the MANUAL app. With apps other than the MANUAL app, the recording guide function will be disabled regardless of its on/off setting.

6 - Recording apps

6-2 Button operations during recording

Recording pause function on

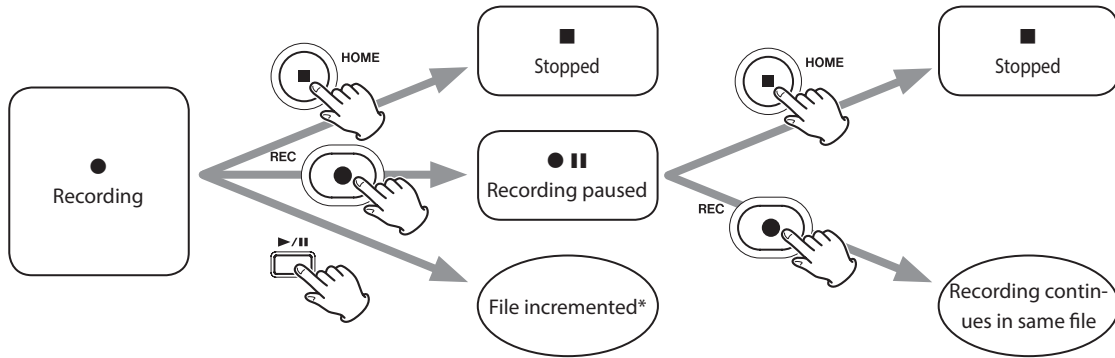

Recording pause function off

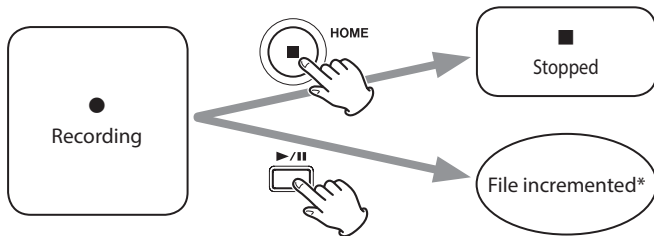

*See "Changing files while continuing to record (TIME FILE INCREMENT function)" on page 49 for information about file incrementation.

6-3 Recording with the ASMR app

The screen effect changes in response to the input sound in this recording app. To emphasize the sense of stereo when using the included mics, we recommend recording using them connected in the A-B format. ("Connecting the included mics" on page 22)

Setting procedures

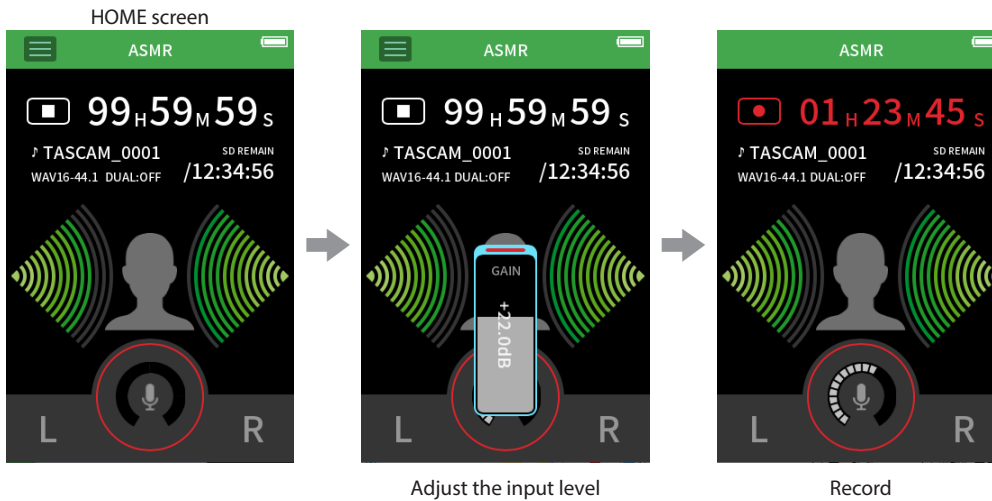

Screen overview

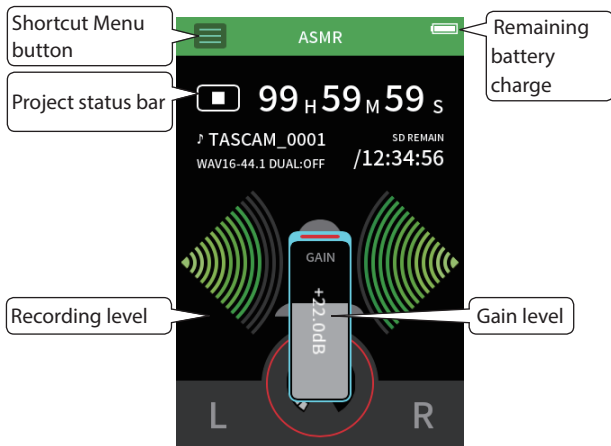

Shortcut Menu

Press the Shortcut Menu button to open the menu shown below.

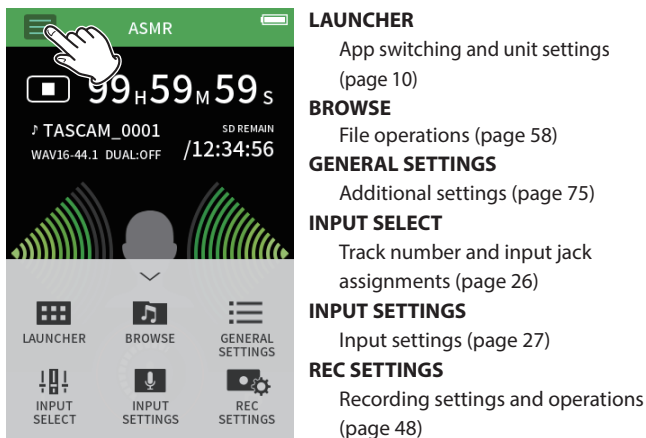

Setting input levels

1. Tap the ring in the center of the screen.
2. Bring the mics closer to the recording subject. While checking the level meters, raise the GAIN as high as possible without causing the PEAK indicator to light.

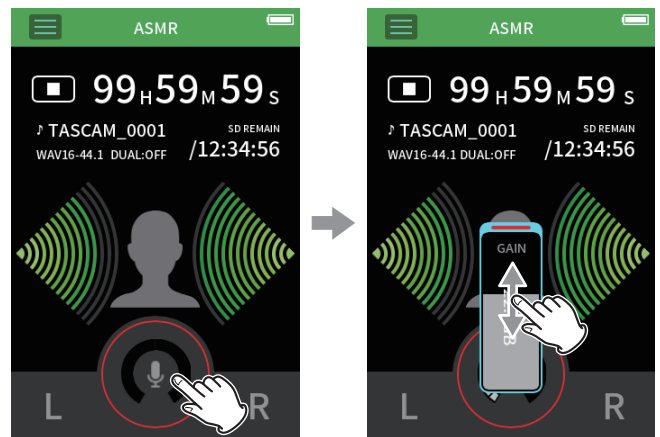

NOTE

- If the input level exceeds -2 dB, the PEAK indicator on the unit will light.
- The recording sound might distort when the PEAK indicator lights.
- After tapping the GAIN, the wheel can be turned to adjust it precisely.

6 - Recording apps

Recording

Press the REC [●] button on the unit to start recording.



NOTE

- When the recording pause function is enabled, press the REC [●] button to pause recording and continue input signal monitoring. Press the REC [●] button again to start recording.
- After tapping the GAIN, the wheel can be turned to adjust it precisely.

Press the HOME [■] button to stop recording.



See “Recording settings” on page 48 for other recording operations.

Starting playback

Press the ►/|| button to play the last recorded master file.



See “Playing files” on page 52 for other playback operations.

6-4 Recording with the MANUAL app

This is the basic app of the unit. Multitrack recording of up to six channels is possible.

Setting procedures

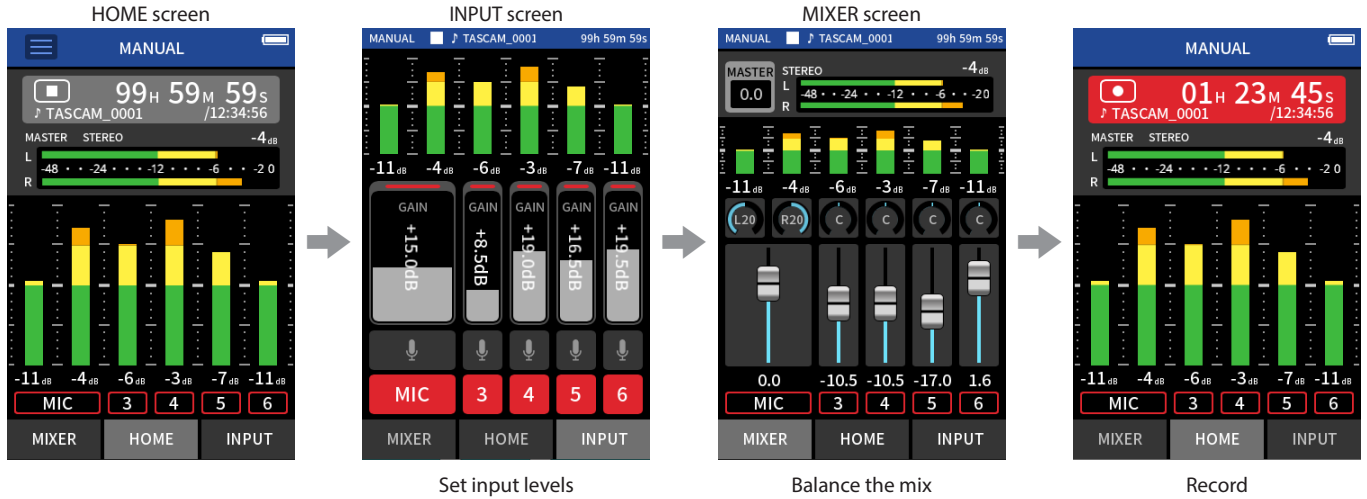

Screen overview

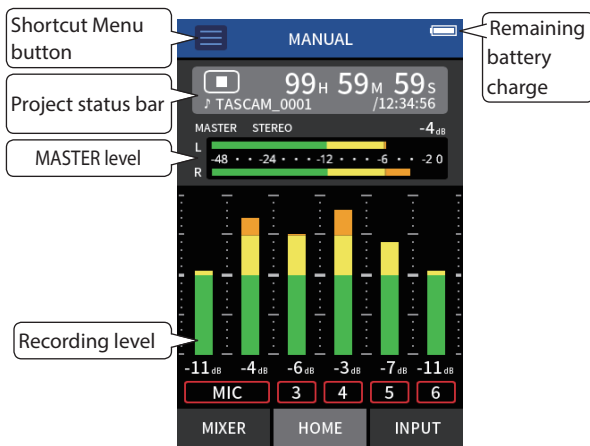

Shortcut Menu

Press the Shortcut Menu button to open the menu shown below.

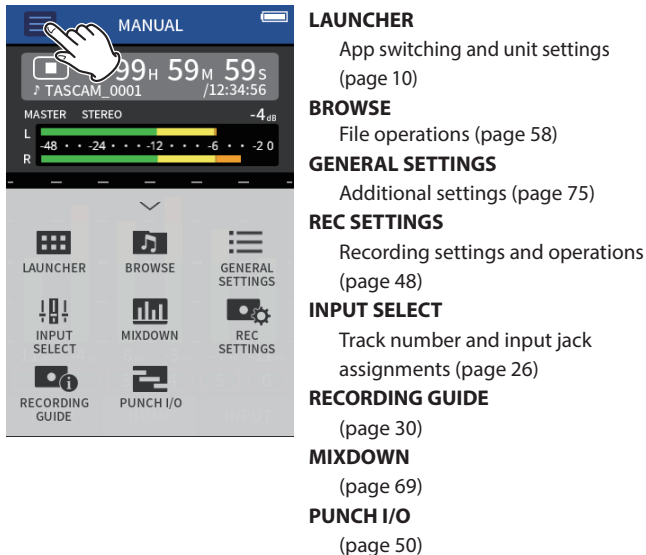

Using the wheel

After tapping a GAIN, fader or pan control or the MASTER level, the wheel can be turned left and right to adjust the setting precisely. This is convenient for precise adjustments after making rough value changes by sliding.

Setting input levels

1. Open the HOME screen, and press the REC [●] button on the unit. The REC indicator will blink and the INPUT screen will open automatically.

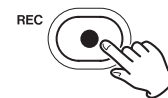

When the recording guide and recording pause functions are both off, there is no need to press the REC [●] button. (page 31)

2. Tap numbers 1 to 6 and MIC to turn their inputs on and off. Tracks shown with red backgrounds will be recorded. When the FILE FORMAT is WAV, tracks that are on will be recorded.

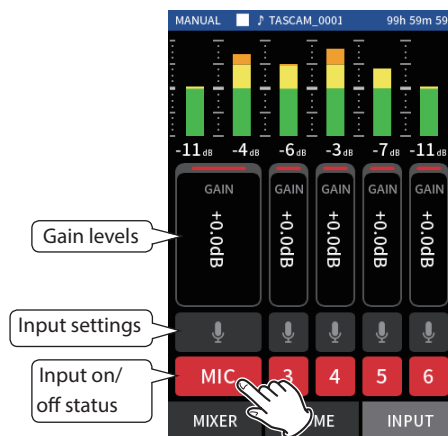

See "Making input settings for each input" on page 27 for details about input settings.

6 - Recording apps

- While watching the level meters, adjust the GAIN so that they average around -12 dB and the PEAK indicators do not light.

NOTE

- If an input level is too low the recorded sound will be quiet, but if it is too high the sound will be distorted (or break up).
- If the input level exceeds -2 dB, the PEAK indicator on the unit will light.
- The recording sound might distort when the PEAK indicator lights.
- After tapping the GAIN, the wheel can be turned to adjust it precisely.

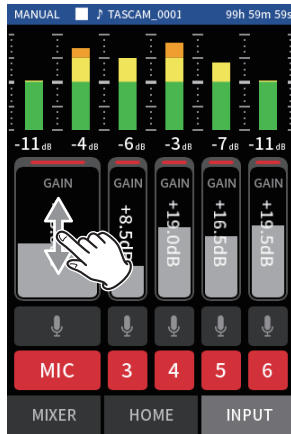

Using the mixer

- Tap MIXER at the bottom of the screen to open the MIXER screen.



- Slide the faders of each track to adjust the balance of levels sent to the MASTER.

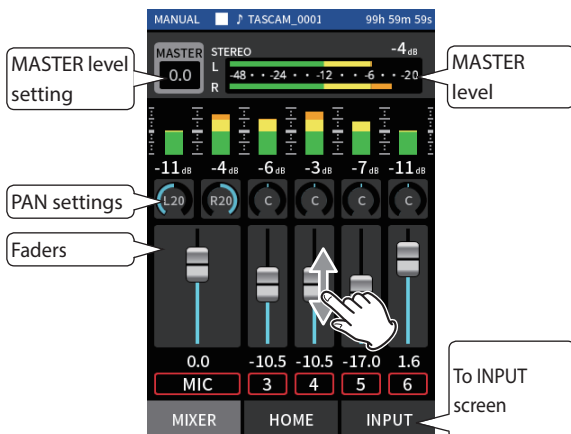

Faders

Use these to adjust the output levels of each track.

Pan settings

Use these to adjust the left-right volume balance.

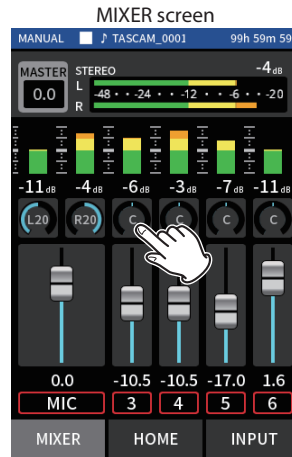

Tap a pan setting

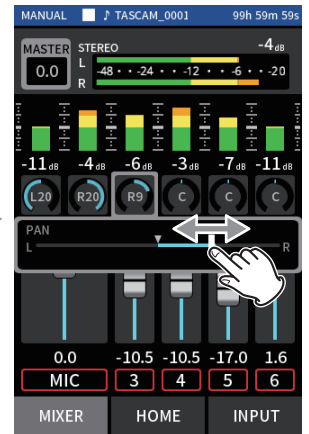

Slide the slider left and right to adjust the balance.

MASTER level setting

Use this to adjust the level of the mix of all tracks.

After adjusting the balance of the individual track levels, use this when you want to adjust the overall level.

Change the setting below the fader to MONO if you want to make the mix of all the tracks mono.



Tap the MASTER level setting



Slide the fader left and right to adjust the level.

NOTE

The unit mix balance settings are saved when the current project is changed and when the unit is turned off. The master file stereo/mono setting, however, is not retained by this unit. Always make this setting when recording.

Recording

1. Press the REC [●] button to start recording.



When recording starts, the REC indicator will light.

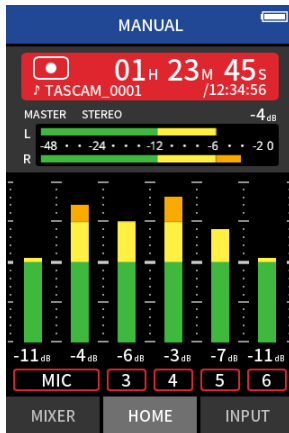

NOTE

Depending on the operation mode settings, recording might not start until the REC [●] button is pushed multiple times. See “Recording guide function (MANUAL app only)” on page 30 for details.

2. Press the REC [●] or HOME [■] button to stop recording.

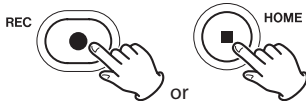

When recording stops, the REC indicator will become unlit and the HOME screen will open automatically.

NOTE

When the REC PAUSE function is off, the REC [●] button is disabled.

See “Recording settings” on page 48 for other recording operations.

Starting playback

Press the ►/|| button to play the last recorded track file.



See “Playing files” on page 52 for other playback operations.

NOTE

- If files were recorded when the current project was using a two-channel recording app, master files will be played.
- If files were recorded when the current project was using the POD-CAST app, sound pad sounds will be assigned to tracks 5–6.

6 - Recording apps

6-5 Recording with the MUSIC app

This recording app is good for easily capturing instrumental and vocal performances.

Setting procedures

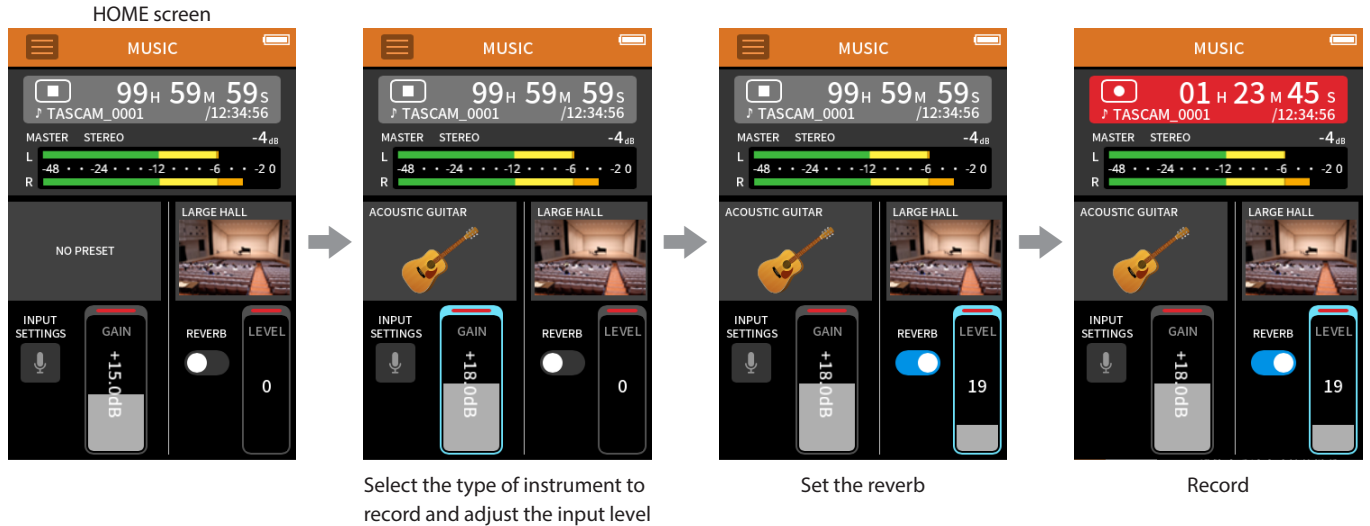

Screen overview

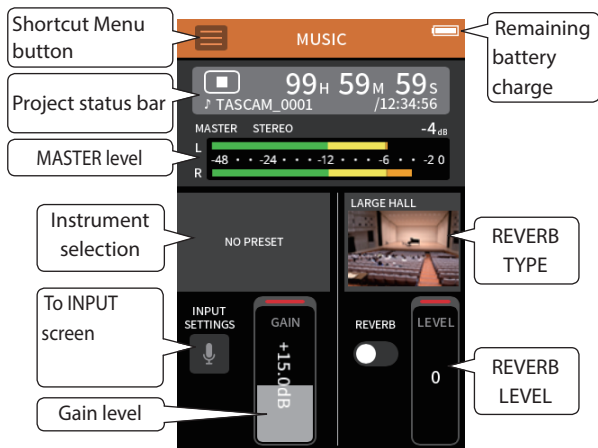

Selecting the type of instrument to record

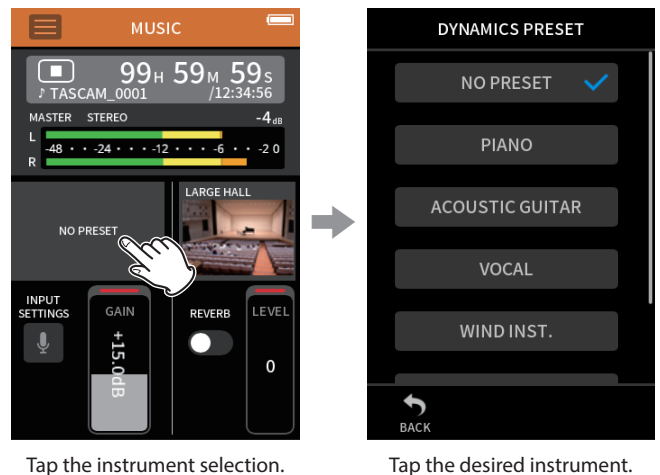

Shortcut Menu

Press the Shortcut Menu button to open the menu shown below.

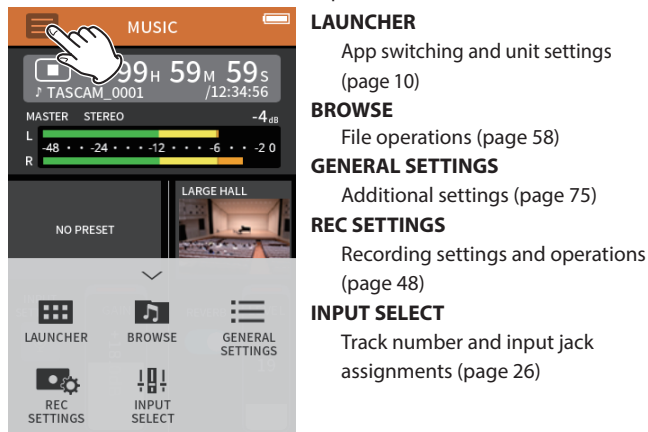

NO PRESET

This unaffected setting does not apply any dynamics preset to the sound.

PIANO

Designed for piano

ACOUSTIC GUITAR

Designed for acoustic guitar

VOCAL

Designed for singing

WIND INST.

Designed for wind instruments

STRINGED INST.

Designed for string instruments

BAND

Designed for band performances

- If none of the options match the desired instrument, select NO PRESET.

Setting the input level



While playing an instrument and watching the level meter, adjust the GAIN so that the level averages around -12 dB and the PEAK indicator does not light.

NOTE

- If the input level exceeds -2 dB, the PEAK indicator on the unit will light.
- The recording sound might distort when the PEAK indicator lights.

- Tap INPUT SETTINGS to adjust settings other than the input level. See “Making input settings for each input” on page 27 for details about settings.
- After tapping the GAIN, the wheel can be turned to adjust it precisely.

See “Making input settings for each input” on page 27 for details about input settings.

Adding reverb to the input (REVERB)

1. Tap the REVERB setting to turn it on.
2. Tap the REVERB TYPE to change the selection.
3. Slide the REVERB LEVEL fader to adjust its level.

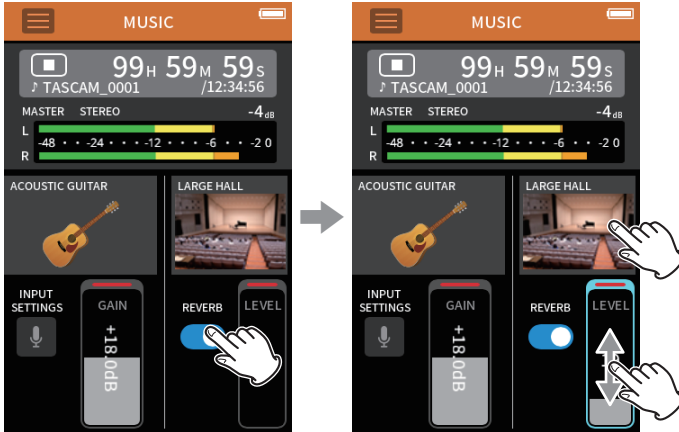

NOTE

After tapping the REVERB, the wheel can be turned to adjust it precisely.

For details, see “Adding reverb to inputs (REVERB)” on page 29.

Recording

Press the REC [●] button on the unit to start recording.

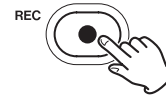

NOTE

When the recording pause function is enabled, press the REC [●] button to pause recording and continue input signal monitoring. Press the REC [●] button again to start recording.

Press the HOME [■] button to stop recording.



See “Recording settings” on page 48 for other recording operations.

Starting playback

Press the ►/|| button to play the last recorded master file.



See “Playing files” on page 52 for other playback operations.

6 - Recording apps

6-6 Recording with the VOICE app

This recording app is good for recording audio for interviews and video blogs.

Setting procedures

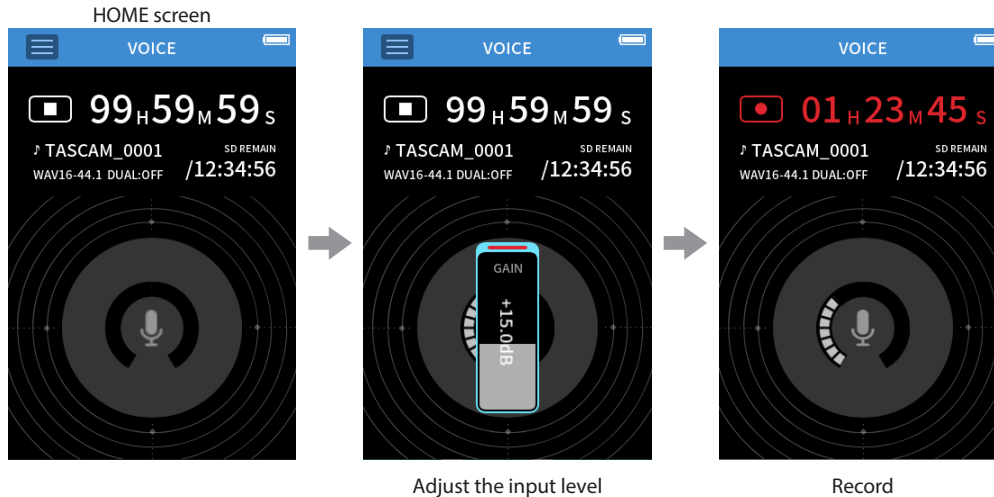

Screen overview

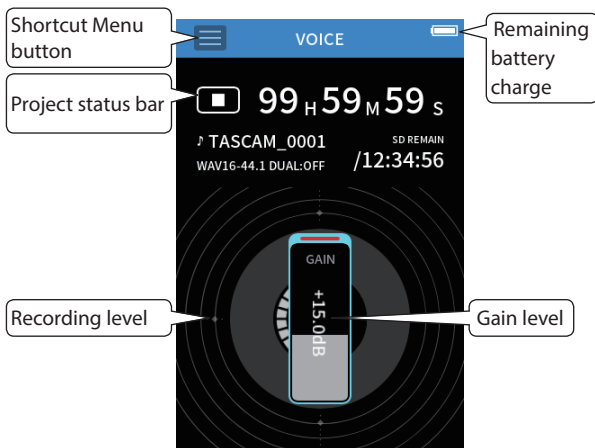

Shortcut Menu

Press the Shortcut Menu button to open the menu shown below.

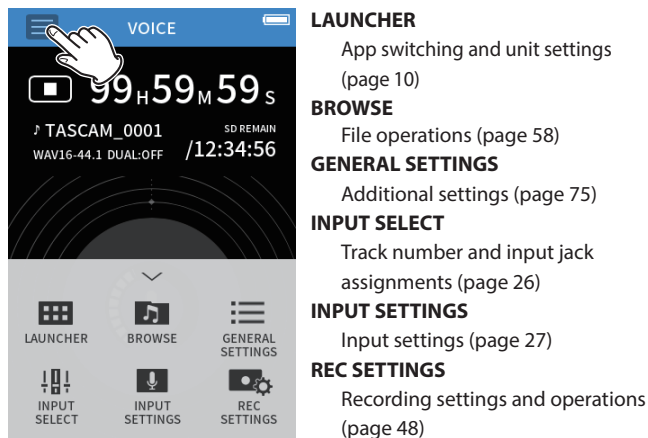

Setting the inputs

For details, see "Making input settings for each input" on page 27.

Setting the input level

1. Tap the ring in the center of the screen.
2. Speak toward the mic and adjust the GAIN so that the recording level display does not become red.

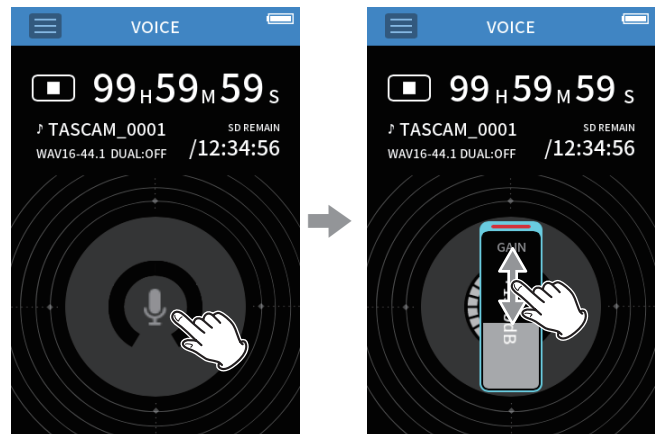

Recording

Press the REC [●] button on the unit to start recording.



NOTE

When the recording pause function is enabled, press the REC [●] button to pause recording and continue input signal monitoring. Press the REC [●] button again to start recording.

Press the HOME [■] button to stop recording.



See “Recording settings” on page 48 for other recording operations.

Starting playback

Press the ►/|| button to play the last recorded master file.



See “Playing files” on page 52 for other playback operations.

6 - Recording apps

6-7 Recording with the FIELD app

This app is good for recording outdoors.

Setting procedures

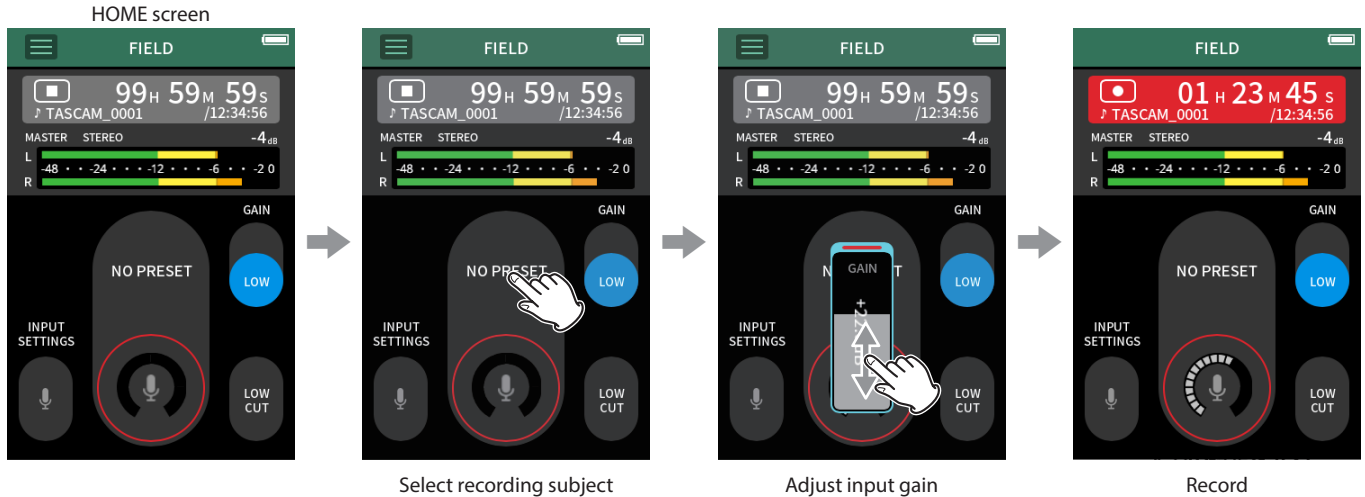

Screen overview

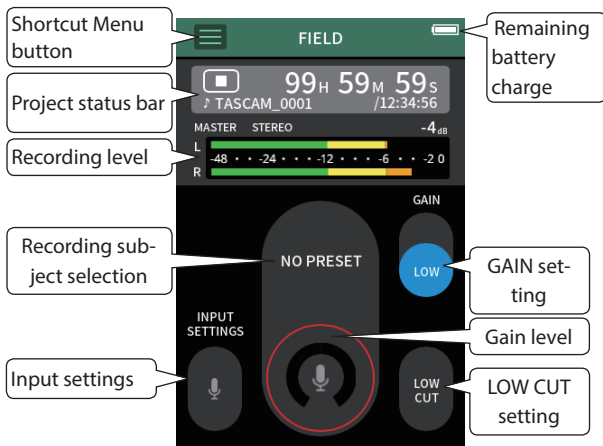

Shortcut Menu

Press the Shortcut Menu button to open the menu shown below.

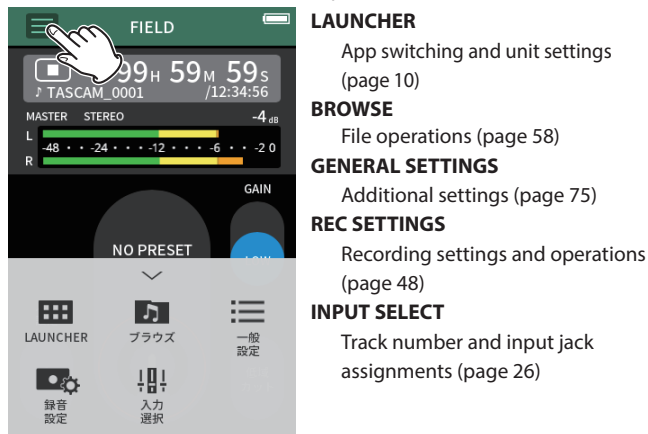

Setting the inputs

For details, see "Making input settings for each input" on page 27.

Selecting the recording subject

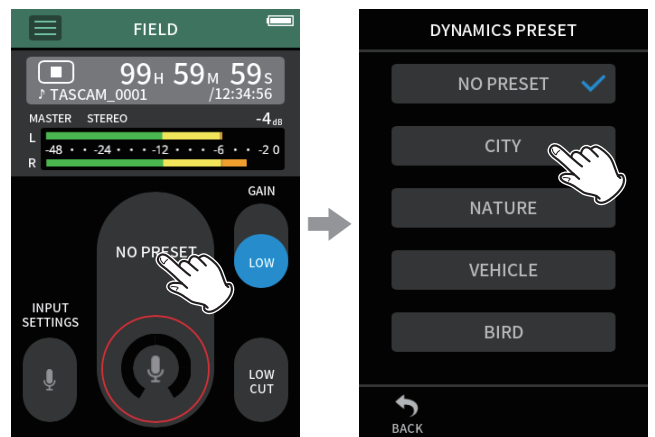

NO PRESET

Use mic preamps as is (no processing)

CITY

Crowds and other urban sounds

NATURE

Rustling leaves, murmuring streams and other natural sounds

VEHICLE

Trains, motorsports, etc.

BIRD

Wild bird calls and similar sounds

- If none of the options match the desired subject, select NO PRESET.

Setting the input level

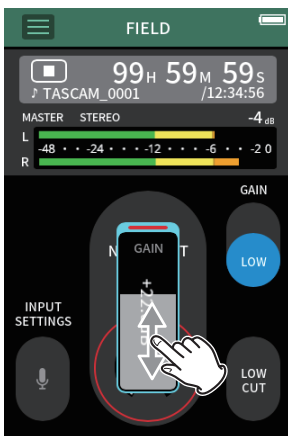

While pointing the mic at the recording subject and watching the level meter, adjust the GAIN so that the level averages around -12 dB and the PEAK indicator does not light.

NOTE

- If the input level exceeds -2 dB, the PEAK indicator on the unit will light.
- The recording sound might distort when the PEAK indicator lights.

- After tapping the GAIN, the wheel can be turned to adjust it precisely.

Tap INPUT SETTINGS to adjust settings other than the input level. See “Making input settings for each input” on page 27 for details about settings.

Changing the gain (GAIN)

Adjust the input gain using the LOW setting first. If the gain is insufficient, switch to HIGH and adjust the gain.

Setting the filter (LOW CUT)

The low-cut filter can reduce bothersome noise, such as from wind, air-conditioners and projectors.

Set the cutoff frequency of the low-cut filter to match the noise.

Recording

Press the REC [●] button on the unit to start recording.



NOTE

When the recording pause function is enabled, press the REC [●] button to pause recording and continue input signal monitoring. Press the REC [●] button again to start recording.

Press the HOME [■] button to stop recording.



See “Recording settings” on page 48 for other recording operations.

Starting playback

Press the ►/|| button to play the last recorded master file.



See “Playing files” on page 52 for other playback operations.

6 - Recording apps

6-8 Recording with the PODCAST app

This app is good for recording podcasts with up to four people.

Setting procedures

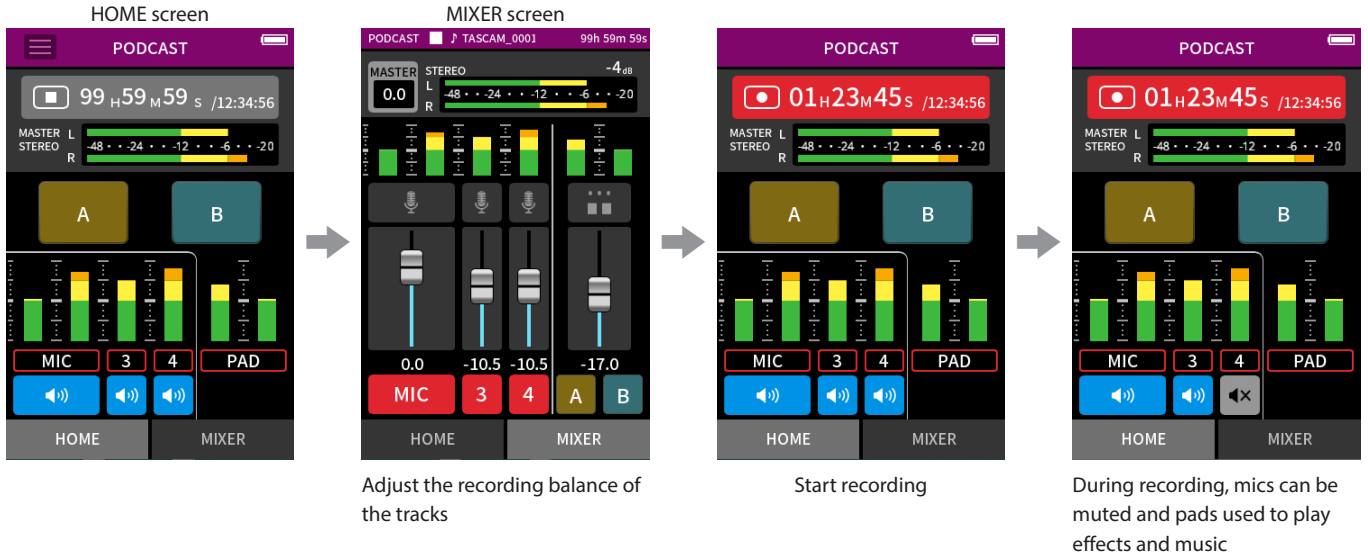

Screen overview

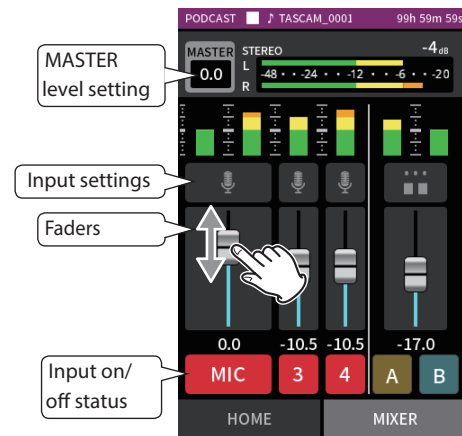
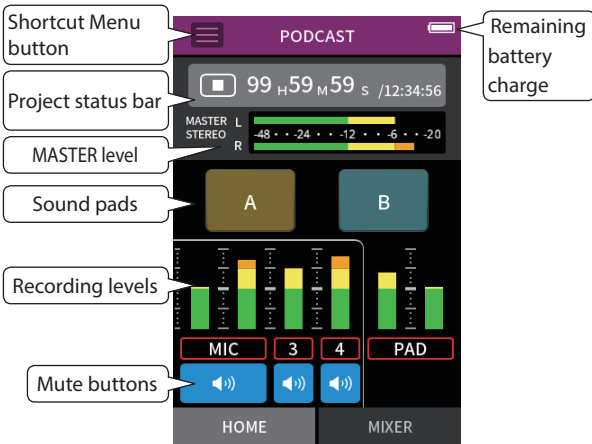

Shortcut Menu

Press the Shortcut Menu button to open the menu shown below.

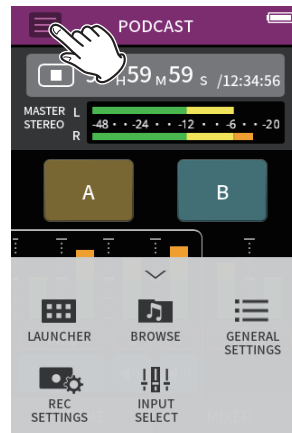

LAUNCHER

App switching and unit settings (page 10)

BROWSE

File operations (page 58)

GENERAL SETTINGS

Additional settings (page 75)

REC SETTINGS

Recording settings and operations (page 48)

INPUT SELECT

Track number and input jack assignments (page 26)

Using the wheel

After tapping a GAIN, fader or pan control or the MASTER level, the wheel can be turned left and right to adjust the setting precisely.

This is convenient for precise adjustments after making rough value changes by sliding.

Setting input levels

1. Open the MIXER screen.
2. Tap the input settings icon.
3. While inputting the voice and watching the level meters, adjust the GAIN so that they average around -12 dB and the PEAK indicators do not light.

NOTE

- If the input level exceeds -2 dB, the PEAK indicator on the unit will light.
- The recording sound might distort when the PEAK indicator lights.

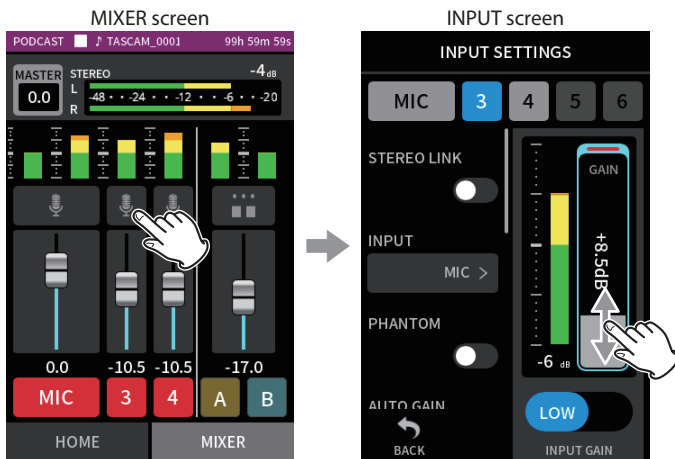

Tap the input settings icon.

Slide the GAIN fader to adjust the input level.

Using the mixer

Slide the faders to adjust the mix balance.

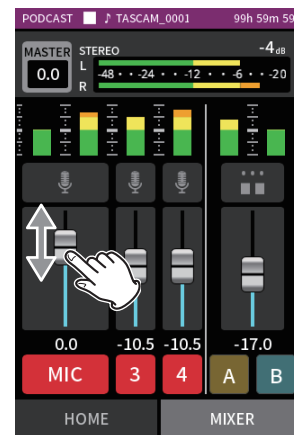

MASTER level setting

Use this to adjust the level of the mix of all tracks. After adjusting the balance of the individual track levels, use this when you want to adjust the overall level. Change the setting below the slider to MONO if you want to make the mix of all the tracks mono.

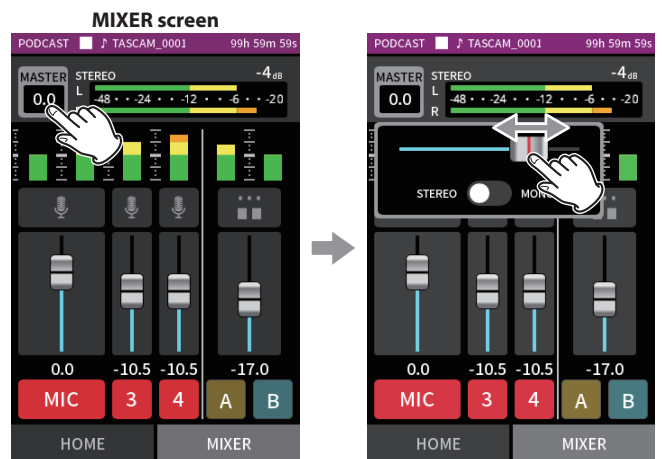

Tap the MASTER level setting

Slide the fader left and right to adjust the level.

Recording

Press the REC [●] button on the unit to start recording.

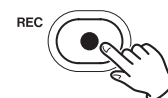

NOTE

When the recording pause function is enabled, press the REC [●] button to pause recording and continue input signal monitoring. Press the REC [●] button again to start recording.

Press the HOME [■] button to stop recording.



See "Recording settings" on page 48 for other recording operations.

6 - Recording apps

Making sound pad settings

Sounds can be assigned to the sound pads and how they play when the buttons are pushed can be set.

Selecting the button to set



Tap the pad settings on the right side.

Tap the sound pad to set.

Setting the playback sound

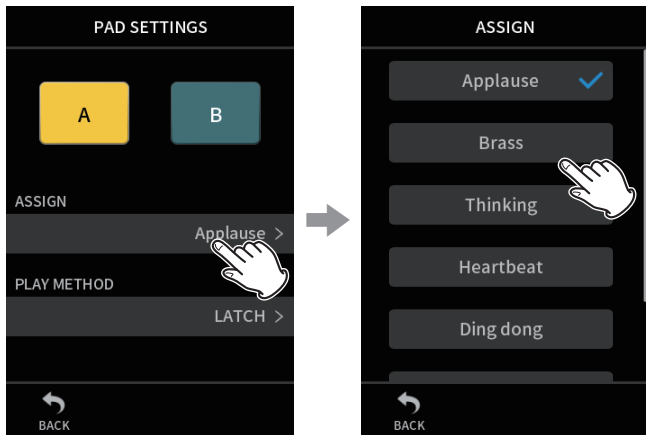

Tap ASSIGN.

Tap the desired setting.

Applause

This plays sounds of clapping and cheering. This is assigned to yellow pads by default.

Brass

This plays a horn crescendo. This is assigned to green pads by default.

Thinking

This plays a short acoustic bass phrase.

Heartbeat

This plays the sound of a heart beating.

Ding dong

This plays a door chime twice.

Wrong answer

This plays a buzzer twice.

SD CARD

microSD cards that have been formatted by this unit have a SOUND-PAD folder for pad sound sources. ("File and project structure overview" on page 57)

Sound files saved in this folder can be assigned to pads.

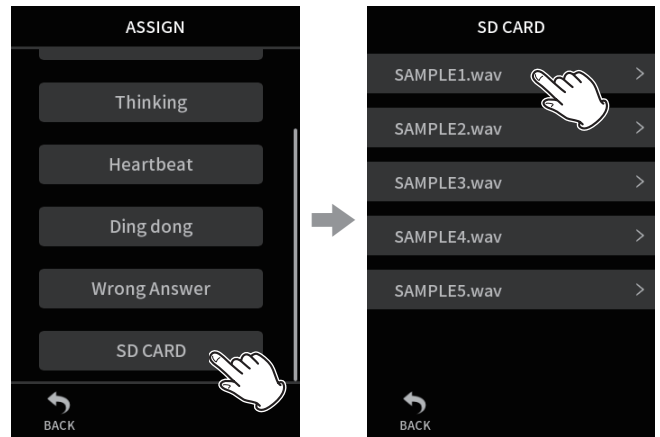

Tap SD CARD.

Tap the desired file.

NOTE

- Only sounds that are 48kHz/16-bit WAV format can be assigned to sound pads.
- If SD CARD sound sources have been assigned to sound pads, removing and inserting microSD cards or turning the unit off will reset these to the default settings of Applause and Brass.

Setting the playback method

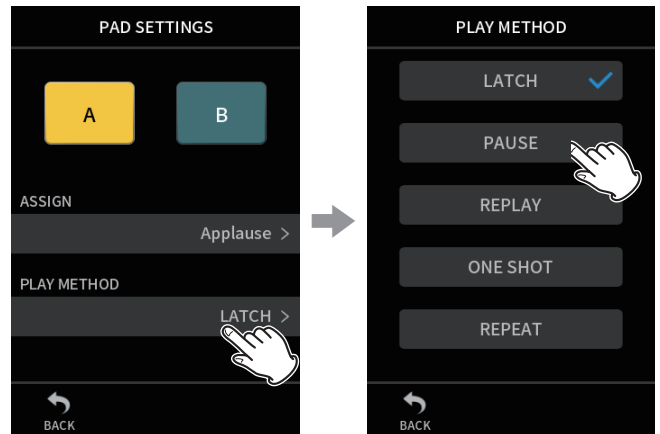

Tap PLAY METHOD.

Tap the desired setting.

LATCH (default)

Press the pad to start playback from the beginning. Press that pad again to stop playback. Press that pad once again to restart playback from the beginning.

PAUSE

Press the pad to start playback from the beginning.

Press that pad again to pause and once more to resume playback.

REPLAY

Press the pad to start playback from the beginning each time.

ONE SHOT

Press the pad to play from the beginning.

Press the pad again during playback to stop playback.

REPEAT

Press the pad to start repeat playback from the beginning.

Press the pad again to stop playback.

Playing effect sounds during recording

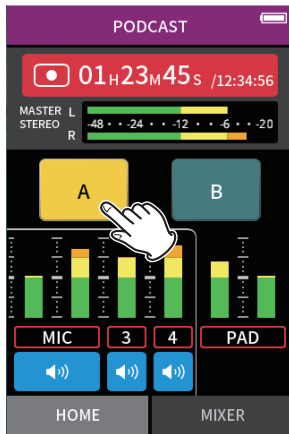

Tap a sound pad to play the sound according to the set playback method. As it plays, the sound will be recorded to the master and PAD track recording files.

NOTE

Sound pads cannot be played if an SD card is not loaded in the unit.

Muting mics

Press the mute buttons to mute and unmute channels.

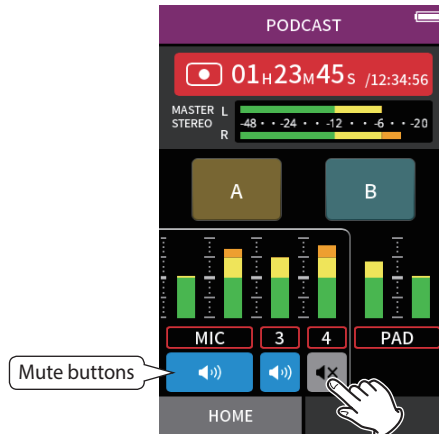

Starting playback

Press the ►/|| button to play the last recorded track file.



See "Playing files" on page 52 for other playback operations.

NOTE

- If the file was recorded when the current project was using a two-channel recording app or the MANUAL app, the master file will be played.
- The podcast app can only play files that are 48kHz sampling frequency.

7 - Recording settings

7-1 Monitoring individual inputs (solo monitoring)

In the MANUAL app, tap the meter of a track on the INPUT screen to monitor it by itself.

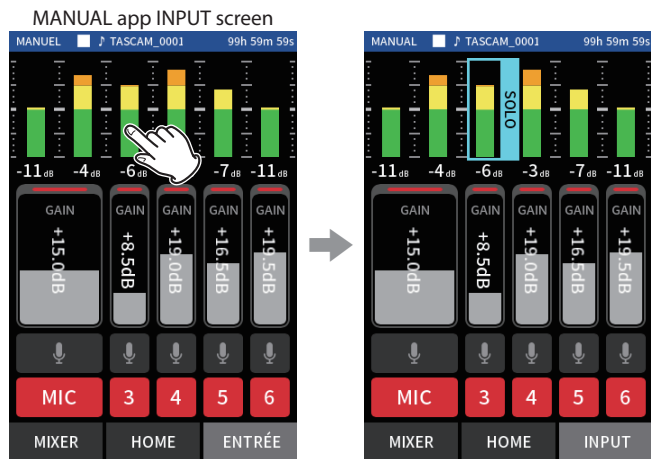

On the INPUT screen, tap the meter of the track that you want to monitor.

That meter will be framed in blue, and only the sound of that track will be output for monitoring.

- Tap the selected track again to output the MASTER signal for monitoring.

7-2 Changing the recording file format

Set this with the GENERAL SETTINGS screen > REC SETTINGS page > FILE FORMAT item.

FILE FORMAT

Select the file format.

NOTE

The following restrictions apply to MP3 file formats.

- Only sampling frequencies of 44.1 and 48 kHz can be selected
- Only the master track will be recorded (track files will not be recorded)

SAMPLE

Select the sampling frequency.

BIT DEPTH/BIT RATE

Select the bit depth/rate.

32-bit float recording

This unit supports 32-bit float recording. Files recorded using 32-bit float have the following advantages when being edited afterward.

- The levels of quiet sounds can be raised without changing their original sound qualities.
- Sounds that seem clipped can be restored to unclipped sounds by lowering their volumes.

CAUTION

Analog clipping will not be changed when volume is lowered.

NOTE

Only 48kHz/24-bit can be selected as the recording format in the PODCAST app.

7-3 Recording in mono

Change the MASTER level setting on the MIXER screen.

- This setting is only possible when using the MANUAL and PODCAST apps.

MANUAL app MIXER screen example



Tap the MASTER level setting

Tap the STEREO/MONO switch to change the setting.

7-4 Pausing during recording (REC PAUSE)

See "Recording pause function" on page 30.

7-5 Starting recording automatically (AUTO REC)

Set this with the GENERAL SETTINGS screen > REC SETTINGS page > AUTO REC item.

This function can start recording automatically.

Recording starts automatically when the recording level exceeds a set level. In addition, the unit can be set to pause the current file or start a new file when the recording level goes below a set level.

AUTO REC

Recording will occur according to the following settings when this is on.

START LEVEL

This sets the recording level that starts recording.

When OFF is selected, press the record [●] button to start recording.

END LEVEL

This sets the recording level that stops recording.

When OFF is selected, press the HOME [■] button to stop recording.

END DELAY

If the recording level goes above the END LEVEL before this time elapses, recording will continue.

END MODE

This sets what happens if the START LEVEL is exceeded again after automatic recording has been started and the recording level has gone below the END LEVEL.

SAME FILE: Recording continues in the same file

NEW FILE: Recording starts in a new file

7-6 Recording with two settings at the same time (DUAL REC)

Set this with the GENERAL SETTINGS screen > REC SETTINGS page > DUAL REC item.

This enables recording with different formats.

MP3

FLOAT

In addition to the ordinary recording, recording with the selected format will also occur.

NOTE

- MP3 dual format recording cannot be used when the sampling frequency is 96 or 192 kHz.
- FLOAT dual format recording cannot be used in the MANUAL app at 96 or 192 kHz.
- When on, the low-cut filter, noise gate, limiter, equalizer and phase inversion will affect both files.

7-7 Capturing a few seconds before starting recording (PRE REC)

Set this with the GENERAL SETTINGS screen > REC SETTINGS page > PRE REC item.

When the prerecording function is on and the unit is in recording standby, it can record up to two seconds of signal input before recording is started.

7-8 Adjusting input levels automatically (AUTO GAIN)

Set this with the AUTO GAIN item on the INPUT screen of each app.

This will automatically raise and lower the input level in response to the input signal volume. This is ideal for recording meetings and other situations when volume increases and decreases are not a problem.

7-9 Recording file naming

See "File name overview" on page 54.

7-10 Designating the folder use for recordings

See "File operations" on page 54.

7-11 Changing files while continuing to record (TIME FILE INCREMENT function)

A file with a new number can be created automatically or manually.

NOTE

- The number at the end of the file name will increment every time a new file is created.
- If the name of a newly created file would be the same as that of an existing file, the number will be incremented until the new file has a unique name.
- A new file cannot be created if the total number of files and folders would exceed 5000.

Automatic

Set this with the GENERAL SETTINGS screen > REC SETTINGS page > TIME FILE INCREMENT item.

When the set time elapses during recording, recording in the current file will stop automatically and continue in a new file.

Manual

Press the ►/|| button on the unit while recording to start a new file manually.

7 - Recording settings

7-12 Punch in/out (MANUAL app only)

This function allows recording over part of a track in an already recorded project as well as adding recording in a track while listening to another track playing.

Punching in and out

1. Launch the MANUAL app, and select the current project, which will be used for punching in/out.
See "SELECT" on page 60 for procedures to select the current file.
2. Tap the shortcut menu button, and select "PUNCH I/O" to activate punch in/out mode.



3. Play the project and determine the timing for overwriting in advance.
Select a point where the overwritten audio can be combined well with the original track audio.

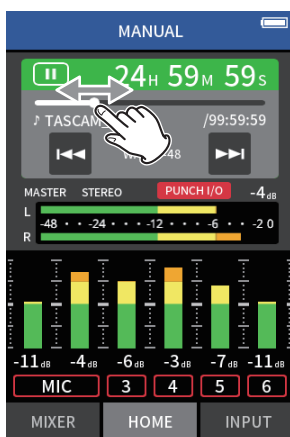

4. Open the INPUT screen, and ready the track to be overwritten for recording (red).

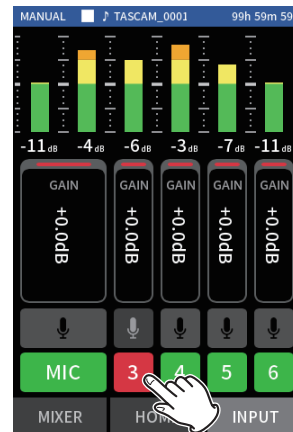

5. Press the REC [●] button at the moment to start overwriting.
The overwriting of the track enabled for recording (red) will start. (Punch in.)
During recording, sound input on both the track being overwritten (red) and the playback tracks (green) can be monitored.
6. At the end of the section to be overwritten, press the HOME [■] button to stop recording. (Punch out.)
This stops the unit.
7. Tap the shortcut menu button, and select "PUNCH I/O OFF" to deactivate punch in/out mode.

NOTE

- Since punching in/out overwrites part of a track, the audio of the master file will also be updated to reflect the change.
- When punching in/out, "EXT IN" and "USB" cannot be assigned to recording tracks as new inputs.

Undoing punching in and out (UNDO)

The most recent punch in/out recording can be undone.

1. Tap the shortcut menu button in punch in/out mode, and select "UNDO".

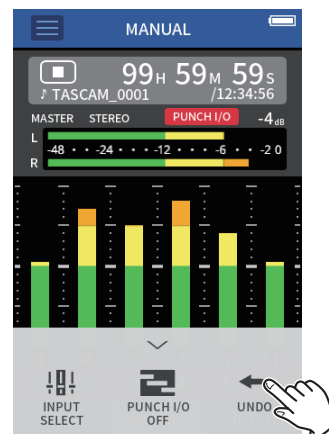

A message confirming execution of the UNDO operation will pop up.

2. Select YES.
The recording will be returned to the state before the last punch in/out operation was conducted.

Canceling UNDO operations (REDO)

1. After conducting an UNDO operation, tap the shortcut menu, and select "REDO".

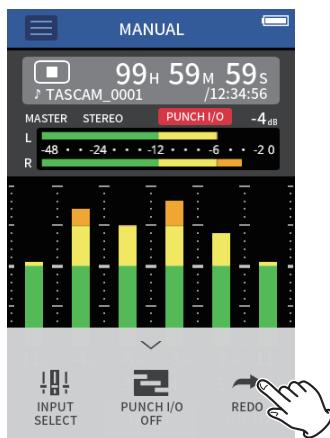

A message confirming execution of the REDO operation will pop up.

2. Select YES.
The unit will be restored to the state after the last punch in/out recording was conducted.

NOTE

- UNDO and REDO can only be used on the most recent punch in/out recording.
- If punch in/out mode is ended or the unit is turned off, the data used for UNDO and REDO operations will be lost, making them no longer possible.

7 - 13 Recording times (in hours: minutes)

File format (recording setting)		Card capacity	
		32 GB (microSDHC)	128 GB (microSDXC)
320kbps MP3 (stereo)	44.1kHz	222:13	888:53
16-bit WAV (stereo)		50:23	201:33
24-bit WAV (stereo)	96kHz	15:25	61:43
24-bit WAV (stereo)	192kHz	7:42	30:51
32-bit float WAV (stereo)	192kHz	5:47	23:08

- The recording times shown above are estimates. They might differ depending on the microSD card in use.
- The recording times shown above are not continuous recording times, but rather they are the total possible recording times for the microSD card.
- If recorded in mono, maximum recording times will be about double those above.
- If using dual recording, maximum recording times will be about half those above.

NOTE

If the size of a file exceeds 4 GB during recording, a new file will be created and recording will continue in that file (file incrementation). See "File name overview" on page 54 for information about file names.

8- Playing files

8-1 Open the playback screen

When a recording app screen is open, press the PLAY/PAUSE [▶/||] button to play the last recorded file.

Recording app screen open

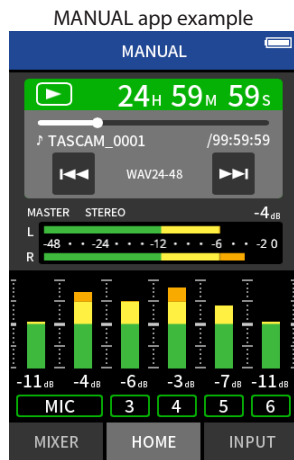

Press the PLAY/PAUSE [▶/||] button.

The last recorded file will play back.

- In the MANUAL and PODCAST apps, the track files will be played and the sound will be output from the mixer. For this reason, track output levels can be changed by adjusting the mixer settings to affect the output sound. ("Adjusting the mix balance of the tracks" on page 53)
- In the ASMR, MUSIC, VOICE and FIELD apps, master files will be played back.
- When using the PLAY menu on the BROWSE screen, master files will be played back regardless of the app used for recording.

Screen overview

Project status bar

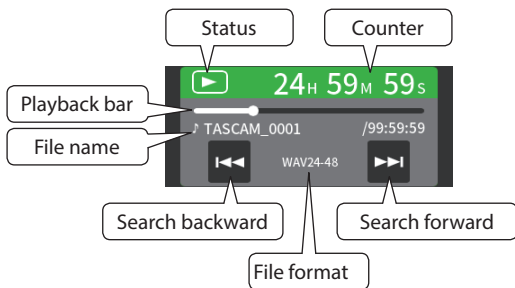

Playing and pausing

When stopped or paused, press the PLAY/PAUSE [▶/||] button to start playback.



Stopping playback

During playback, press the HOME [■] button to stop playback.



Changing the playback position

Slide the playback slider to the desired playback position.



Selecting files for playback

Use the ◀◀ and ▶▶ buttons to select a file for playback. Pressing the ◀◀ button during playback will return to the beginning of the file. Pressing the ◀◀ button at the beginning of a file will skip to the beginning of the previous file. Pressing the ▶▶ button at the beginning or middle of a file will skip to the next file.

Searching backward and forward

Use the ◀◀ and ▶▶ buttons to search backward and forward.

Adjusting the mix balance of the tracks

This operation is possible when using the MANUAL and PODCAST apps. Open the MIXER screen, and slide the faders as desired to adjust the mix balance.



Each project will play back with the mix balance used when it was recorded.

Changes to a mix balance during playback will not be saved.

Use the mixdown function to change the mix balance of a project that has already been recorded. (see "Mix down function" on page 69)

CAUTION

The mix balance will not be saved properly if the microSD card is removed from the unit during operation.

9- File operations

Recording data is saved in the SOUND folder on the microSD card. The two types of recording data are track files and master files. The types of files saved depend on the recording app. For details, see "Recording app output files" on page 13. This unit can record and play wav (including BWF) and mp3 files.

9-1 File name overview

Files recorded by this unit are named as described below.

Project name Track number
└──────────┬──┘
TASCAM_0001_1.wav
└──┬──┘
 └──┘

Characters set by user File number

Characters set by user

When TYPE is set to DATE

YYMMDD (YY: year, MM: month, DD: date)

Two digits each are used for the year (last two), month and date.

When TYPE is set to WORD

A string of 6–9 characters can be specified as wanted.

The default value is "TASCAM".

The usable characters are as follows.

Uppercase and lowercase alphabet letters numerals 0–9, and the following symbols:

! # \$ % & ' () + , - . : ; = @ [] ^ _ ` { } ~ (space)

File numbers

This shows the order recorded.

The default value is "0001".

For dual files

DUAL FORMAT

FLOAT: File number+F

MP3: File number+M

For mixed down files

File number+MIX+number of times

For divided files

File number+A (B, C, D...)

For files divided by marks

File number+number of times (01, 02, 03...)

Track number

This shows which track was recorded. This is only added to track files.

When stereo-linking off

Track number 1, 2, 3, 4, 5, 6

When stereo-linking on

Linked track numbers 1–2, 3–4, 5–6

For master files

None

Project name

This is the characters set by the user and the file number connected by an underscore (_).

Since the file number is increased each time a file is recorded, the project also changes with each recording. See "Project overview" on page 57 for details.

File name examples

The tables below show how, starting with the following conditions, files are named according to the settings.

Characters set by user: TYPE set to WORD (TASCAM)

File number: 0001

With 2-channel recording apps (ASMR, MUSIC, VOICE, FIELD)

Settings	File names	File types
1st recording	TASCAM_0001.WAV	Master file
2nd recording	TASCAM_0002.WAV	Master file

With MANUAL and PODCAST apps

Settings	File names	File types	
Tracks 1–4 set to mono	TASCAM_0001_1.WAV TASCAM_0001_2.WAV TASCAM_0001_3.WAV TASCAM_0001_4.WAV TASCAM_0001_MIX.WAV (master files are always created)	Track file Track file Track file Track file Master file	
Tracks 1–2 and 3–4 stereo-linked	TASCAM_0001_1-2.WAV TASCAM_0001_3-4.WAV TASCAM_0001_MIX.WAV (master files are always created)	Track file Track file Master file	
Tracks 1–2 set to mono Tracks 3–4 stereo-linked	TASCAM_0001_1.WAV TASCAM_0001_2.WAV TASCAM_0001_3-4.WAV TASCAM_0001_MIX.WAV (master files are always created)	Track file Track file Track file Master file	
Dual files (handled as separate projects)	DUAL FORMAT (FLOAT)	TASCAM_0001_1.WAV TASCAM_0001F_1.WAV	
	DUAL FORMAT (MP3)	TASCAM_0001_1.WAV TASCAM_0001M_1.MP3	
File division	TASCAM_0003_1-2.WAV ↓ TASCAM_0003_A_1-2.WAV (treated as separate project) TASCAM_0003_B_1-2.WAV (treated as separate project)	Manually-divided file Manually-divided file	
	TASCAM_0003_1-2.WAV ↓ TASCAM_0003_01_1-2.WAV (treated as separate project) TASCAM_0003_02_1-2.WAV (treated as separate project)	Mark-divided file Mark-divided file	

With MANUAL app

Mixdown files	TASCAM_0002_1.WAV TASCAM_0002_2.WAV TASCAM_0002_3.WAV TASCAM_0002_4.WAV When the 4 files above are mixed down ↓	Track file Track file Track file Track file
	TASCAM_0002MIX.WAV (created as separate project) TASCAM_0002MIX2.WAV (created as separate project distinct from the first)	Mixdown file Mixdown file

9 - File operations

Changing how files are named

Set this with the GENERAL SETTINGS screen > SYSTEM page > FILE NAME item.

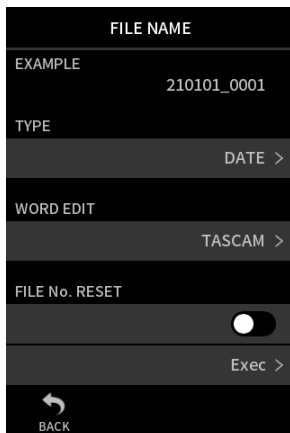

EXAMPLE

The result of the current settings can be checked here.

TYPE

Set the characters used at the beginning of the file name.

DATE

The DATE is added to the file name.

YYMMDD (YY: year, MM: month, DD: date)

The last two digits of the year are used, and two digits each are used for the month and date.

WORD

The 6–9 characters set with WORD EDIT are added to the file name.

The default value is "TASCAM".

WORD EDIT

Use this to input the file name.

For details about character input, see "App overview" on page 11.

NOTE

If DATE is selected, the file name will be created using the date and time of the unit's internal clock. Set the clock in advance to enable recording with the correct date and time.

Resetting the file number

Set this with the GENERAL SETTINGS screen > SYSTEM page > FILE NAME item.

FILE No. RESET setting

OFF (default)

The file number will not be reset.

ON

The file number will automatically be reset when formatting, creating a new folder, or deleting all the files in a folder.

Exec

This will reset the file number the next time a file is created.

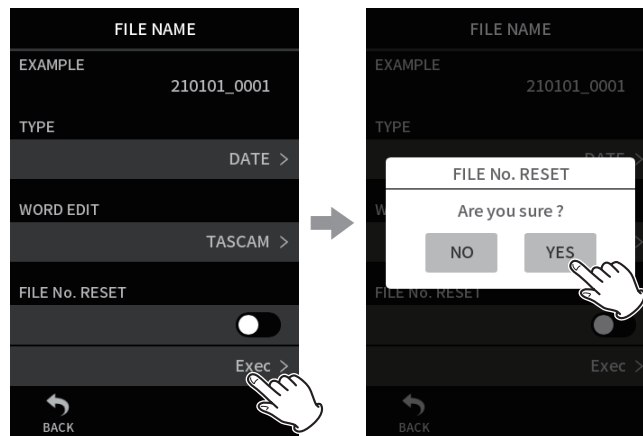

Tap Exec.

Tap YES.

9-2 File and project structure overview

Folders

Formatting microSD cards with this unit will create SOUND, UTILITY and SOUND PAD folders.

Recording data is saved in the SOUND folder.

Folders can be created inside the SOUND folder.

Create them as necessary. (page 59)

Recording data

Recorded data is saved in the current folder.

After a microSD card is formatted, the SOUND folder becomes the current folder.

To change the current folder, select the folder on the BROWSE screen, and tap OPEN. ("Setting where recording files are saved" on page 63)

9-3 Folder hierarchy example

This illustration is an example of the folder hierarchy on a microSD card used with this unit.

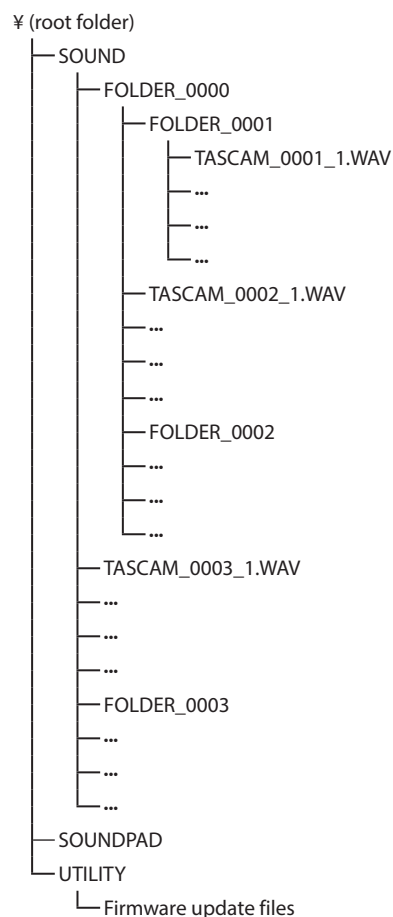

- SOUND, UTILITY and SOUNDPAD folders will be created automatically during formatting.
- Only two levels of subfolders can be created.
- The maximum total number of files and folders is 5000.
- Everything in the SOUND folder and its subfolders is shown on the BROWSE screen.

9-4 Project overview

The track and master files created during a single recording are referred to collectively as the project.

Files belong to the same project if the characters set by the user through the file numbers in their names are the same. See "File name overview" on page 54 for details about project names. The way project names are given can be changed in the same manner as for file names. ("Changing how files are named" on page 56)

Example

Project name	Files in the same project	File types
TASCAM_0001	TASCAM_0001_1.WAV	Track file
	TASCAM_0001_2.WAV	Track file
	TASCAM_0001_3.WAV	Track file
	TASCAM_0001_4.WAV	Track file
	TASCAM_0001_MIX.WAV	Master file
TASCAM_0002	TASCAM_0002.WAV	Master file

- Track files might not be created depending on the recording app. See "Recording app output files" on page 13 for details.
- Individual files not created by this unit and loaded from a computer or other source are each treated as a single project.

9 - File operations

9-5 Using the BROWSE screen

Tap the Shortcut Menu button on the app screen to open the BROWSE screen.

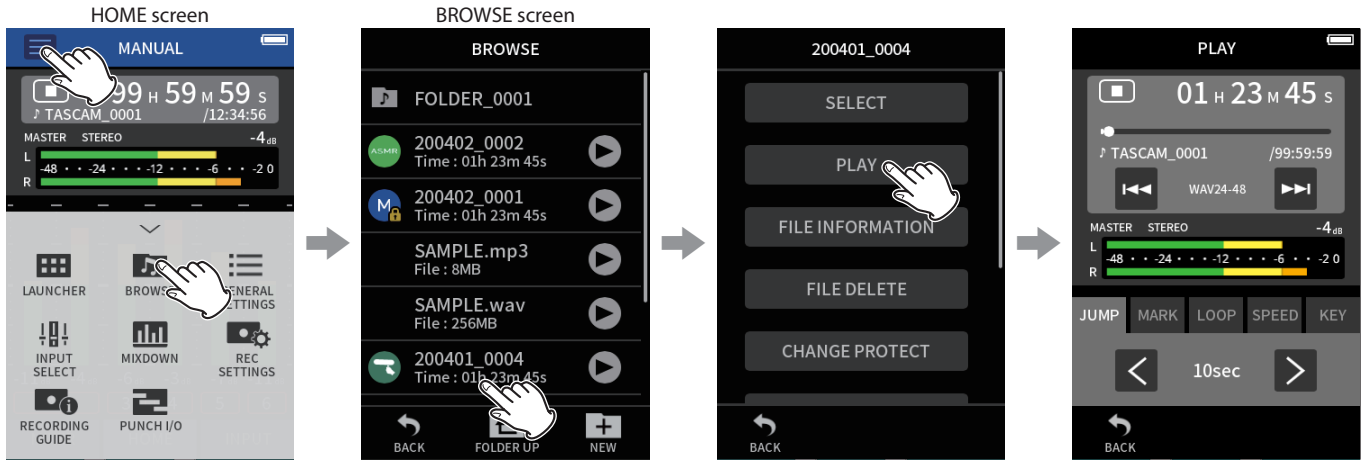

Tap the Shortcut Menu button. Then, tap the BROWSE icon.

Tap the desired file.

Tap the desired menu item.

9-6 Folder operations

Screen overview

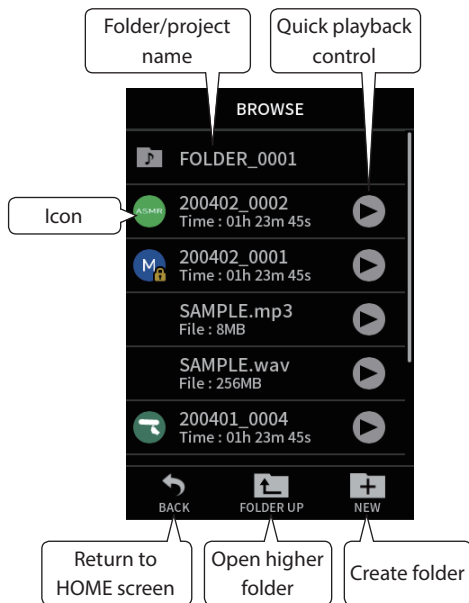

Icon



The apps used to record files on this unit are shown with icons. Folders are shown with .

Folder/file name

Folder names are shown for folders.

If files were recorded by this unit, their file names and recording times are shown. If files were not recorded by this unit, their file names and file sizes are shown.

Quick playback control

Tap  to start playback, and tap  to stop playback.

Basic operation

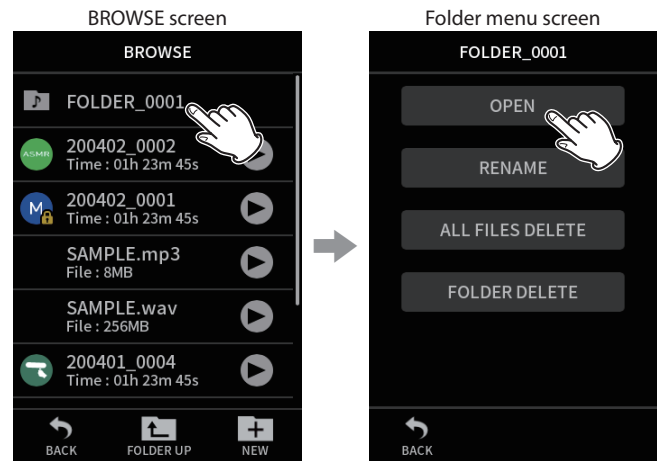

Tap the desired folder.

Tap the desired operation.

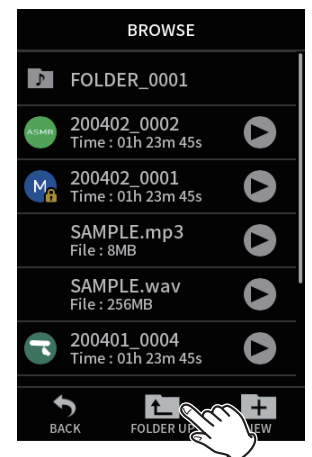

Tap FOLDER UP to move up one folder level.

OPEN

This shows the contents of the folder.

RENAME

This opens the RENAME screen where the folder name can be edited.

ALL FILES DELETE

This deletes all projects and files inside the folder. Folders, however, will not be deleted.

FOLDER DELETE

This deletes the folder and the files and folders inside it.

Creating folders (NEW)

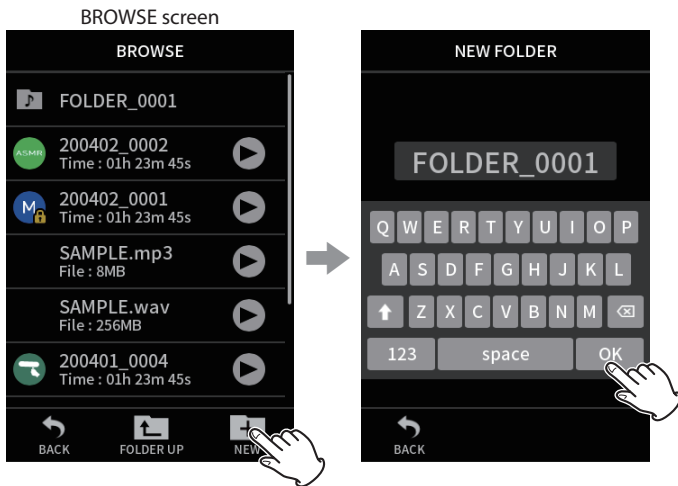

Tap the NEW icon.

Tap OK to create a folder with the name shown.

- If a folder named FOLDER+number already exists, tapping the NEW icon will show FOLDER+(number+1) as the default value. If you want to change this name, delete it once and input it again.
- See “Character input” on page 17 for how to input characters.

Changing the names of folders (RENAME)

Tap the desired folder on the BROWSE screen, and do the following.

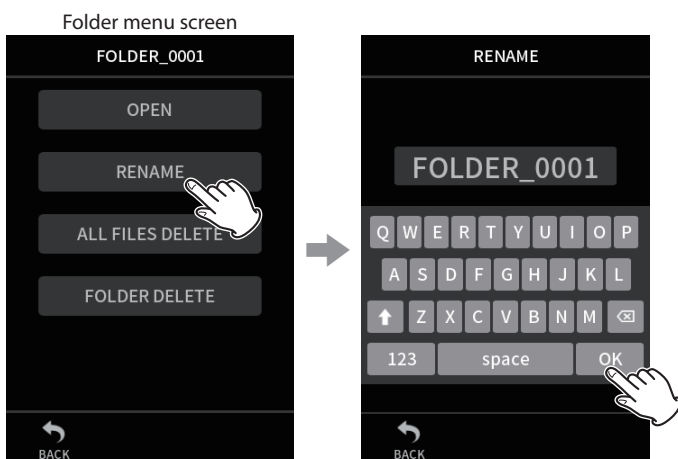

Tap RENAME.

Input the folder name and tap OK.

- See “Character input” on page 17 for how to input characters.
- The number of characters in folder names can be changed to be between 1 and 11.

Deleting all files in a folder (ALL FILES DELETE)

1. Tap the desired folder on the BROWSE screen.
2. Tap ALL FILES DELETE.

NOTE

The selected folder will not be deleted.

Deleting folders (FOLDER DELETE)

1. Tap the desired folder on the BROWSE screen.
2. Tap FOLDER DELETE.

NOTE

Folders that have files remaining in them cannot be deleted. Delete all the files in the folder before deleting the folder.

9 - File operations

9-7 File and project operations

Basic operation

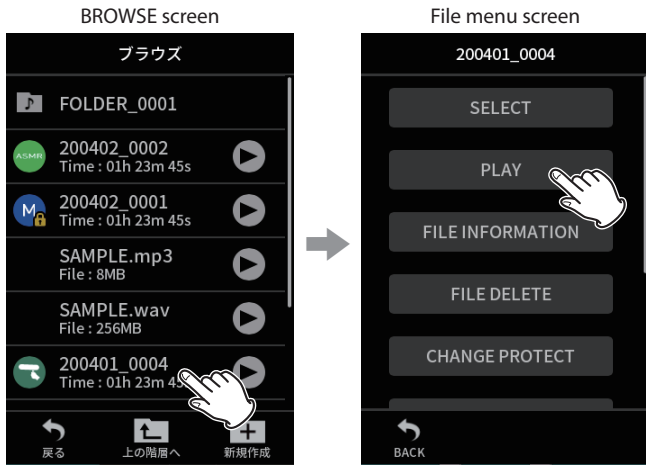

Tap the desired file.

This opens the operation menu.
Tap the desired operation.

SELECT

This sets the selected file as the current project.

PLAY

This plays the master file of the selected project.

FILE INFORMATION

This shows information about files in the project.

FILE DELETE

This deletes the file.

TRACK DELETE

Use this to select and delete track files in the project.

- This is shown when a recorded file is selected in the MANUAL or PODCAST app.

CHANGE PROTECT

Use this to activate/deactivate the protection of files in the project.

RENAME

Use this to change the project name.

- Only projects that have been recorded by this unit can be changed. The number of characters can be changed to between 6 and 9.

MARK

This opens a list of the marks.

DIVIDE

Use this to divide files.

NORMALIZE

Use this to normalize files.

SELECT

The selected file becomes the current project, and the app used for recording appears on the HOME screen.

Press the PLAY/PAUSE [▶/||] button to play track files in the current project.

NOTE

If a file not created by this unit is selected, it will be played using the MANUAL app.

Current project

The name of the file shown in the project status bar is the current project. Conducting recording or playback will switch the current project.

Playing master files(PLAY)



1. Tap the name of the file to play on the BROWSE screen.
2. Tap PLAY.
This opens the PLAY screen.
3. Press the PLAY/PAUSE [▶/||] button on the unit.

NOTE

- Tapping the quick playback ▶ button on the BROWSE screen will also start playback.

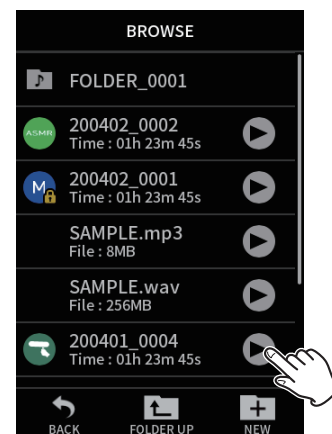

- Starting playback from the BROWSE screen will play the master file.

To adjust the mix balance during playback of tracks recorded using the MANUAL or PODCAST app, set the project to be played as the current project (see previous section), open the MIXER screen of that app, and press the PLAY/PAUSE [▶/||] button on the unit. ("Adjusting the mix balance of the tracks" on page 53)

Jumping 10 seconds backward/forward

Tap the JUMP playback control, and tap the < and > buttons to jump.

Jumping to mark locations

1. Tap the MARK playback mode tab.



2. Tap < or > to jump.



Tap the flag icon to select which marks to use when skipping between marks.

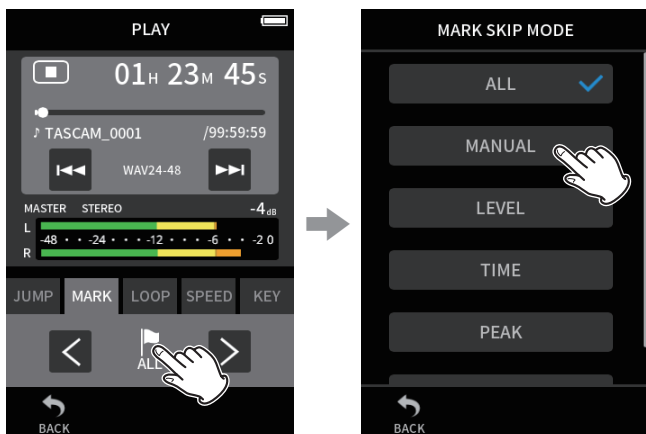

ALL
Skip between all marks

MANUAL
Skip between marks that were added manually

LEVEL
Skip between LEVEL marks that were added using the automatic mark function

TIME
Skip between TIME marks that were added using the automatic mark function

PEAK
Skip between marks added when a PEAK indicator lit

BOF
Skip between marks added when microSD card write errors occurred during recording

NOTE
See "Playing files" on page 52 to view the mark list or delete them all at once.

Looping playback

Intervals between two points in a single file can be played repeatedly (loop playback).

1. Tap the LOOP playback mode tab.
2. When playing or paused, tap the IN button to set the playback starting point.
The playback starting point (IN) will be shown on the playback bar.
3. When playing or paused, tap the OUT button to set the playback ending point.
The playback ending point (OUT) will be shown on the playback bar.
Playback will start from the playback starting point.

NOTE
Returning to the HOME screen will clear the playback starting (IN) and ending (OUT) points.

Ending loop playback

Tap the LOOP RESET button at the bottom of the screen to clear the starting and ending points.

Changing the playback speed (VSA playback)

1. Tap the SPEED playback mode tab.
2. Tap the DOWN and UP buttons to adjust the playback speed as desired.

Changing the playback pitch (KEY)

1. Tap the KEY playback mode tab.
2. Tap ♭ or # to adjust the pitch.

NOTE
VSA playback and pitch change functions cannot be used with 96/192kHz files.

9 - File operations

Viewing file details (FILE INFORMATION)

1. Tap the name of the file to view on the BROWSE screen.
2. Tap FILE INFORMATION.
Information about the selected file will be shown.

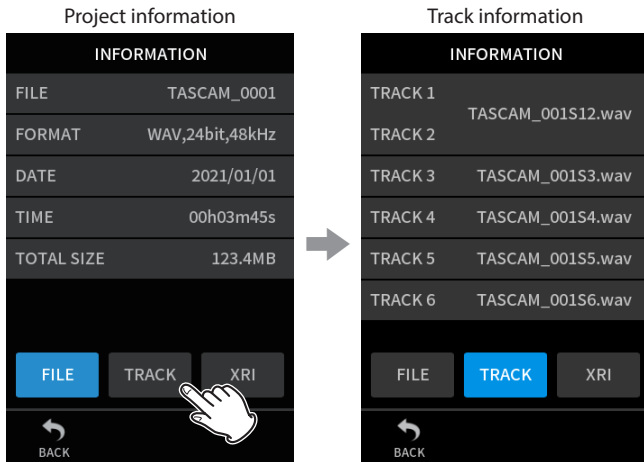

Tap TRACK.

FILE

This shows the project name, recording format, recording date, playback time and file size.

TRACK

This shows all the track files in the project. If the project has no track files or was not recorded by this unit, only the master file will be shown.

Deleting files and projects (FILE DELETE)

1. Tap the name of the project to delete on the BROWSE screen.
2. Tap FILE DELETE.

NOTE

A protected (read only) file cannot be deleted.

Deleting tracks in projects (TRACK DELETE)

1. Tap the name of the project to delete on the BROWSE screen.
2. Tap TRACK DELETE.
3. Tap all the track files to be deleted.

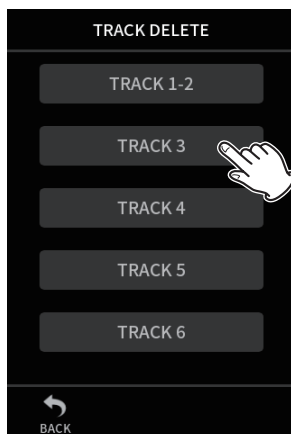

NOTE

- Tracks can only be deleted in projects recorded using the MANUAL and PODCAST apps.
- Deletion of the contents of tracks does not affect master files.

Enabling and disabling protection (CHANGE PROTECT)

Project protection can be enabled and disabled.

1. Tap the name of the file to change protection for on the BROWSE screen.
2. Tap CHANGE PROTECT.
This enables or disables protection.

NOTE

Lock marks (🔒) will be shown to the bottom right of icons for files that are protected

Changing names (RENAME)

Project names can be changed.

1. Tap the name of the project to change on the BROWSE screen.
2. Tap RENAME.
3. Input the new project name and tap OK.
 - See "Character input" on page 17 for how to input characters.

Viewing the mark list (MARK)

1. Tap the name of the file to view on the BROWSE screen.
2. Tap MARK.
A list of marks will be shown

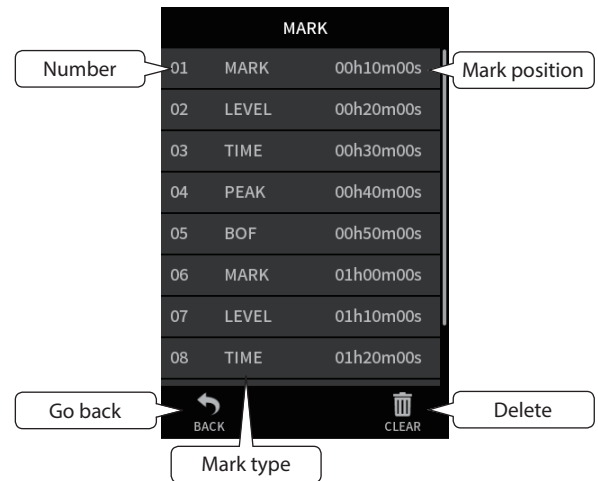

See "Mark functions" on page 64 for information about mark types.

Deleting marks

Tap the trashcan icon to delete all marks.

NOTE

See "Deleting marks" on page 64 for details about the deleting individual marks.

Dividing files (DIVIDE)

1. Tap the name of the project to divide on the BROWSE screen.
2. Tap DIVIDE.
3. Move the pointer on the playback bar to the division point. Move the playback pointer by, for example, playing the file, searching forward/backward, and sliding it along the playback bar.

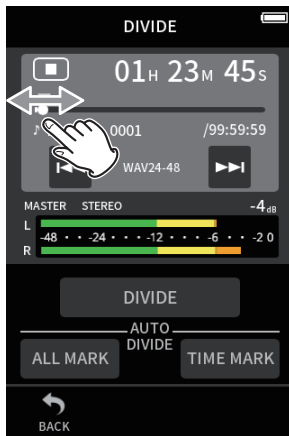

4. Tap DIVIDE.

NOTE

- If the project has track files, the track files will also be divided.
- Tap ALL MARK to divide the file at every mark position.
- Tap TIME MARK to divide the file at every mark added by the automatic mark function TIME option.
- Only files in projects that have been recorded by this unit can be divided.
- MP3 files cannot be divided.
- The DIVIDE function does not affect PEAK marks.

Normalizing recordings (NORMALIZE)

This function finds the loudest volume in a recorded file and raises the volume of all the recording data so the loudest volume is at the maximum level.

1. Tap the name of the file to normalize on the BROWSE screen.
2. Tap NORMALIZE.

NOTE

- Since the data of the selected project will be overwritten, it cannot be restored.
- Only files recorded by this unit can be normalized.
- This function is applied to master files. It does not affect track files.

9-8 Setting where recording files are saved

Recording data is saved in the current folder.

Follow the procedures below to select a folder and make it the current folder.

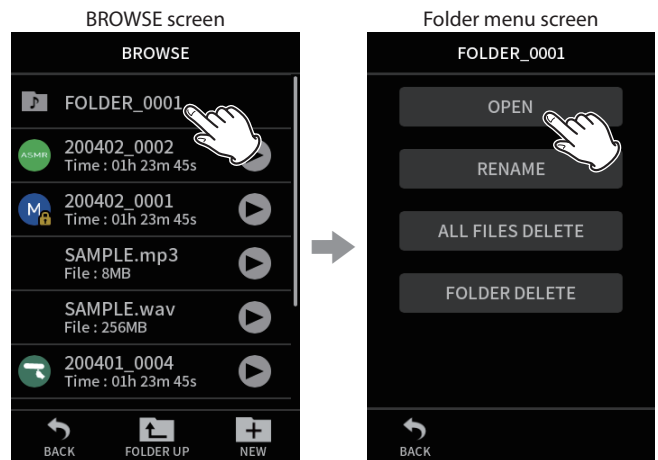

Tap the folder to make current.

Tap OPEN.

NOTE

When the current file is selected, its folder becomes the current folder.

10 - Mark functions

10-1 Mark types

The types of marks and conditions when they are added are as follows.

MANUAL

Marks added manually

LEVEL

Marks added when input signal exceeds specified level

TIME

Marks added when set time elapses

PEAK

Marks added when input signal exceeds peak level

BOF

Marks added when microSD card write errors occur during recording

10-2 Adding marks

Adding marks manually

When playing, recording or in recording standby, press the MARK button to add a mark at any point.

When a mark is added, a pop-up with mark information appears at the bottom of the display.

Adding marks automatically (AUTO MARK)

Set this with the GENERAL SETTINGS screen > OTHER SETTINGS page > AUTO MARK item.

OFF

Marks will not be added automatically.

LEVEL

Marks will be added automatically when the input signal exceeds the set level.

TIME

Marks will be added automatically when the set time elapses during recording.

Adding marks when peak levels occur (PEAK MARK)

Set this with the GENERAL SETTINGS screen > OTHER SETTINGS page > PEAK MARK item.

When this is on, marks will be added automatically when input signals exceed the peak level during recording. This can be used after recording to find parts where the peak level was exceeded.

10-3 Deleting marks

A mark can be deleted by pressing the MARK button when stopped or paused at its position. When a mark is deleted, a pop-up with information about the deleted mark appears at the bottom of the display.

Deleting all marks

See "Deleting marks" on page 62.

10-4 Jumping to set marks (mark skipping)

See "Jumping to mark locations" on page 61.

NOTE

Marks in different files cannot be skipped to.

10-5 Dividing files at every mark

See "Dividing files (DIVIDE)" on page 63.

10-6 Opening mark lists

See "Viewing the mark list (MARK)" on page 62.

11 - 1 Setting the output for camera use

Set this with the GENERAL SETTINGS > CAMERA SETTINGS > OUTPUT item.

When connecting the LINE OUT jack to a camera, LINE OUT jack output can be attenuated -20 to -30 dB. This enables inputting audio to the camera at a suitable level.

When OUTPUT is set to CAMERA, the output from the LINE OUT jack is attenuated -20 dB.

Slide the LEVEL slider left and right to adjust the attenuation in a range from -20 to -30 dB.

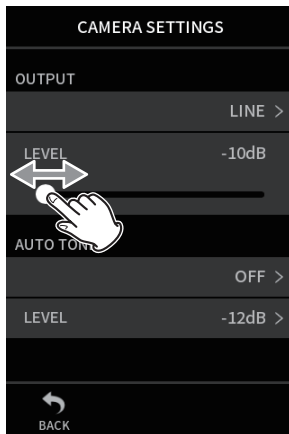

11 - 2 Using the auto tone function (AUTO TONE)

Set this with the GENERAL SETTINGS screen > CAMERA SETTINGS > AUTO TONE item.

The auto tone function can be used to automatically insert a tone signal whenever recording starts and stops.

By connecting the LINE OUT jack on the left side of the unit to the audio input jack of a camera, both units can record the same tone signals to their files. These tones can be used as guides to synchronize files in video editing software.

Setting the AUTO TONE function

Set where tone signals are inserted.

OFF

No tone signals are inserted.

HEAD

Tone signals are only inserted at the start of recording.

HEAD+TAIL

Tone signals are inserted at both the start and end of recording.

Adjusting the tone volume

Set the tone volume.

The default value is -12 dB.

12 - USB connection

12-1 Connecting with computers

See “Connecting computers and smartphones” on page 25.

12-2 Connecting with iOS devices

To connect with an iOS device, a Lightning to USB Camera Adapter and a USB cable (Type-A to Type-C) are necessary.

NOTE

This unit will not provide power to an iOS device when they are connected.

12-3 Accessing microSD cards from a computer

On the GENERAL SETTINGS screen OTHER SETTINGS page, select the SD CARD READER item.

The unit display will change. The microSD card in the unit can be accessed when it is recognized by the computer.

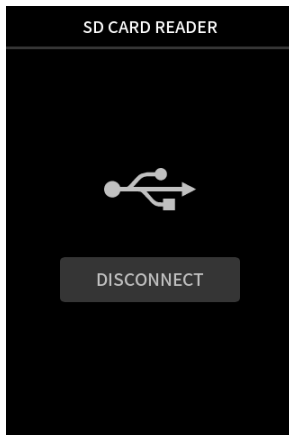

Exchanging files with computers

Click the “X8” drive on the computer to show the SOUND, SOUND PAD and UTILITY folders.

To transfer files from the computer, drag and drop the desired audio files on the computer to the SOUND folder. To transfer files from the microSD card to the computer, drag and drop the desired audio files from the SOUND folder to any folder on the computer.

TIP

- The SOUND folder can be managed from the computer.
- Subfolders can be created in the SOUND folder. Only two levels of subfolders can be created. This unit cannot recognize subfolders and audio files on the third level or below.

NOTE

Follow the procedures specified for the computer to disconnect the unit from it.

12-4 Using the ASIO driver

A Portacapture X8 ASIO driver can be used with Windows. Check the page for this product on the TASCAM website (<https://tascam.jp/int/>) for details.

NOTE

With a Mac, the standard OS driver will be used, so there is no need to install any software.

12-5 Using as an audio interface

This unit can be used as a USB audio interface by connecting it to a computer using a USB cable.

- The USB audio function does not support the 192kHz sampling frequency.
- Sound played back on this unit can be output over USB.

When a microSD card is loaded

1. Manually set this unit and the computer to use the same sampling frequencies.
See “Changing the recording file format” on page 48 for procedures to change the sampling frequency of this unit.
2. After changing the sampling frequency, starting recording or recording standby will cause audio to be transmitted.

When a microSD card is not loaded

This unit will operate using the sampling frequency of the computer.

Portacapture X8 USB audio channel assignments

USB channels	Signals
USB IN 1-2	Stereo mix
USB IN 3-4	INPUT 1-2 input signals
USB IN 5-6	INPUT 3-4 input signals
USB IN 7-8	INPUT 5-6 or EXT IN input signals

- The signals sent over USB vary according to the type of recording app being used and the input on/off settings.

MANUAL, PODCAST

Signals assigned to tracks with input on and a stereo mix are sent over USB.

ASMR, MUSIC, VOICE, FIELD

Signals assigned to TRACK 1-2 and a stereo mix are sent over USB.

- Settings affect USB audio signals as follows.

Menu item	Function	USB IN 3-8 (INPUT 1-6)	USB IN 1-2 (MIX)
INPUT SETTINGS	GAIN (AUTO GAIN)	○	○
	LOW CUT	–	○
	NOISE GATE	–	○
	LIMITER/COMP	–	○
	EQ	–	○
MIXER	PHASE INVERT	○	○
	Fader (Track1-6)	–	○
	Fader (MASTER)	–	○
	PAN	–	○
I/O SETTINGS	STEREO/MONO	–	○
	MIC TRIM	○	○
	MS DECODE	–	○
	REVERB (Track1-6)	–	○
CAMERA SETTINGS	REVERB (MASTER)	–	○
	AUTO TONE	–	○

○: Affect signals

–: Do not affect signals

12-6 Using the unit as a USB mic

By connecting this unit with a computer using a USB cable, you can use it as a USB mic for online communication and streaming, for example. Up to six inputs can be used with the MANUAL app.

NOTE

The automatic power saving function is disabled when in USB audio interface mode.

Inputting sound to the computer using the unit inputs

1. Use a USB cable to connect the computer and the unit.
2. Set the audio input device to "Portacapture X8" on the computer. Set this unit and the computer to use the same bit depths and sampling frequencies.
3. Launch the recording app to be used. If using the MANUAL or PODCAST app, enable input of the tracks assigned to the input jacks to be used as computer inputs.



If using the ASMR, MUSIC, VOICE or FIELD app, signals from the input jacks assigned to TRACK 1-2 in the INPUT SELECT settings will automatically be used as the computer inputs. Signals from other input jacks will not be input to the computer.

Using the computer output as sound input to this unit

1. Use a USB cable to connect the computer and the unit.
2. Set the audio output device to "Portacapture X8" on the computer. Use the same sampling frequency settings for both the unit and the computer.
3. Launch the MANUAL or PODCAST app.
4. Select INPUT SELECT from the Shortcut Menu, and select USB for tracks to assign sound from the computer to them.

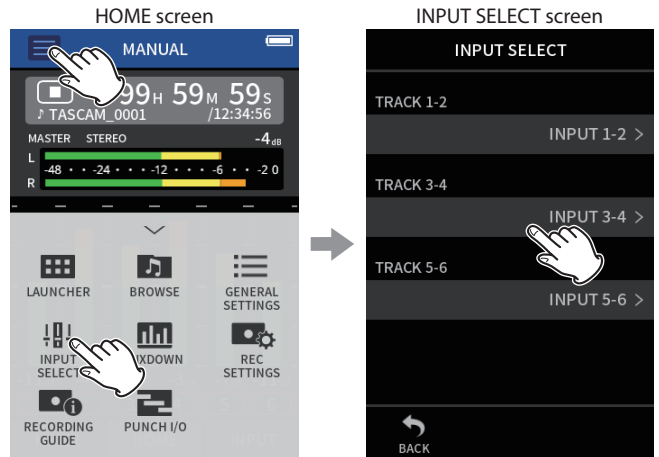

Tap the Shortcut Menu (≡) button. Then, tap INPUT SELECT.

Tap the track to have USB as assigned.

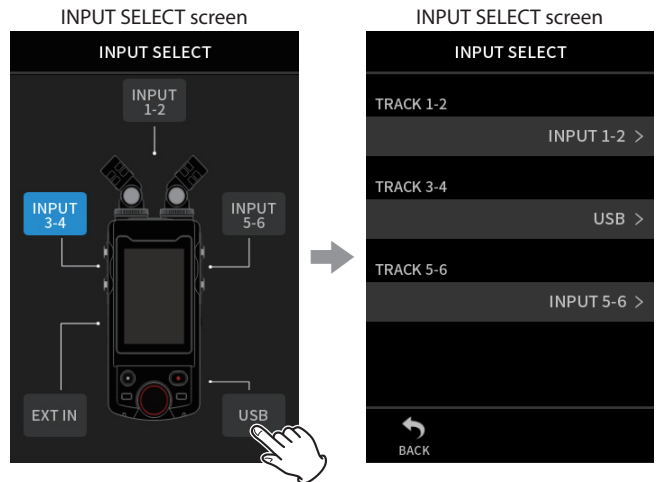

Tap USB.

5. Enable input of the track that has USB assigned.

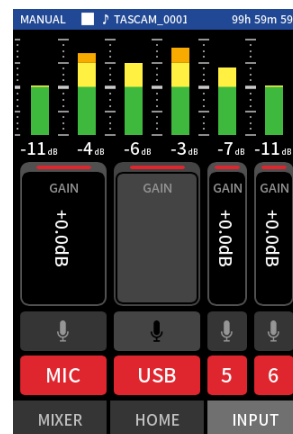

12 - USB connection

CAUTION

Completing these procedures in addition to the procedures in “Inputting sound to the computer using the unit inputs” above could cause feedback if input monitoring is enabled in the software being used (DAW or calling/streaming app, for example). This might cause sudden loud noises, which could damage the equipment or harm hearing.

When returning the input sound of this unit back to it from a computer, turn input monitoring off in the software and apps on the computer.

NOTE

Adjust the USB volume from the computer.

13 - Other functions and apps

13-1 METRONOME app

This unit includes a metronome app. Click sound and metronome settings can be made.

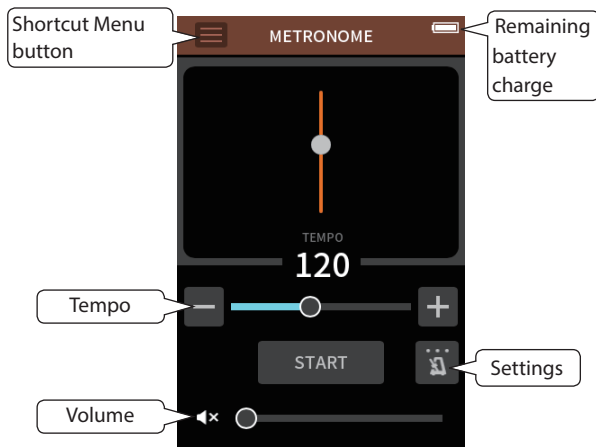

Press the START button to run the metronome. Press the button again to stop it.

Tempo

This sets the speed in a range from 20 to 250 (BPM). (Default: 120)

Volume

This adjusts the metronome volume.

Activation setting

BEAT

Set the number of beats.

1-9 (default: 4)

SOUND

Set the click sound.

CLICK (default)

STICK

BELL

NOTE

- When the metronome is running, its sound can be monitored through connected speakers. This could cause the metronome sound to be recorded if a microphone is being used.
- The BEAT value is always quarter notes.

13-2 TUNER app

This tuner has a chromatic tuning mode, which allows instruments to be tuned while checking a tuning meter, and an oscillator mode that outputs a standard pitch.

Tuning by pitch

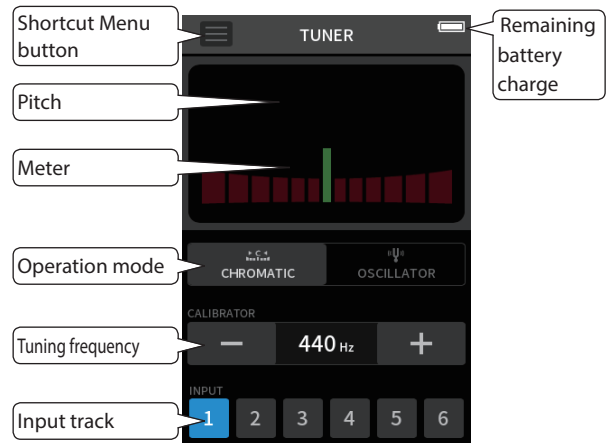

1. Set the operation mode to CHROMATIC.
2. Set the tuning frequency.
3. Select a track to use for tuning.
4. Input a sound from the instrument to be tuned. The closest pitch name will be shown above the center of the meter. Tune the instrument so that the target pitch name appears and the center of the tuner lights. A bar appears to the left or right of center if the sound is lower or higher than the target pitch. The meter extends further as the discrepancy becomes larger.

Tuning by standard pitch

Tuning tones can be output from the LINE OUT jack in a three-octave range (C3 – B5).

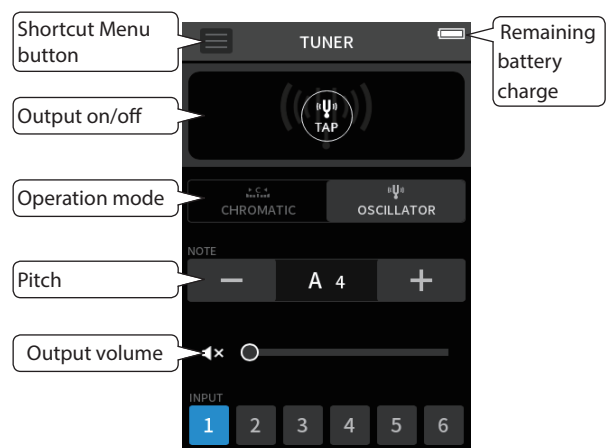

1. Set the operation mode to OSCILLATOR.
2. Set the pitch.
3. Set the output level.
4. Tap the TAP icon to turn tone output on.

13-3 Mix down function

13 - Other functions and apps

In the MANUAL app, the volume levels and panning settings of each track in an existing project can be adjusted to create a new mix.

1. Launch the MANUAL app.

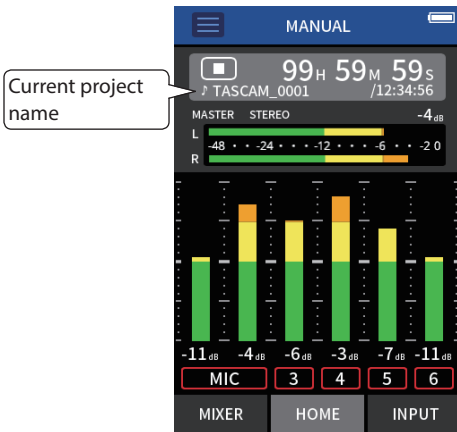

2. Make the project to be mixed down the current project. See "SELECT" on page 60 for procedures to select the current project.
3. While the current project is playing, use faders, panning and other controls on the MIXER screen to adjust the volume and stereo positioning of each track. See "Using the mixer" on page 36 for adjustment procedures.

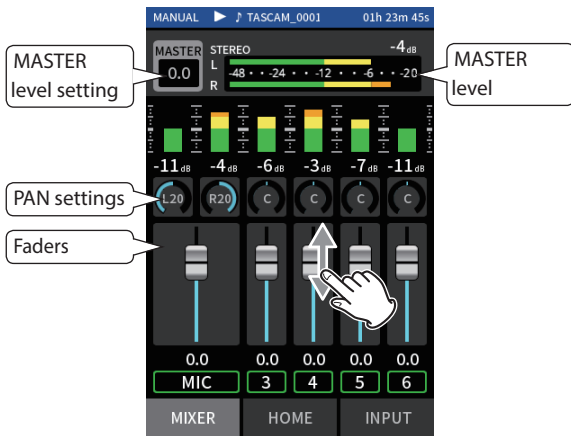

4. Tap the Shortcut Menu (☰) button. Then, tap MIX DOWN to execute the mix down.

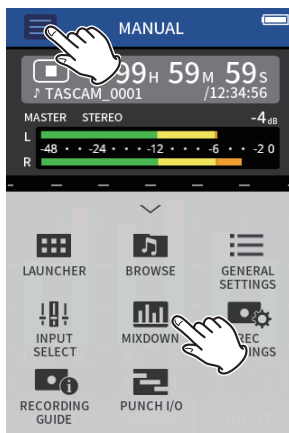

5. A master file of the mix will be created in a new project.

NOTE

See "File name overview" on page 54 for information about the names of mix down files.

13-4 Mid-side decoding function

In the MANUAL app, mid-side mics can be used for recording, and their recordings played back.

See "Connecting mid-side mics" on page 23 for details about connecting mid-side mics to this unit.

Connection settings

Set the jacks that the mid-side mics are connected to using the GENERAL SETTINGS screen > I/O SETTINGS > MS DECODE item.

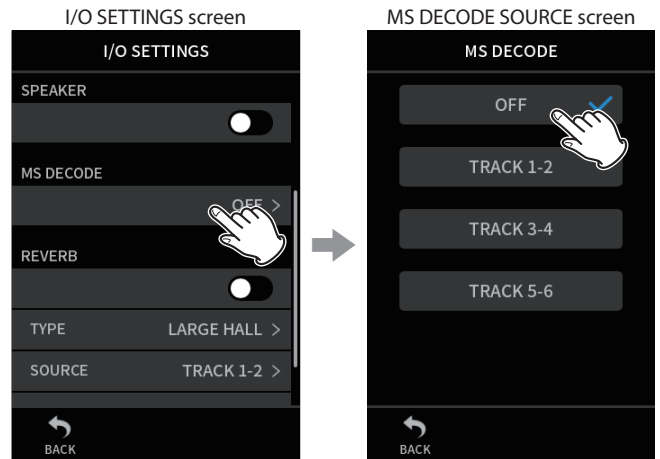

Tap MS DECODE.

Tap the tracks that have mid-side mics connected.

NOTE

- The mid-side decode function can be used when inputting mid-side mics on input jacks 3/4 or 5/6 and when using this unit to play an imported file recorded using mid-side mics. Turn this off when mid-side mics are not connected.
- Always stereo-link the inputs to which mid-side decoding is applied. See "Using the STEREO LINK function" on page 27 for operation procedures.

Adjusting mid and side levels

1. Launch the MANUAL app, and open the MIXER screen.
The pan settings for the tracks selected for MS DECODE will become the MS decode setting.
2. Tap the MS decode setting, and slide the slider left and right to adjust the width of the sound.
At 0, the sound will be 100% mid (M). The amount of side (S) increases with the value.



Tap the MS decode setting.

Slide the slider left and right to adjust the width of the sound.

14- Controller app

When an AK-BT1 Bluetooth adapter is connected to the Bluetooth device connector of this unit, this unit can be controlled from an iOS/Android device using a controller app.

14-1 Installing the dedicated controller app

1. Connect the device to the Internet.
 2. Search for "Portacapture Control" on Google Play for an Android device or on the App Store for an iOS device. Then, download and install it.
- Please be aware that you are responsible for any transmission costs related to Internet connection.

14-2 Connecting with this unit using Bluetooth

1. Remove the cover from the Bluetooth connection device port on this unit, and install an AK-BT1 in it.

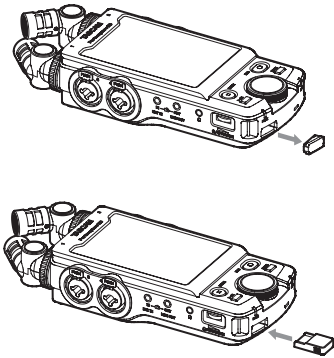

- Insert it so that the connector is toward the screen.

2. Enable Bluetooth connection on the smartphone or tablet.

NOTE

- Do not execute pairing from the Bluetooth device list screen of an iOS/iPadOS or Android device.
- Always launch Portacapture Control and use it for pairing.
- Refer to the operation manual of the Bluetooth device for procedures.

3. Use the smartphone or tablet to launch Portacapture Control.

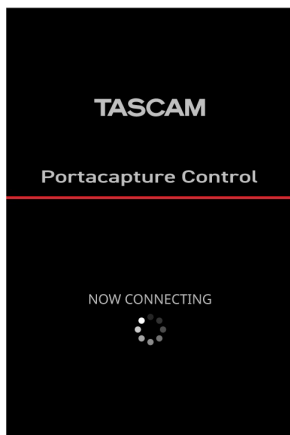

Bluetooth device screen

4. If the unit is not turned on, turn it on.
5. On the unit, turn the GENERAL SETTINGS screen > OTHER SETTINGS page > BLUETOOTH item on.

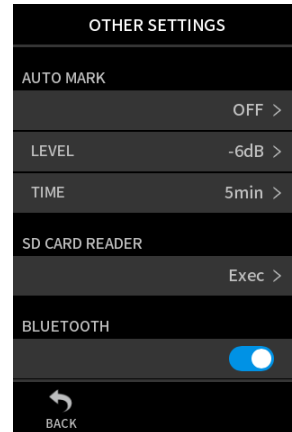

When connection completes, the display of the smartphone or tablet will automatically switch to the operation screen.

The AK-BT1 access indicator (blue) shows the connection status.

Indicator	Status
Unlit	Not paired
Blinking	Waiting to pair
Lit	Paired

14-3 Using the dedicated smartphone app

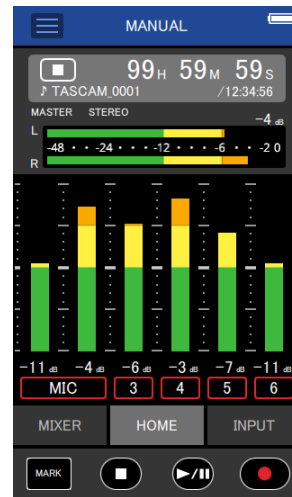

The four buttons at the bottom of the screen correspond to the physical buttons on the unit, and tapping them performs the same functions.

- MARK: MARK button
- : HOME [■] button
 - ▶/||: ▶/|| button
 - : REC [●] button

- Other operations are the same as using the touchscreen on the unit.

NOTE

Monitoring recording is not possible on paired devices. Use the headphone jack on the unit.

15-1 Adjusting gain differences between included mics (mic trim function)

Set this with the GENERAL SETTINGS screen > I/O SETTINGS page > MIC TRIM item.

This adjusts the sensitivity of the included mics.

Use this function to make adjustments when the volumes of the left and right included mics are noticeably different because the source cannot be recorded from the front or when the level difference between them is noticeable.

MIC L

Options: -3 dB, -2 dB, -1 dB, 0 dB (default value), 1 dB, 2 dB, 3 dB

MIC R

Options: -3 dB, -2 dB, -1 dB, 0 dB (default value), 1 dB, 2 dB, 3 dB

15-2 XRI function overview

This can be set using the GENERAL SETTINGS screen > SYSTEM page > XRI item.

When this is on, files recorded in WAV format will have recording setting information, including input volumes, saved in them as XRI (eXtended Recording Information) data.

- The XRI data recorded can be checked on the FILE INFORMATION screen. (page 62)

NOTE

XRI data cannot be saved when recording MP3 files.

15-3 Showing various information

Select the GENERAL SETTINGS screen > SYSTEM page > INFORMATION item.

CARD

This shows information about the microSD card.

SYSTEM

This shows the firmware and hardware versions.

15-4 Resetting the date and time

Select the GENERAL SETTINGS screen > SYSTEM page > DATE/TIME item, and adjust the settings. See "Setting the language, date and time" on page 20 for operation procedures.

15-5 Resetting the language

Select the GENERAL SETTINGS screen > SYSTEM page > LANGUAGE item, and adjust the setting.

15-6 Resetting the unit to its factory defaults.

Select the GENERAL SETTINGS screen > SYSTEM page > INITIALIZE item, and conduct initialization.

NOTE

After executing the INITIALIZE function, always use the ϕ /I/HOLD switch to turn the unit off.

15-7 Formatting microSD cards

Select the GENERAL SETTINGS screen > SYSTEM page > MEDIA FORMAT item, and conduct formatting. See "Formatting (initializing) microSD cards" on page 21 for operation procedures.

15-8 Using the automatic power saving function

This can be set using the GENERAL SETTINGS screen > POWER/DISPLAY page > AUTO POWER item.

When on, the unit automatically turns off after 30 minutes have elapsed since the last activity or operation.

NOTE

This function only works when the unit is stopped. This function will not cause the unit to turn off during recording or playback.

15-9 Selecting the power source

This can be set using the GENERAL SETTINGS screen > POWER/DISPLAY page > POWER SOURCE SELECT item.

BATTERY

Operate using battery power. Do not use USB power supply.

AUTO (DEFAULT)

Use USB power supply when available. When the power supply current is less than 500 mA, battery power will be used.

NOTE

When connecting this unit with an iOS device, set this to BATTERY.

CAUTION

Always put batteries in this unit before selecting BATTERY as the power source.

15-10 Setting the AA battery type (BATTERY)

This can be set using the GENERAL SETTINGS screen > POWER/DISPLAY page > BATTERY item.

Use this to set the type of battery used.

This setting is used to show the amount of remaining battery charge and determine if the unit has enough power for normal operation.

ALKALI

Alkaline batteries (default)

Ni-MH

Nickel-metal hydride batteries

LITHIUM

Lithium batteries

15 - Various settings

15-11 Power saving (energy conservation) mode

This can be set using the GENERAL SETTINGS screen > POWER/DISPLAY page > POWER SAVE MODE item.

POWER SAVE MODE

When this is on, the settings will become as follows, reducing power consumption.

BACKLIGHT: 30 sec

BRIGHTNESS: MID

INDICATORS: PEAK LED OFF

CONTRAST: 10

PHANTOM: All off (A pop-up message will not be shown.)

SAMPLE: Only 44.1/48kHz sampling frequencies can be selected (A pop-up message will not be shown.)

BACKLIGHT

This sets the display backlight.

OFF: Backlight always off

5–30 sec: Backlight turns off automatically after set time without operation

ALWAYS: Backlight always on

BRIGHTNESS

This sets the display brightness.

INDICATORS

This sets how the REC and PEAK indicators light.

ALL ON: Both REC LED and PEAK LED light.

PEAK LED OFF: The PEAK LED will not light.

ALL OFF: Both REC and PEAK LEDs will not light.

NOTE

- If an external power supply that provides current less than 1.5 A is connected, POWER SAVE MODE will be activated automatically. POWER SAVE MODE will not be turned off automatically. When switching to a power supply with 1.5 A current or higher, turn the POWER SAVE MODE off as necessary.
- When the POWER SAVE MODE setting is off, BACKLIGHT, BRIGHTNESS and INDICATORS settings can be made.

15-12 Adjusting the display contrast (CONTRAST)

This can be set using the GENERAL SETTINGS screen > POWER/DISPLAY page > CONTRAST item.

Slide the slider left and right to set the contrast between 0 and 20.

15-13 MENU

GENERAL SETTINGS

Category	Menu item	Settings	Reference	
REC SETTINGS	FILE FORMAT	WAV (default), MP3	page 48	
	WAV FILE FORMAT	SAMPLE		44.1kHz, 48kHz (default), 96kHz, 192kHz
		BIT DEPTH / BIT RATE		16bit, 24bit (default), 32-bit float
	MP3 FILE FORMAT	SAMPLE		44.1kHz, 48kHz (default)
		BIT DEPTH / BIT RATE	128Kbps, 192kbps, 256kbps, 320kbps (default)	
	REC PAUSE	OFF (default), ON	page 30	
	AUTO REC	OFF (default), ON	page 49	
	- START LEVEL	OFF, -6dB, -12dB (default), -24dB, -48dB		
	- END LEVEL	OFF, -6dB, -12dB, -24dB, -48 dB (default)		
	- END DELAY	1sec, 2sec, 3sec, 4sec, 5sec (default)		
	- END MODE	SAME FILE (default), NEW FILE		
	DUAL REC	OFF (default), MP3, FLOAT	page 49	
PRE REC	OFF (default), ON	page 49		
TIME FILE INCREMENT	OFF (default), 5 min, 10 min, 15 min, 30 min, 60 min	page 49		
I/O SETTINGS	PHANTOM	+24V, +48V (default)	page 29	
	MIC TRIM		page 73	
	- MIC L	-3dB, -2dB, -1dB, 0dB (default), 1dB, 2dB, 3dB		
	- MIC R	-3dB, -2dB, -1dB, 0dB (default), 1dB, 2dB, 3dB		
	SPEAKER	OFF (default), ON	page 25	
	MS DECODE	OFF, TRACK 1-2, TRACK 3-4, TRACK 5-6	page 70	
	REVERB	OFF (default), ON	page 7 page 29	
	- TYPE	LARGE HALL (default), SMALL HALL, ROOM, STUDIO, PLATE 1, PLATE 2		
	- SOURCE	TRACK 1-2, TRACK 3-4, TRACK 5-6, MIX (default)		
- LEVEL	0 - 50 (default) - 100			
CAMERA SETTINGS	OUTPUT	LINE (default), CAMERA	page 65	
	- LEVEL	-10 - 0 dB (default)		
	AUTO TONE	OFF (default), HEAD, HEAD + TAIL	page 65	
	- LEVEL	-12dB, -18dB (default), -24dB -30dB, -36dB		
OTHER SETTINGS	PEAK MARK	OFF (default), ON	page 64	
	AUTO MARK	OFF (default), LEVEL, TIME	page 64	
	- LEVEL	-6dB, -12dB (default), -24dB, -48dB		
	- TIME	5min, 10min, 15min, 30min, 60min (default)		
	SD CARD READER	Access microSD card in unit from computer	page 66	
	BLUETOOTH	OFF (default), ON	page 72	

15 - Various settings

Category	Menu item	Settings	Reference
SYSTEM	INFORMATION	FILE	page 73
		- FILE	
		- FORMAT	
		- DATE	
		- TIME	
		- TOTAL SIZE	
		TRACK	
		- TRACK 1, TRACK 2, TRACK 3, TRACK 4, TRACK 5, TRACK 6, MIX	
		CARD	
		- TOTAL FILE	
		- TOTAL FOLDER	
		- TOTAL SIZE	
		- USED SIZE	
		- REMAIN SIZE	
		SYSTEM	
	- F/W		
	- H/W		
XRI	OFF, ON (default)	page 73	
DATE / TIME	Set the date and time (yyyy/mm/dd HH:MM:SS)	page 73	
FILE NAME	- TYPE: DATE (default), WORD	page 56	
	- WORD EDIT: TASCAM (default)		
	- FILE No. RESET: OFF, ON (default)	page 56	
	- RESET		
LANGUAGE	ENGLISH (default), 日本語, FRANCAIS, ESPAÑOL, DEUTSCH, ITALIANO, 中文, 한글, русский язык	page 73	
INITIALIZE	EXECUTE	page 73	
MEDIA FORMAT	QUICK FORMAT, ERASE FORMAT	page 73	
POWER / DISPLAY	AUTO POWER SAVE	OFF, ON (default)	page 73
	BATTERY	ALKALI (default), Ni-MH, LITHIUM	page 73
	POWER SOURCE SELECT	BATTERY, AUTO (default)	page 73
	POWER SAVE MODE		page 74
	- BACKLIGHT	OFF, 5sec, 10sec, 15sec, 30sec, ALWAYS (default)	
	- BRIGHTNESS	LOW, MID (default), HIGH	
	- INDICATORS	ALL ON (default), PEAK LED OFF, REC LED OFF, ALL OFF	
	CONTRAST	0 – 10 (default) – 20	page 74

INPUT SETTINGS

Category	Menu item	Settings	Reference
INPUT GAIN	GAIN		page 29
	- MIC (1/2)	LOW (0dB - 36dB) / HIGH (14dB - 50dB) (in 0.5dB steps)	
	- MIC / LINE (3/4/5/6)	LOW (0dB - 35dB) / HIGH (22dB - 57dB) (in 0.5dB steps)	
	- EXT	0dB - 38dB (in 0.5dB steps)	
	- USB	-	
INPUT SETTINGS (for 1-6 each)	STEREO LINK	OFF (default), ON	page 27
	INPUT	MIC, LINE	page 27
	PHANTOM	OFF (default), ON	page 27
	AUTO GAIN	OFF (default), ON	page 27
	LOW CUT	OFF (default), 40Hz, 80Hz, 120Hz, 220Hz	page 28
	NOISE GATE	OFF (default), LOW, MID, HIGH	page 28
	LIMITER / COMP	OFF (default), LIMITER, COMPRESSOR	page 28
	EQ	OFF (default), VOICE, GUITAR, LOUD, VOCAL, MANUAL	page 28
PHASE INVERT	OFF (default), ON	page 29	

MIXER

Category	Menu item	Settings
MIXER	LEVEL	-inf - 0dB (default) (in 0.5dB steps)
	PAN	L20 - C - R20 When MS DECODE: ON WIDE: 0-50 (default) - 100
	Type of mix file (icon)	STEREO (default), MONO

BROWSE

Category	Menu item	Settings	Reference	
BROWSE	NEW FOLDER	RENAME	page 59	
FOLDER	OPEN	EXECUTE	page 58	
	RENAME	EXECUTE	page 59	
	ALL FILES DELETE	EXECUTE	page 59	
	FOLDER DELETE	EXECUTE	page 59	
FILE	SELECT	The selected file becomes the current project, and the app used for recording appears on the HOME screen.	page 60	
	PLAY	EXECUTE	page 60	
	FILE INFORMATION	FILE, TRACK appears	page 62	
	FILE DELETE	EXECUTE	page 62	
	TRACK DELETE	TRACK 1, TRACK 2, TRACK 3, TRACK 4, TRACK 5, TRACK 6, MIX	page 62	
	CHANGE PROTECT	EXECUTE	page 62	
	RENAME	EXECUTE	page 62	
	MARK	CLEAR ALL MARKS	page 62	
	DIVIDE	DIVIDE		page 63
		AUTO DIVIDE - ALL MARK		
AUTO DIVIDE - TIME MARK				
NORMALIZE	EXECUTE	page 63		

15 - Various settings

INPUT SELECT

Category	Menu item	Settings	Reference
INPUT SELECT	TRACK 1-2	1-2 (default), 3-4, 5-6, USB, EXT IN	page 26
	TRACK 3-4	1-2, 3-4 (default), 5-6, USB, EXT IN	
	TRACK 5-6	1-2, 3-4, 5-6 (default), USB, EXT IN	

LAUNCHER

Category	Menu item	Settings	Reference
ASMR	EXECUTE		page 33
MANUAL	EXECUTE		page 35
MUSIC	EXECUTE		page 38
VOICE	EXECUTE		page 40
FIELD	EXECUTE		page 42
PODCAST	EXECUTE		page 44
METRONOME	TEMPO	20 – 120 (default) – 250	page 69
	BEAT	1 – 4 (default) – 9	
	SOUND	CLICK (default), STICK, BELL	
	LEVEL	0 – 50 (default) – 100	
	START / STOP		
TUNER	MODE	CHROMATIC (default), OSCILLATOR	page 69
	SOURCE	MIC L (default), MIC R, IN 1, IN 2, IN 3, IN 4	
	CHROMATIC MODE	CALIB 435Hz – 440Hz (default) – 445Hz	
	OSCILLATOR MODE	NOTE C3 – A4 (default) – B5	
	LEVEL	0 – 50 (default) – 100	
	START / STOP		

The following is a list of pop-up messages.

Refer to this list if one of these pop-up messages appears on the Portacapture X8 and you want to check the meaning or determine a proper response.

Message	Details and response
Hold On	Buttons have been disabled by the HOLD switch.
No Card	Load a microSD card.
Card Error	The microSD card could not be recognized. Change the microSD card.
Card Full	The microSD card has no remaining capacity.
Format Error Format Card	The microSD card might not be formatted properly, or it might be broken. Tap the screen to start formatting. Formatting will erase all data on the microSD card.
Invalid Card Change Card	Something might be wrong with the microSD card. Change the microSD card.
MBR ERROR Init CARD	The microSD card might not be formatted properly, or it might be broken. Tap the screen to start formatting. Formatting will erase all data on the microSD card. If formatting is not possible, change the microSD card.
Write error REC continue	Writing to the microSD card timed out. This has caused audio to be interrupted and noise to occur. A BOF mark was added at the point when audio was interrupted.
Card slow Check BOF mark	microSD card writing performance has become worse. A BOF mark has been added at the point when audio was interrupted because writing to the microSD card timed out. Check the audio around the BOF mark. Execute the erase format function or change the microSD card.
Invalid SysFile Make Sys File	The system file required to operate this unit is invalid. Tap the screen to create a system file.
Non-Supported	See the Reference Manual for file formats that this unit can use.(see "Recording/playback formats" on page 82)
File Num Full	Recording is not possible because the total number of folders and files would exceed the limit of 5000.
File Not Found	The file was not found or might be damaged. Check the relevant file.
Can't delete File protected	Remove protection from a file before trying to delete it.
Can't divide File too short	The file is too short, so it cannot be divided.
Can't divide Current file MP3	MP3 files cannot be divided.
Can't divide No mark	Files that do not have marks cannot be divided with this function.
Can't divide Short interval	Mark division will not work when the interval between marks is two seconds or less.

Message	Details and response
Can't divide No file	There is no audio file.
Can't divide File name err	Division is not possible because the file name would exceed the limit of 200 characters. Use a computer to change the file name.
Can't delete Not empty	Folders that contain files cannot be deleted. Delete all the files in the folder and try again.
No XRI data	No XRI data has been saved in the file. Turn the XRI data recording function ON before starting recording. XRI data cannot be saved when recording MP3 files.
Can't MARK File Protected	Marks cannot be added because the file is protected from writing. Remove protection from a file to add marks to it.
Can't MARK File length	Marks cannot be added because the file is too short.
I/O Too Short	The IN and OUT points are too close together. Set them with at least 1 second between them.
Cannot Dual Rec Format	MP3 dual format recording cannot be used when the sampling frequency is 96 or 192 kHz.
File Error	If any of these errors occurs, turn the unit off and restart it.
Not Continued	If the unit cannot be turned off, remove the batteries, and disconnect the AC adapter (TASCAM PS-P520U, sold separately).
Player Error	
Writing Failed	If these error messages continue to appear frequently, please contact a TASCAM customer support service.
System Err XX (XX is a number)	
USB FS Mismatch	The sampling rates of the unit and the computer are not the same. Change the setting of one so that their sampling rates are the same.
Already used in other PAD	The same pad data cannot be used for two sound pads at the same time.
Battery is overheated. Change to USB power supply.	The internal temperature has become higher when using AA batteries. You can continue to use the unit by powering it with a USB connection.
Device is overheated. Turn off the power.	The internal temperature has become higher. The system will shut down automatically.

17 - Troubleshooting

If you are having trouble with the operation of this unit, please check the following before seeking repair. If these measures do not solve the problem, please contact the store where you purchased this unit or TASCAM customer support service.

Power will not turn on

- Confirm that the ϕ /I/HOLD switch is not set to HOLD.
- Confirm that batteries are installed correctly.
- Confirm that the TASCAM PS-P520U AC adapter (sold separately) power plug and the USB connector are securely connected. The unit might not operate properly through a USB hub.

The unit turns off automatically

- Confirm that the automatic power saving function is disabled.
 - The automatic power saving function can be turned on/off using the GENERAL SETTINGS screen > POWER/DISPLAY page > AUTO POWER SAVE item.
 - Since this unit complies with the European Standby Power Regulations (ErP), the automatic power saving function operates regardless of whether the unit is being powered by an AC adapter or batteries. If you do not want to use the automatic power saving function, set it to OFF. (The factory default setting is ON, which turns off the unit when it has not been used for 30 minutes.)

Operation is not possible using the unit controls

- Confirm that the ϕ /I/HOLD switch is not set to HOLD.
- Unit operations are not possible when SD CARD READER appears on the screen.

The microSD card is not recognized.

- Check that the microSD card is inserted correctly.
- Format it with a computer, and reinsert it.

No sound is output

- Confirm the unit's headphone/speaker output level.
- Check the monitoring system connections and volume level.
- No sound is output from the speaker under the following conditions.
 - The Ω / \square (headphone/speaker) volume is set to "0".
 - The GENERAL SETTINGS screen > I/O SETTINGS page > SPEAKER item set to Off. (see "Using the built-in speaker" on page 25)
 - The unit is recording or in recording standby
 - The LINE OUT or headphones jack is in use.

Recording is not possible

- Confirm that the microSD card has enough open space.
- Recording becomes impossible when the total number of files reaches 5000.

The input sound is extremely quiet or loud

- Check input level settings.(see "Adjusting input gain (GAIN)" on page 29)
- Check the output levels of connected equipment.

A file cannot be erased

- A protected (read only) file cannot be erased.

This unit's files do not appear on the computer.

- Confirm that the unit is properly connected to the computer through its USB port. The unit might not operate properly if connected through a USB hub.
- To show the unit's files on a computer, after connecting the unit to the computer using a USB cable, operation on the GENERAL SETTINGS screen is necessary. (see "Accessing microSD cards from a computer" on page 66)

The wrong language was set accidentally

- Slide the ϕ /I/HOLD switch toward the ϕ /I icon until the unit turns off. Then, while pressing the HOME [■] button, slide the ϕ /I/HOLD switch toward the ϕ /I icon again. The language selection menu will appear, and you will be able to select the language.

Noise is occurring

- If this unit is near a TV, radio, power amplifier or other device with a large transformer, noise could occur with this unit or other devices nearby.

The built-in speaker volume is low

- Turn the Ω / \square (headphone/speaker) volume in the direction that increases the number.
- If input levels were low during recording, it might be difficult to hear even when the speaker is at its maximum volume. If the maximum input level during recording is close to 0 dB, the built-in speaker will output at near maximum volume
- If more volume is needed, connect an external speaker with a built-in amp or an amp with a speaker connected to it.

The date/time is incorrect

- They can be set again using the GENERAL SETTINGS screen > SYSTEM page > DATE/TIME item.(see "Setting the date and time" on page 20)

The Shortcut Menu button is missing

- The Shortcut Menu button will not be shown during recording, recording standby, playback or when paused. Press the HOME [■] button to stop the unit.

A file is not recognized

- Recognizing files correctly becomes impossible when the total number of files exceeds 5000.
- Subfolders below the third level cannot be shown.
- This unit cannot show files that are not in the SOUND folder. (page 57)
- Files that are damaged cannot be shown correctly by this unit.

A file cannot be divided

- File division is not possible if it would create a file with a name that is the same as an existing file.
- File division is not possible if the file name would become more than 200 characters long.
- Mark division is not possible if it would create a file that is less than four seconds long.
- Manual file division is not possible if it would create a file that is less than two seconds long.

Batteries run out of power quickly

Try the following.

- Reduce the backlight time ("Power saving (energy conservation) mode" on page 74).
- Turn off all indicators ("Power saving (energy conservation) mode" on page 74).
- Reduce the brightness ("Power saving (energy conservation) mode" on page 74).
- Reduce the contrast ("Power saving (energy conservation) mode" on page 74).
- Turn the recording pause function on ("Recording app overview" on page 30).
- Lower the headphone/speaker volume.
- Disconnect input and output devices that are not in use.

The screen is dim

- Set BACKLIGHT to ALWAYS ("Power saving (energy conservation) mode" on page 74).

NOTE

The screen will always be dim when BACKLIGHT is set to OFF.

18 - Specifications

18-1 Specifications and rated values

Recorder specifications

Recording media

microSD cards (64 MB – 2 GB)
microSDHC cards (4 GB – 32 GB)
microSDXC cards (48 GB – 512 GB)

Recording/playback formats

WAV (BWF): 44.1/48/96/192kHz, 16/24-bit or 32-bit float
MP3: 44.1/48kHz, 128/192/256/320kbps

Number of channels

Input channels: 6 channels maximum
Recording tracks: 8 tracks maximum

Analog audio input ratings

Mic inputs (balanced)

Input jacks 3–6 (when set to MIC)

Connectors: XLR-3-31 equivalent(1: GND, 2: HOT, 3: COLD)
6.3mm (1/4") standard TRS jacks (Tip: HOT, Ring: COLD, Sleeve: GND)
(phantom power supported by XLR only)
Input impedance: 2.2 k Ω or higher
Maximum input level: +2 dBu
Minimum input level: –75 dBu

Input jacks 3–6 (when set to LINE)

Connectors: XLR-3-31 equivalent(1: GND, 2: HOT, 3: COLD)
6.3mm (1/4") standard TRS jacks
Input impedance: 9 k Ω or higher
Nominal input level: +4 dBu (GAIN setting at minimum)
Maximum input level: +24 dBu
Minimum input level: –53 dBu

Mic inputs (unbalanced): Input jacks 1–2 (support plug-in power)

Connectors: 3.5mm (1/8") TRS mini jacks
Input impedance: 85 k Ω or higher
Maximum input level: +1 dBV
Minimum input level: –69.3 dBV

Line input (unbalanced): EXT IN jack

Connector: 3.5mm (1/8") stereo mini jack
Input impedance: 8.5 k Ω or higher
Nominal input level: –10 dBV (GAIN setting at minimum)
Maximum input level: +10 dBV
Minimum input level: –48 dBV

Analog audio output

Line output (unbalanced): LINE OUT jack

Connector: 3.5mm (1/8") stereo mini jack
Output impedance: 200 Ω
Nominal output level: –14 dBV
Maximum output level: +6 dBV

- 0dBu=0.775Vrms
- 0dBV=1Vrms

Headphone output: headphone jack

Connector: 3.5mm (1/8") stereo mini jack
Maximum output: 45 mW + 45 mW (THD+N 0.1% or less, into 32 Ω load)

Built-in speaker

0.4 W (mono)

Control input/output ratings

USB port

Connector: Type-C
Format: USB 2.0 HIGH SPEED mass storage class

Bluetooth device connector

For Bluetooth adapter (AK-BT1) only

Audio performance

Frequency response

Input jacks 1–6 and EXT IN jack to PCM data
20 Hz – 20 kHz at 48 kHz: +0/–0.3 dB (JEITA)
20 Hz – 60 kHz at 192 kHz: +0/–2.5 dB (JEITA)

S/N ratio

Input jacks 1–2 to PCM data (20kHz SPCL LPF, A-weighting)
101dB (48 kHz)
Input jacks 3–6 and EXT IN jack to PCM data (20kHz SPCL LPF, A-weighting)
102dB (48 kHz)

Total harmonic distortion ratio (THD+N)

Input jacks 1–2 to PCM data (1kHz sine wave, –5 dBFS input, GAIN at minimum, 20kHz SPCL LPF)
0.005%
Input jacks 3–6 (LINE IN) to PCM data (1kHz sine wave, –5 dBFS input, GAIN at minimum, 20kHz SPCL LPF)
0.008%
Input jacks 3–6 (MIC IN) to PCM data (1kHz sine wave, –5 dBFS input, GAIN at minimum, 20kHz SPCL LPF)
0.006%

Note: JEITA indicates conformance to JEITA CP-2150

Recording times (in hours: minutes)

File format (recording setting)		Card capacity	
		32 GB (microSDHC)	128 GB (microSDXC)
320kbps MP3 (stereo)	44.1kHz	222:13	888:53
16-bit WAV (stereo)		50:23	201:33
24-bit WAV (stereo)	96kHz	15:25	61:43
24-bit WAV (stereo)	192kHz	7:42	30:51
32-bit float WAV (stereo)	192kHz	5:47	23:08

- The recording times shown above are estimates. They might differ depending on the microSD card in use.
- The recording times shown above are not continuous recording times, but rather they are the total possible recording times for the microSD card.
- If recorded in mono, maximum recording times will be about double those above.
- If using dual recording, maximum recording times will be about half those above.

Computer system requirements

Check the TEAC Global Site (<http://teac-global.com/>) for the latest information about supported operating systems. Operation with each OS was confirmed with standard system setups that met the following conditions. Operation is not guaranteed, however, with all systems that meet the following conditions.

Windows

Supported operating systems

Windows 10 64-Bit

Computer hardware requirements

Windows computer with a USB 2.0 (or higher)

*Operation is not guaranteed using the TASCAM driver with ARM64 CPUs.

Mac

Supported operating systems

macOS Big Sur (11)
macOS Catalina (10.15)

Computer hardware requirements

Mac with a USB 2.0 (or higher)

iOS/iPadOS devices

iOS 14/iPadOS 14
iOS 13/iPadOS 13

Android devices

Android 11
Android 10

*Compatibility has been confirmed, but this does not guarantee operation with all devices.

Other

Power

4 AA batteries (alkaline, NiMH or lithium-ion)
USB bus power from a computer
TASCAM PS-P520U AC adapter (sold separately)

Power consumption

7.5 W (maximum)

Battery operation time (continuous operation)

- Using alkaline batteries (EVOLTA)

Use conditions	Operation time
Input through input jacks 1–2 (included mics) Phantom power unused STEREO WAV (BWF)/44.1kHz 24-bit recording POWER SAVE MODE on	About 11:00
Input through input jacks 1/2 (included mics) and 5/6 Phantom power used (+48V, 3mA×2 load) STEREO WAV (BWF)/44.1kHz 24-bit recording POWER SAVE MODE on	About 5:30

- Using NiMH battery (eneloop)

Use conditions	Operation time
Input through input jacks 1–2 (included mics) Phantom power unused STEREO WAV (BWF)/44.1kHz 24-bit recording POWER SAVE MODE on	About 9:30
Input through input jacks 1/2 (included mics) and 5/6 Phantom power used (+48V, 3mA×2 load) STEREO WAV (BWF)/44.1kHz 24-bit recording POWER SAVE MODE on	About 5:30

- Using lithium-ion batteries (Energizer Ultimate Lithium)

Use conditions	Operation time
Input through input jacks 1–2 (included mics) Phantom power unused STEREO WAV (BWF)/44.1kHz 24-bit recording POWER SAVE MODE on	About 18:00
Input through input jacks 1/2 (included mics) and 5/6 Phantom power used (+48V, 3mA×2 load) STEREO WAV (BWF)/44.1kHz 24-bit recording POWER SAVE MODE on	About 10:00

NOTE

When using phantom power, the operation time might be reduced depending on the mic being used.

Dimensions

77 x 40 x 205.6 mm (width × height × depth, excluding protrusions)

Weight

472/381 g (with/without batteries)

Operating temperature range

0–40°C

- Illustrations in this manual might differ in part from the actual product.
- Specifications and external appearance might be changed without notification to improve the product.

18 - Specifications

18-2 Dimensional drawings

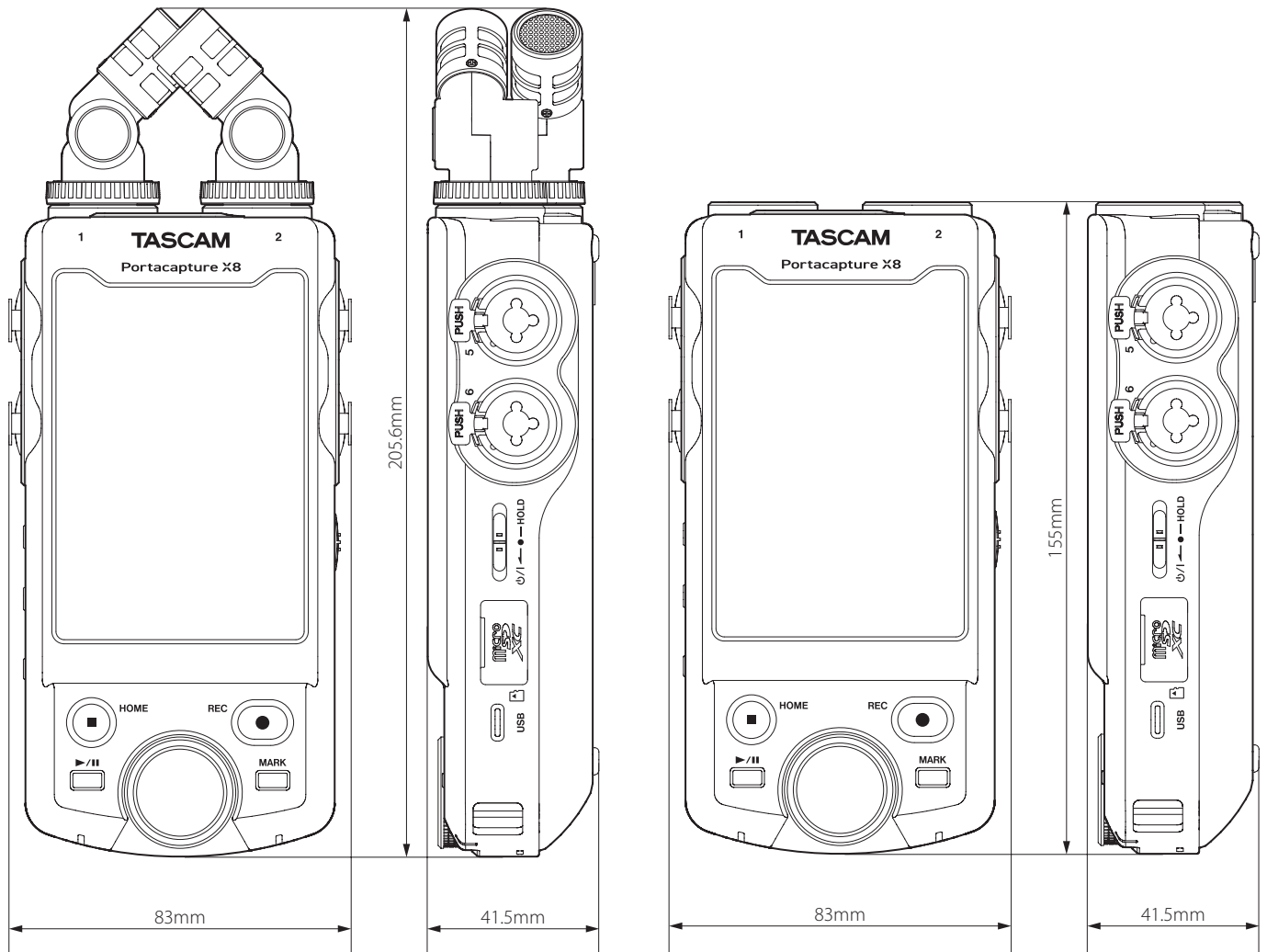

18-3 Block diagram

Portacapture X8
MIXER BLOCK DIAGRAM

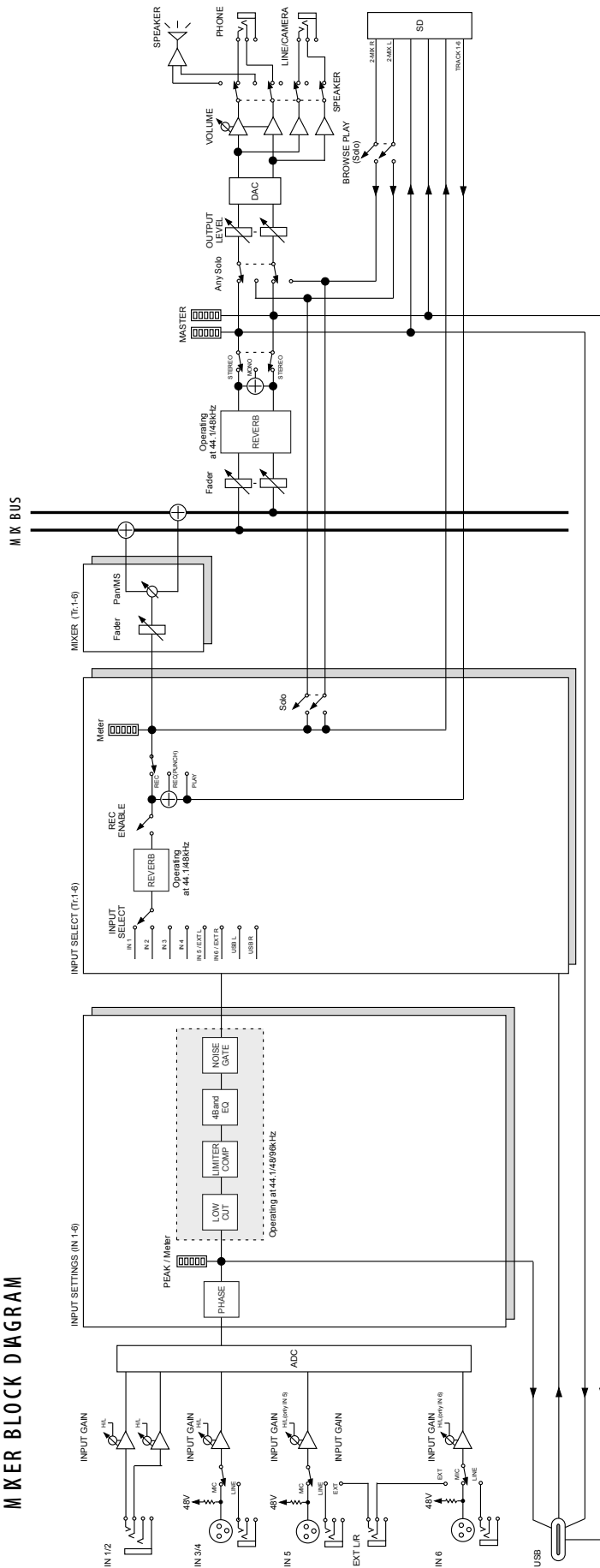

18-4 Level diagram

Portacapture X8 LEVEL DIAGRAM

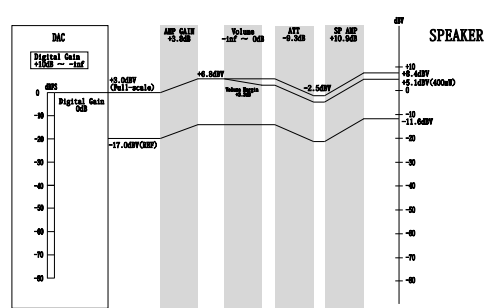
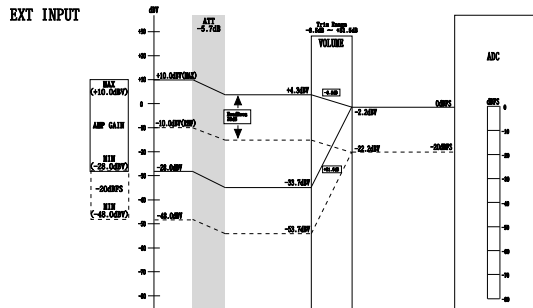
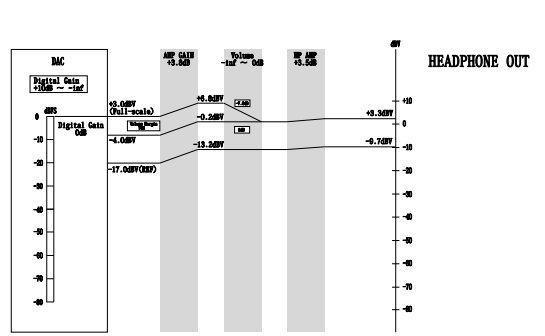
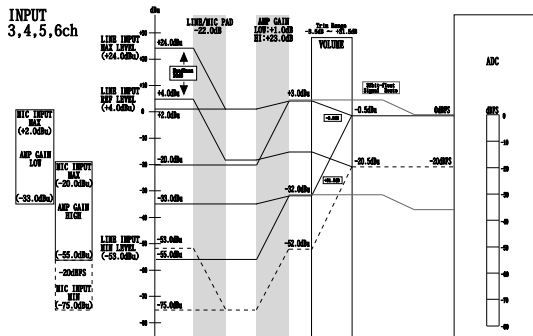
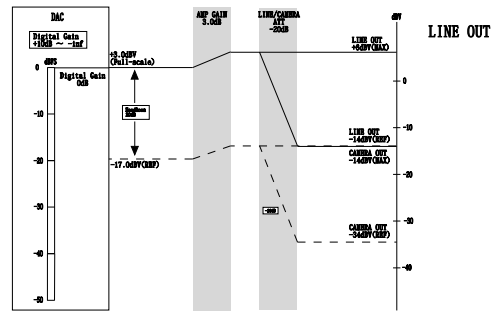
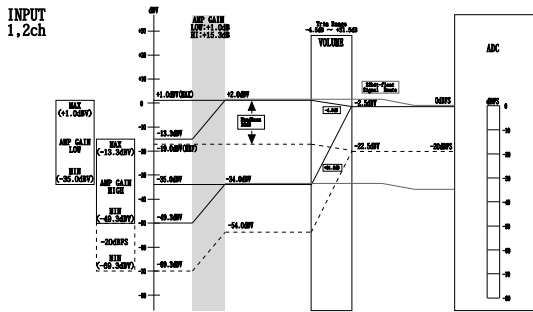

TASCAM

TEAC CORPORATION

<https://tascam.jp/jp/>

Phone: +81-42-356-9143
1-47 Ochiai, Tama-shi, Tokyo 206-8530 Japan

TEAC AMERICA, INC.

<https://tascam.com/us/>

Phone: +1-323-726-0303
10410 Pioneer Blvd. Suite #1, Santa Fe Springs, California 90670, U.S.A.

TEAC UK Ltd.

<https://www.tascam.eu/en/>

Phone: +44-1923-797205
Luminous House, 300 South Row, Milton Keynes, Buckinghamshire, MK9 2FR, United Kingdom

TEAC EUROPE GmbH

<https://www.tascam.eu/de/>

Phone: +49-611-71580
Bahnstrasse 12, 65205 Wiesbaden-Erbenheim, Germany

TEAC SALES & TRADING(SHENZHEN) CO., LTD

<https://tascam.cn/cn>

Phone: +86-755-88311561~2
Room 817, Xinian Center A, Tairan Nine Road West, Shennan Road, Futian District, Shenzhen, Guangdong Province 518040, China

1121.MA-3298B