

## Install Speakers

# AMS 6ICT LS-WH

6" ICT Surface-Mount Loudspeaker for Life Safety Installation Applications (White)

- Full range surface-mount loudspeaker for indoor and outdoor installation applications
- 60 Watts continuous, 240 Watts peak power
- 6" ICT (Inductive Coupling Technology) point source driver for extended frequency range and reliability
- 90° controlled conical dispersion for optimum coverage and forward gain
- High durability design for constant heavy usage in demanding applications
- UL 1480 UUMW certified for life safety applications
- UV and weather resistant UL 94 V-0 ABS enclosure
- Multiple transformer taps for 70 V and 100 V line systems or 16 Ohm direct input
- Low insertion loss 60 W line transformer with easily accessible tapping switch
- Optimised for LAB GRUPPEN low impedance LUCIA amplifiers with up to 8 AMS series loudspeakers per channel
- All components weather resistant to IP65 for outdoor use
- Semi matt white paint finish fits unobtrusively in any environment
- Yoke bracket included for ease of installation

The AMS 6ICT LS-WH is a full bandwidth 240-Watt high sensitivity loudspeaker that utilises our all-new proprietary 6" ICT (Inductive Coupling Technology) point source driver to deliver consistent broadband directivity and provide exceptional long-term reliability. Thanks to its extended frequency range and 90° controlled conical dispersion pattern, the AMS 6ICT LS-WH is ideally suited for indoor and outdoor music applications including theme parks, hotels, restaurants and bars, retail stores, as well as corporate AV, residential developments, and houses of worship.



### UL 1480 UUMW Certification

Designed to provide the same high-quality audio performance as our AMS 6ICT-WH Surface-Mount Loudspeaker, the AMS 6ICT LS-WH meets the demanding requirements of UL 1480 UUMW for use in fire alarm and/or emergency communication system applications.

## Install Speakers

# AMS 6ICT LS-WH

6" ICT Surface-Mount Loudspeaker for Life Safety Installation Applications (White)

- Optional VARIBALL multi-angle bracket with secure clamp mechanism for accurate audience coverage
- Weatherproof cable gland cover to protect Phoenix\* connectors and tap selector switch
- 10-Year Warranty Program\*
- Designed and engineered in the U.K.

## Weather-Resistant Enclosure

The elegantly styled semi matt black moulded enclosure blends beautifully into any décor. Additionally the AMS 6ICT LS-WH's design and performance has achieving an IP65 rating, making it an exceptional choice for both indoor and outdoor environments such as indoor swimming pools, saunas, or work areas with unusually high levels of dust or moisture, and outdoor applications where weather conditions are moderate.

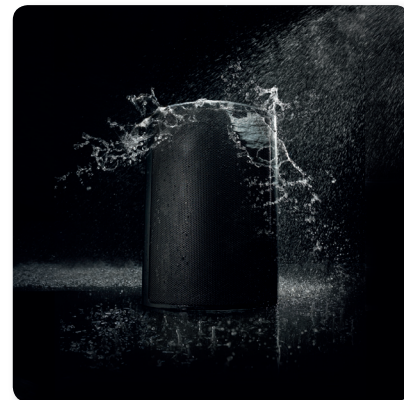

## Attractive and Easy to Install

The highly durable and heat resistant ABS enclosure features a white painted finish and comes with an aesthetically pleasing grille. Installation is quick and easy thanks to the included colour-matched yoke mounting bracket – and an optional VARIBALL multi-angle bracket is available separately. An included weatherproof cable gland protects the Phoenix\* input and link output connectors, as well as the integral low-insertion loss 60 W transformer with convenient tap switching.

\*All third-party trademarks are the property of their respective owners. Their use neither constitutes a claim of the trademark nor affiliation of the trademark owners with MUSIC Group. Product names are mentioned solely as a reference for compatibility, effects and/or components. Warranty details can be found at [music-group.com](http://music-group.com).

## Install Speakers

# AMS 6ICT LS-WH

6" ICT Surface-Mount Loudspeaker for  
Life Safety Installation Applications (White)

### LAB GRUPPEN Ready

The AMS 6ICT LS-WH is optimised for use with LAB GRUPPEN LUCIA amplifiers, which accommodate up to 8 AMS Series loudspeakers per channel.



### You Are Covered

We always strive to provide the best possible Customer Experience. Our products are made in our own MUSIC Tribe factory using state-of-the-art automation, enhanced production workflows and quality assurance labs with the most sophisticated test equipment available in the world. As a result, we have one of the lowest product failure rates in the industry, and we confidently back it up with a generous Warranty program.

## Install Speakers

# AMS 6ICT LS-WH

6" ICT Surface-Mount Loudspeaker for Life Safety Installation Applications (White)

### Frequency Response Sensitivity 1 W / 1 m

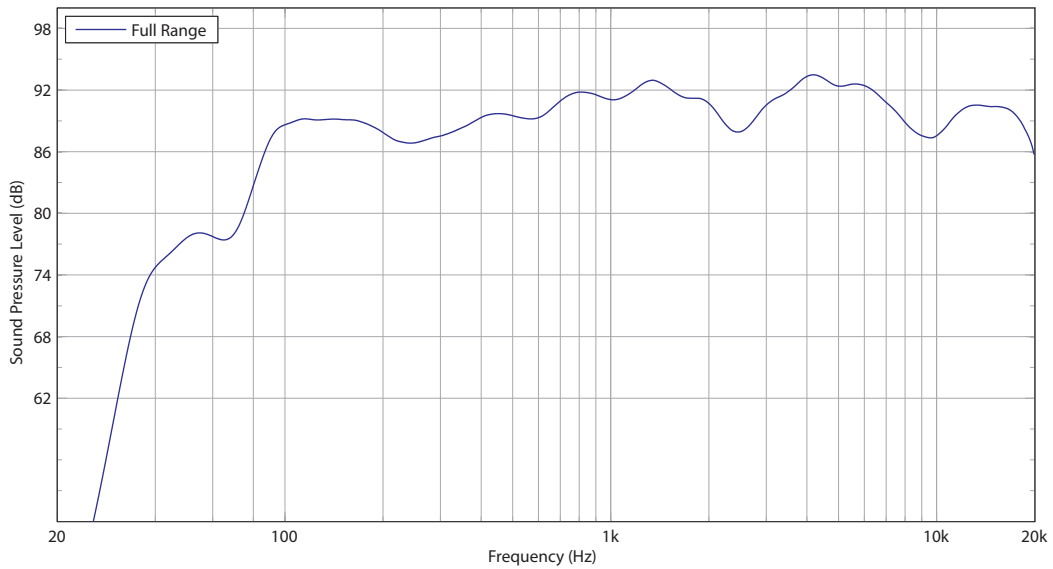

### Impedance

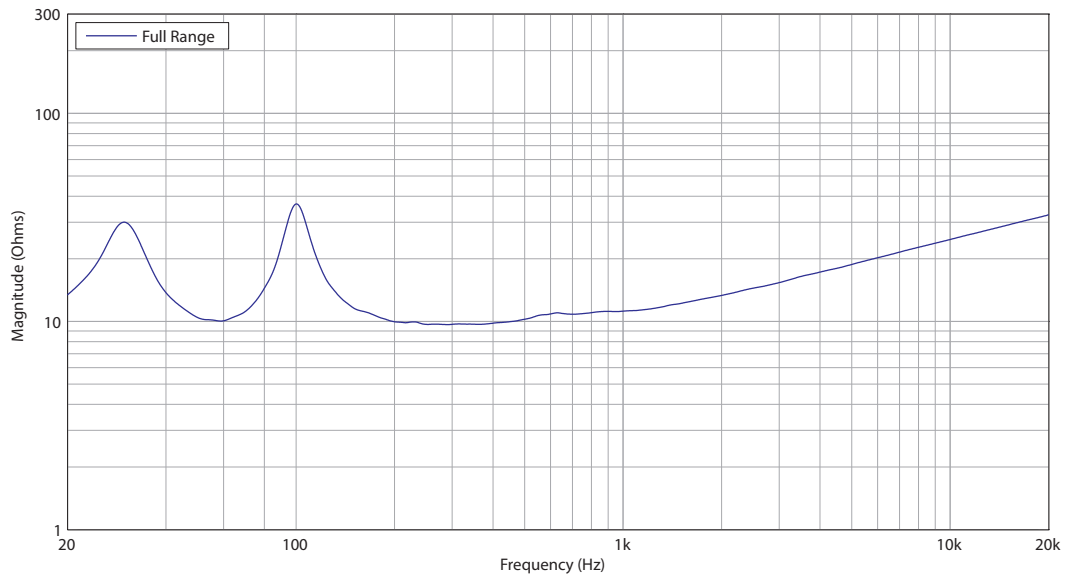

## Install Speakers

# AMS 6ICT LS-WH

6" ICT Surface-Mount Loudspeaker for Life Safety Installation Applications (White)

### Horizontal Beamwidth

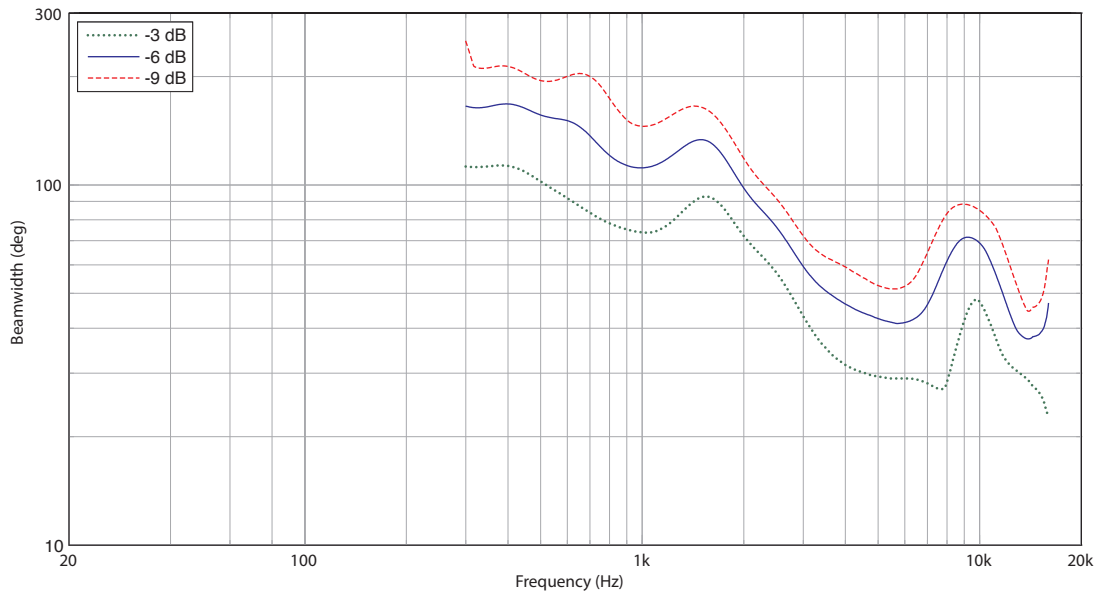

### Vertical Beamwidth

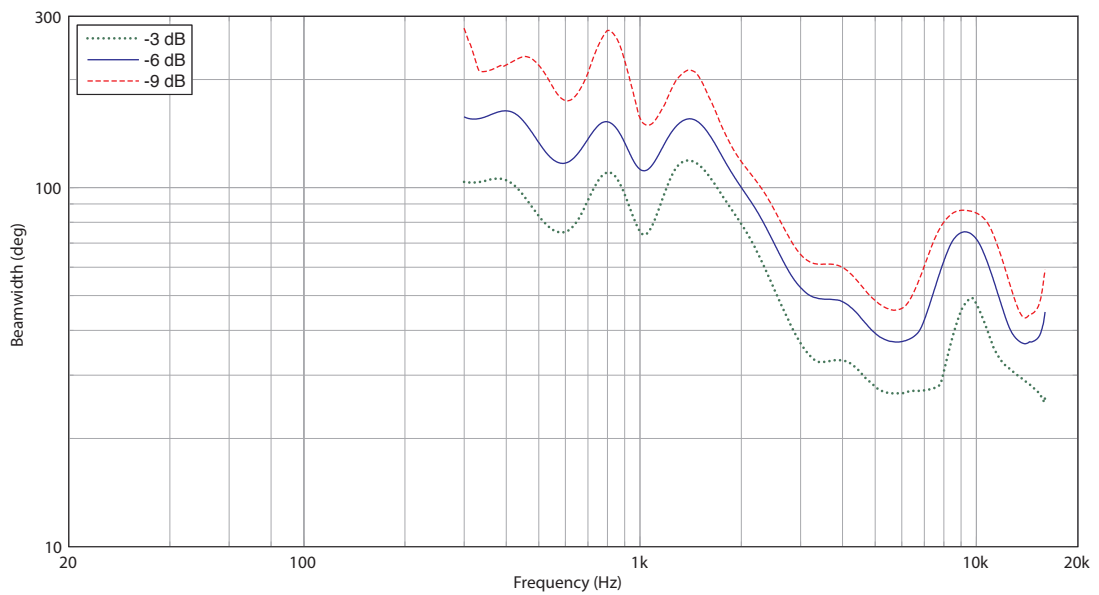

## Install Speakers

# AMS 6ICT LS-WH

6" ICT Surface-Mount Loudspeaker for Life Safety Installation Applications (White)

## Horizontal Polar Plots

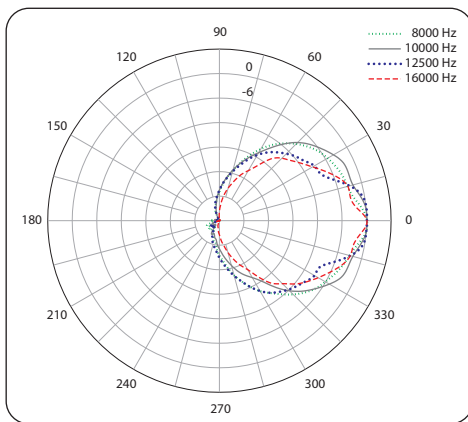
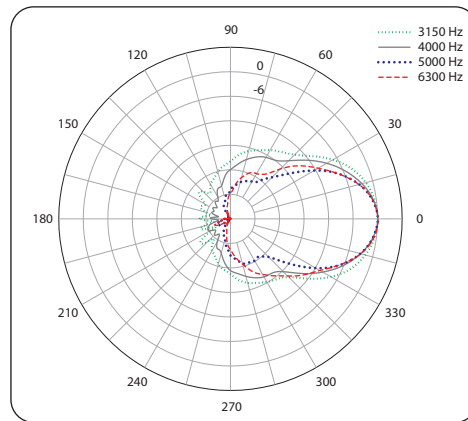
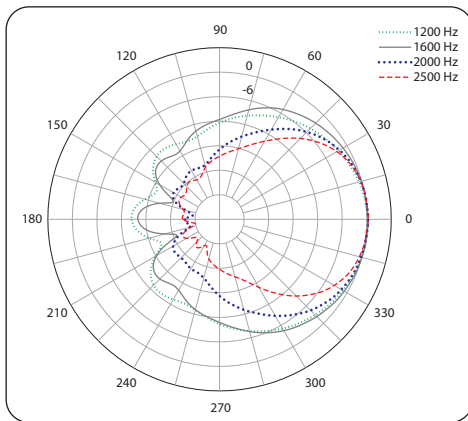
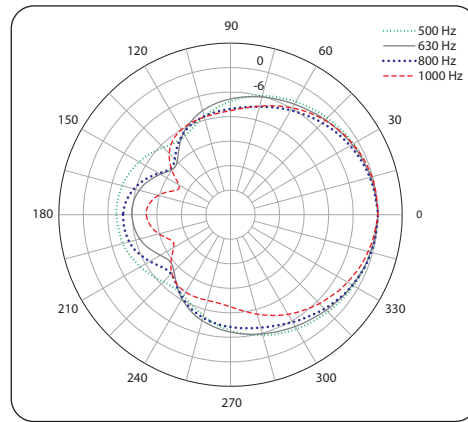
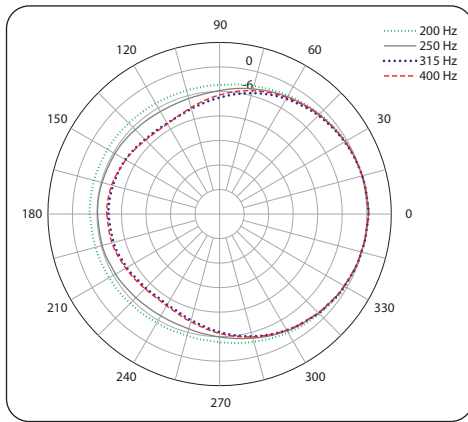

## Install Speakers

# AMS 6ICT LS-WH

6" ICT Surface-Mount Loudspeaker for Life Safety Installation Applications (White)

### Vertical Polar Plots

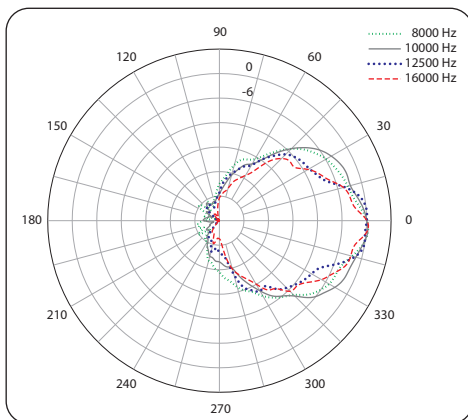
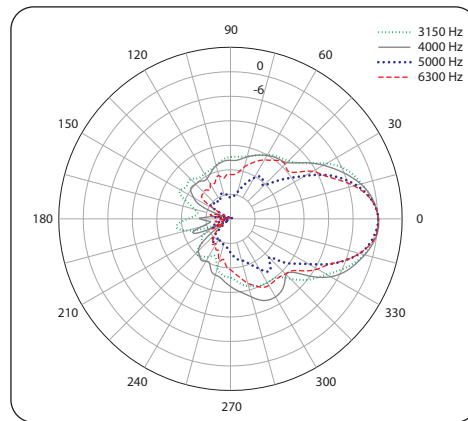
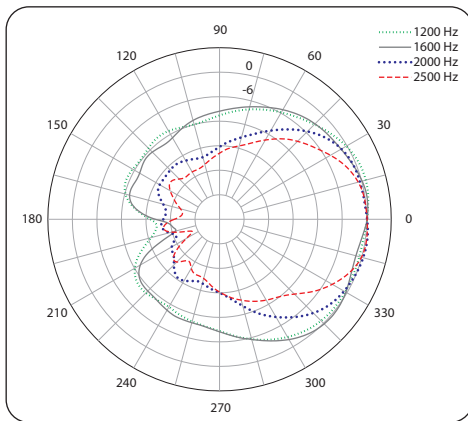
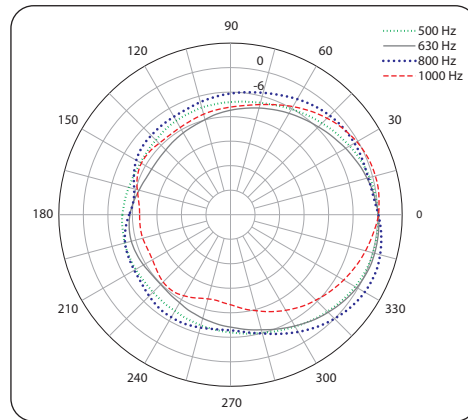
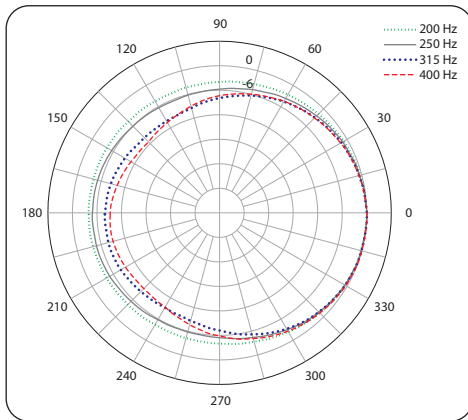

## Install Speakers

# AMS 6ICT LS-WH

6" ICT Surface-Mount Loudspeaker for Life Safety Installation Applications (White)

## Dimensions

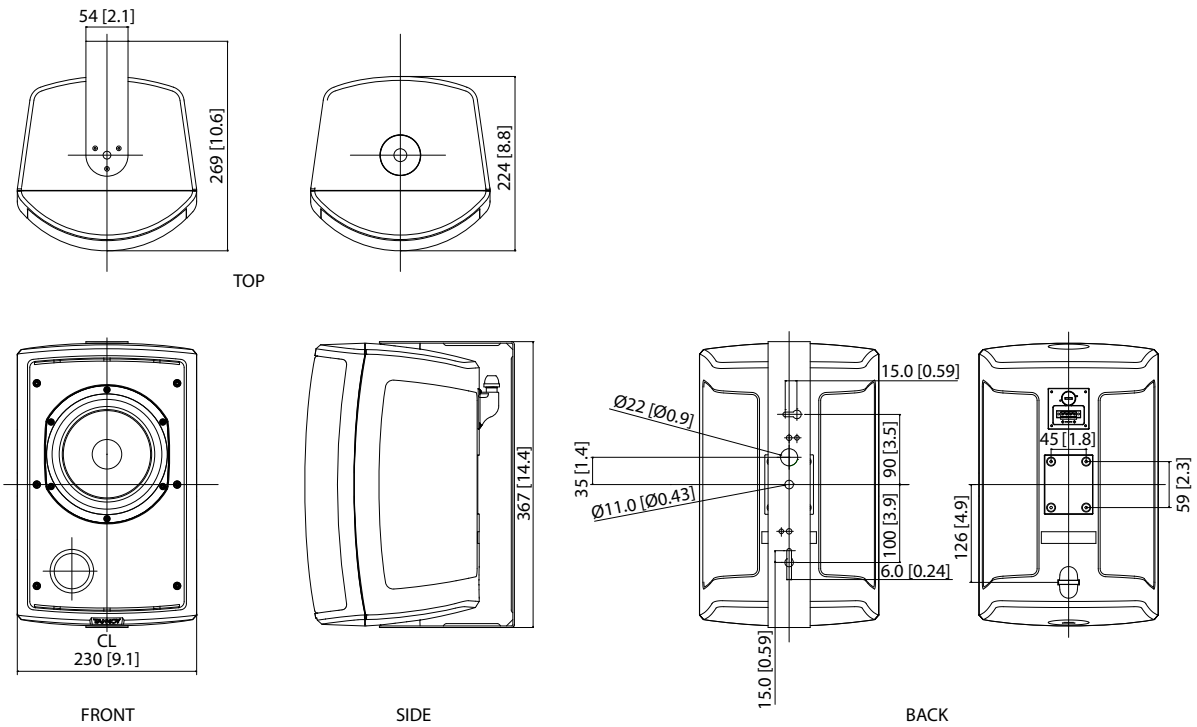



## Install Speakers

# AMS 6ICT LS-WH

6" ICT Surface-Mount Loudspeaker for  
Life Safety Installation Applications (White)

## Technical Specifications

### Performance

<b>Frequency response (-3 dB) <sup>(1)</sup></b>	75 Hz - 30 kHz
<b>Frequency range (-10 dB) <sup>(1)</sup></b>	55 Hz - 30 kHz
<b>System sensitivity (1 W @ 1m) <sup>(2)</sup></b>	90 dB (1 W = 4 V for 16 ohms)
<b>Nominal Coverage Angle</b>	90 degrees conical
<b>Power Handling <sup>(3)</sup></b>	
Average	60 W
Programme	120 W
Peak	240 W
<b>Recommended Amplifier Power</b>	120 W @ 16 ohms
<b>Nominal Impedance (Lo, Z)</b>	16 ohms
<b>Rated maximum SPL</b>	
Average	108 dB
Peak	114 dB
<b>Transformer Taps</b> (via front rotary switch)	
70 V	60 W / 30 W / 15 W / 7.5 W / OFF & Low impedance operation
100 V	60 W / 30 W / 15 W / OFF & Low impedance operation

### Transducers

<b>Low Frequency</b>	1 x 165 mm (6.50") treated multi fibre paper pulp cone
<b>High Frequency</b>	ICT

### Physical

<b>Enclosure</b>	ABS
<b>Grille</b>	Steel, plated and painted
<b>Connectors</b>	Removable locking connector with screw terminals
<b>Transformer setting</b>	Rotary switch
<b>Dimensions (H x W x D)</b>	364.8 x 230.0 x 268.8 mm (14.36 x 9.05 x 10.58")
<b>Net Weight (ea)</b>	5.4 kg (11.90 lbs)
<b>Shipped weight</b>	6.25 kg (13.77 lbs)
<b>Included Accessories</b>	Yoke bracket
<b>Packed Quantity</b>	2

Install Speakers

# AMS 6ICT LS-WH

6" ICT Surface-Mount Loudspeaker for  
Life Safety Installation Applications (White)



Install Speakers

# AMS 6ICT LS-WH

6" ICT Surface-Mount Loudspeaker for  
Life Safety Installation Applications (White)



Install Speakers

# AMS 6ICT LS-WH

6" ICT Surface-Mount Loudspeaker for  
Life Safety Installation Applications (White)

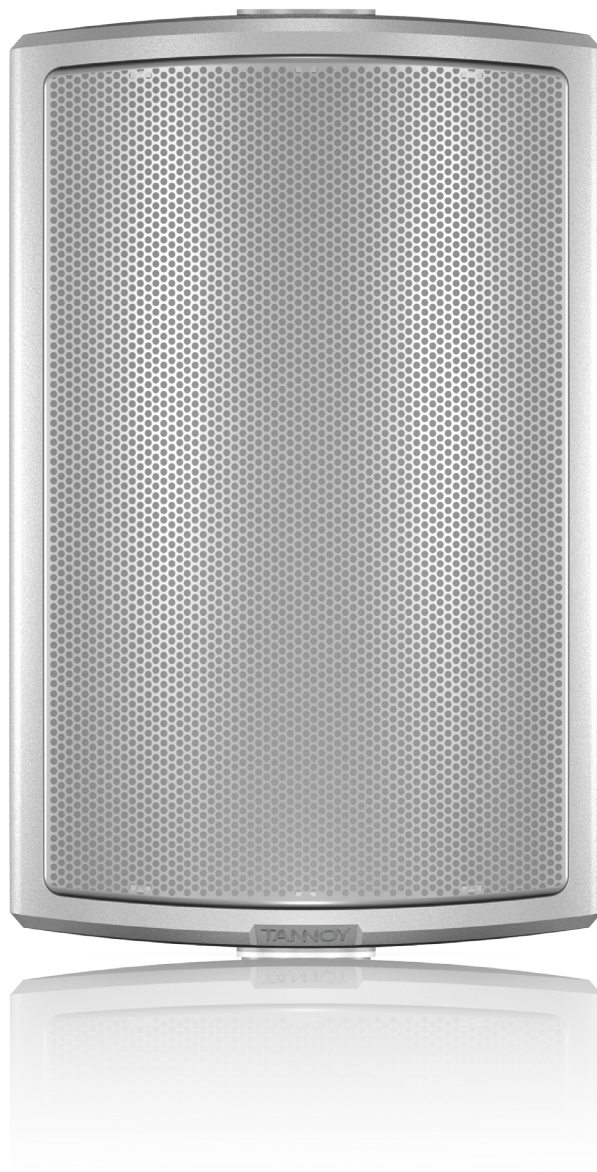

Install Speakers

# AMS 6ICT LS-WH

6" ICT Surface-Mount Loudspeaker for  
Life Safety Installation Applications (White)



Install Speakers



# AMS 6ICT LS-WH

6" ICT Surface-Mount Loudspeaker for Life Safety Installation Applications (White)

SUSPENDING THIS SYSTEM SHOULD ONLY BE DONE BY QUALIFIED PERSONS FOLLOWING SAFE INSTALLATION STANDARDS

SUITABLE FOR USE IN INDOOR, DRY AND OUTDOOR, WET LOCATIONS

**SIGNALING**  
 Type: F, G  
 US 3PHS

MADE IN CHINA  
  

**SPEAKER: AMS 6ICT LS**

INPUT	POWER	SND PRESSURE AT 10FT.++	WIRING	PASSIVE
70 V LINE	7.5, 15, 30, 60 W	87.1, 89.8, 91.7, 94.1 dB (A)	1+ / 2-	INPUT
100 V LINE	15, 30, 60 W	90.3, 92.3, 94.6 dB (A)	3- / 4+	LINK
16 Ω	120 W PROGRAM	N/A	N/A	N/A

REFER TO INSTALLATION WIRING DIAGRAM IN QUICK START GUIDE

**TANNOY**  
 DESIGNED AND ENGINEERED IN THE U.K.



For service, support or more information contact the TANNOY location nearest you:

**Europe**  
**MUSIC Tribe Brands UK Ltd.**  
 Tel: +44156 273 2290  
 Email: CARECrea@music-group.com  
 CAREEnte@music-group.com  
 CARELife@music-group.com

**USA/Canada**  
**MUSIC Tribe Commercial NV Inc.**  
 Tel: +1 702 800 8290  
 Email: CARECrea@music-group.com  
 CAREEnte@music-group.com  
 CARELife@music-group.com

**Japan**  
**MUSIC Tribe Services JP K.K.**  
 Tel: +81 3 6231 0453  
 Email: CARECrea@music-group.com  
 CAREEnte@music-group.com  
 CARELife@music-group.com

MUSIC Tribe accepts no liability for any loss which may be suffered by any person who relies either wholly or in part upon any description, photograph, or statement contained herein. Technical specifications, appearances and other information are subject to change without notice. All trademarks are the property of their respective owners. MIDAS, KLARK TEKNIK, LAB GRUPPEN, LAKE, TANNNOY, TURBOSOUND, TC ELECTRONIC, TC HELICON, BEHRINGER, BUGERA and COOLAUDIO are trademarks or registered trademarks of MUSIC Group IP Ltd. © MUSIC Group IP Ltd. 2018 All rights reserved.

