

## Install

# AMS 6DC

6" Dual Concentric Surface-Mount Loudspeaker for Installation Applications

- Full range surface-mount loudspeaker for indoor and outdoor installation applications
- 80 Watts continuous, 320 Watts peak power
- 6" next generation Dual Concentric driver featuring Omnimagnet technology
- Torus Ogive waveguide for improved high frequency response and directivity
- Multiple transformer taps for 70 V and 100 V line systems or 16 Ohm direct input
- Low insertion loss 60 W line transformer with easily accessible tapping switch
- Optimised for LAB GRUPPEN low impedance LUCIA amplifiers with up to 8 AMS series loudspeakers per channel
- All components weather resistant to IP65 for outdoor use
- High temperature resistant ABS enclosure rated at 120°C
- Semi matt black paint finish fits unobtrusively in any environment
- Yoke bracket included for ease of installation
- Optional VARIBALL multi-angle bracket with secure clamp mechanism for accurate audience coverage

The AMS 6DC is a full bandwidth 320-Watt high sensitivity loudspeaker that utilises our all-new proprietary 6" Dual Concentric point-source driver with Omnimagnet technology on a Torus Ogive Waveguide to deliver wide and consistent broadband directivity with enhanced intelligibility – plus the linear response of our legendary studio monitors. The AMS 6DC is ideally suited for stereo or mono background/foreground music applications in theme parks, hotels, restaurants and bars, retail stores, as well as corporate AV, residential developments, and houses of worship. AMS 6DC loudspeakers provide a seamless sound signature within a multi-zoned environment that benefits from both ceiling and wall mounted **TANNOY** loudspeakers.



### Weather-Resistant Enclosure

The elegantly styled semi matt black moulded enclosure blends beautifully into any décor. Additionally the AMS 6DC's design and performance has achieving an IP65 rating, making it an exceptional choice for both indoor and outdoor environments such as indoor swimming pools, saunas, or work areas with unusually high levels of dust or moisture, and outdoor applications where weather conditions are moderate.

## Install

# AMS 6DC

6" Dual Concentric Surface-Mount  
Loudspeaker for Installation Applications

- Weatherproof cable gland cover to protect Phoenix\* connectors and tap selector switch
- 10-Year Warranty Program\*
- Designed and engineered in the U.K.

## Attractive and Easy to Install

The highly durable and heat resistant ABS enclosure features a black painted finish and comes with an aesthetically pleasing grille. Installation is quick and easy thanks to the included colour-matched yoke mounting bracket – and an optional VARIBALL multi-angle bracket is available separately. An included weatherproof cable gland protects the Phoenix\* input and link output connectors, as well as the integral low-insertion loss 60 W transformer with convenient tap switching.



## LAB GRUPPEN Ready

The AMS 6DC is optimised for use with LAB GRUPPEN LUCIA amplifiers, which accommodate up to 8 AMS Series loudspeakers per channel.



## Install

# AMS 6DC

6" Dual Concentric Surface-Mount  
Loudspeaker for Installation Applications

## You Are Covered

We always strive to provide the best possible Customer Experience. Our products are made in our own [MUSIC Tribe](#) factory using state-of-the-art automation, enhanced production workflows and quality assurance labs with the most sophisticated test equipment available in the world. As a result, we have one of the lowest product failure rates in the industry, and we confidently back it up with a generous [Warranty program](#).



Install

# AMS 6DC

6" Dual Concentric Surface-Mount  
Loudspeaker for Installation Applications

## Frequency Response Sensitivity 1 W / 1 m

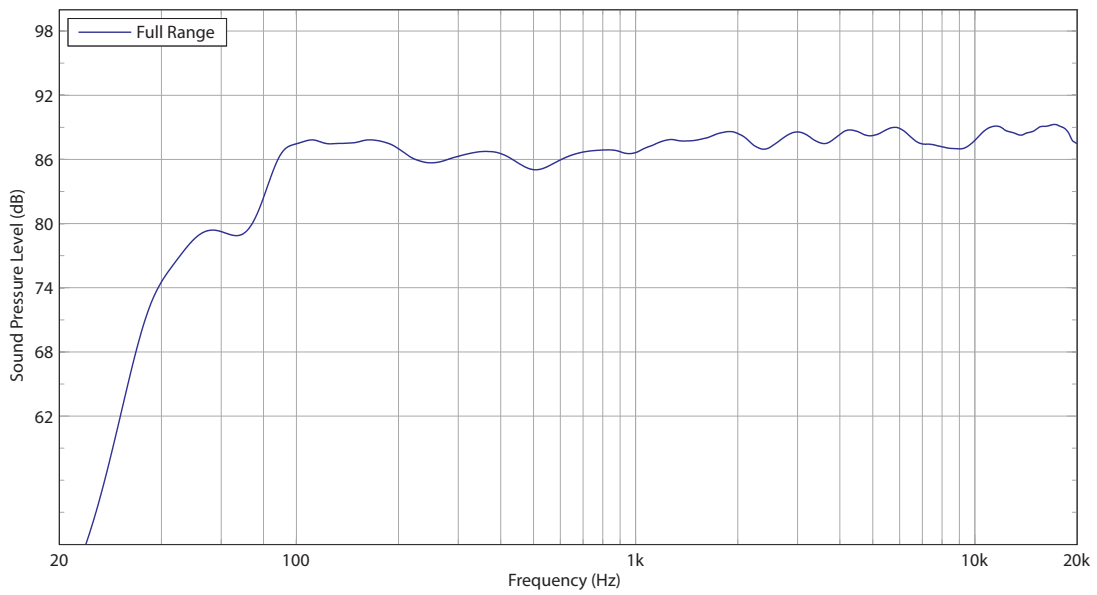

## Impedance

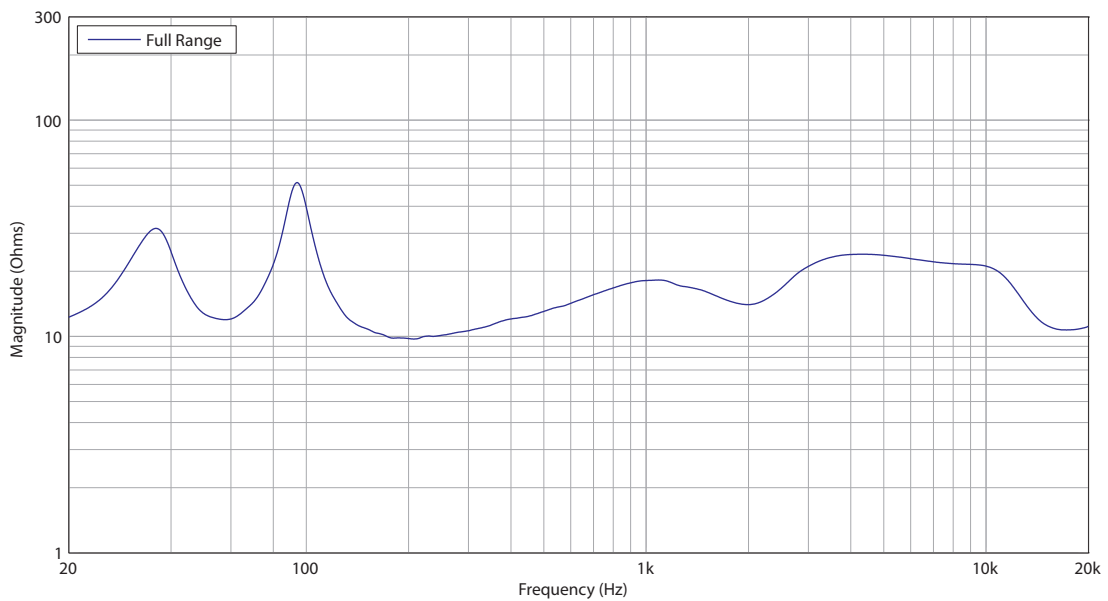

# AMS 6DC

6" Dual Concentric Surface-Mount  
Loudspeaker for Installation Applications

## Horizontal Beamwidth

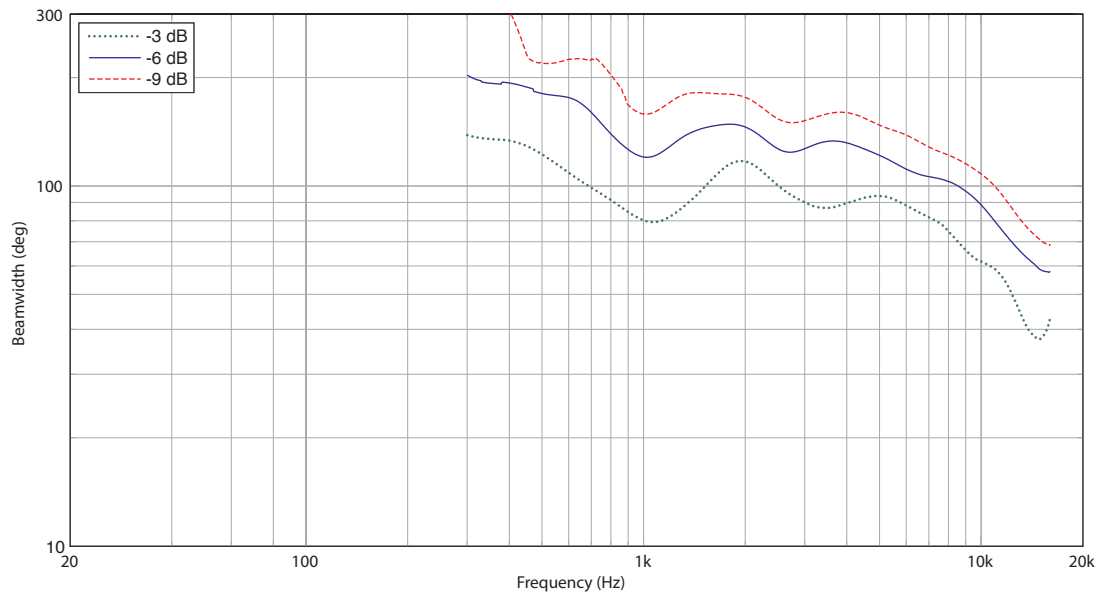

## Vertical Beamwidth

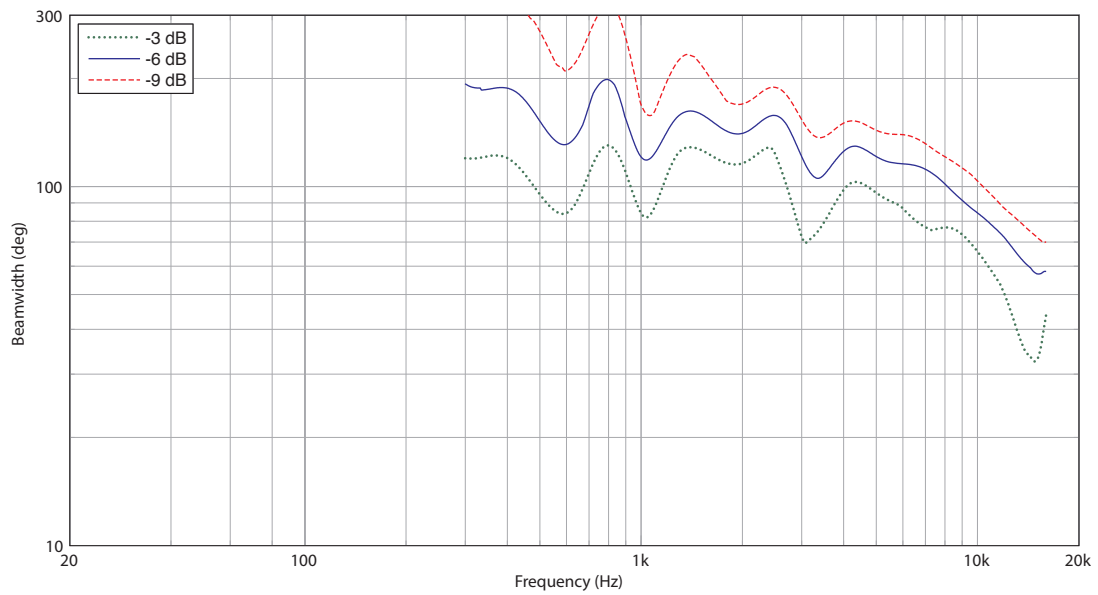

Install

# AMS 6DC

6" Dual Concentric Surface-Mount Loudspeaker for Installation Applications

## Horizontal Polar Plots

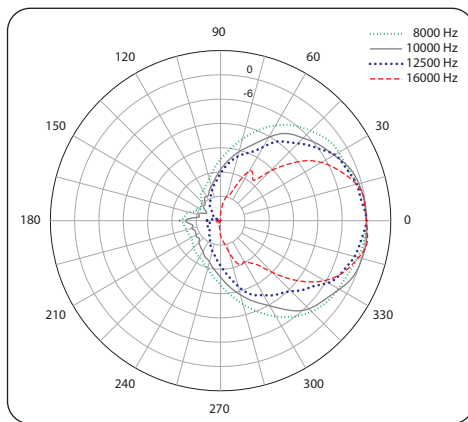
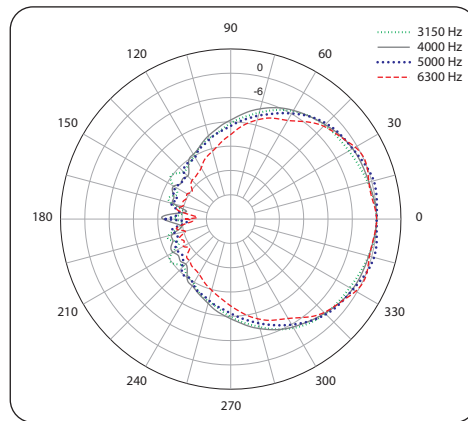
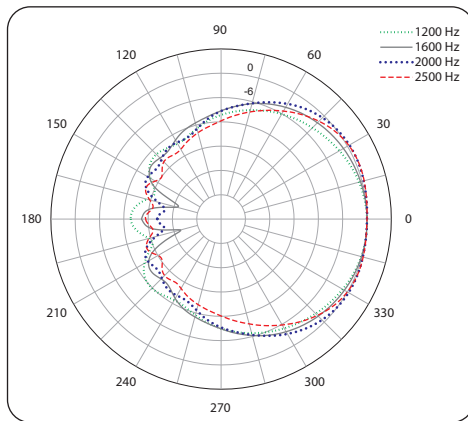
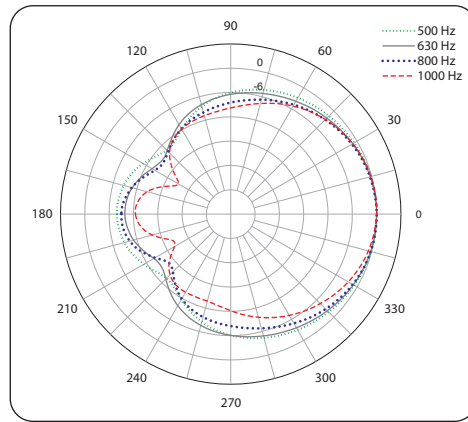
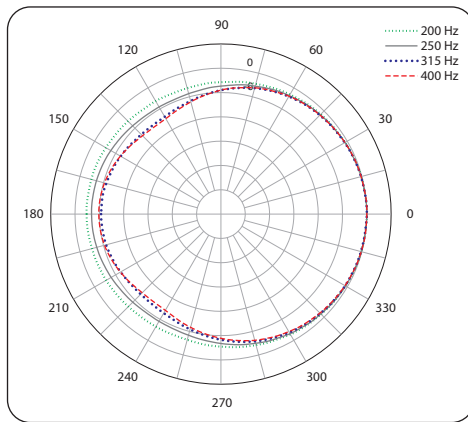

# AMS 6DC

6" Dual Concentric Surface-Mount Loudspeaker for Installation Applications

## Vertical Polar Plots

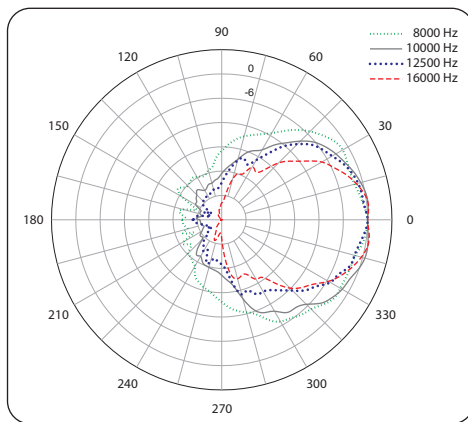
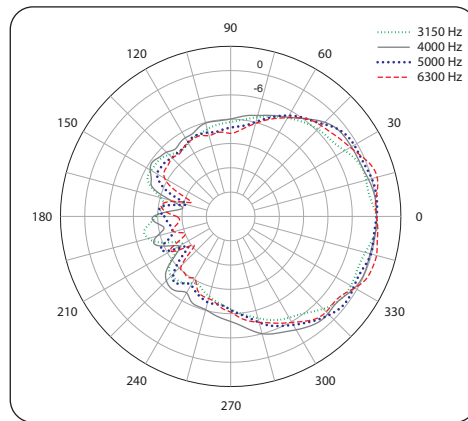
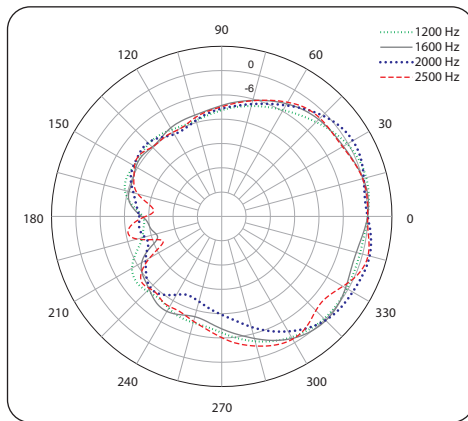
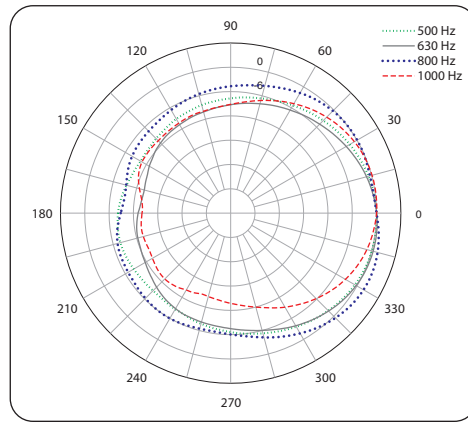
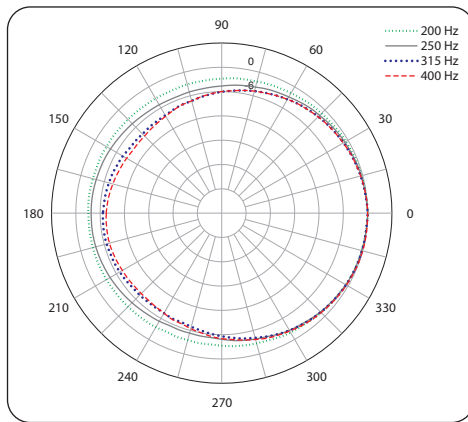

Install

# AMS 6DC

6" Dual Concentric Surface-Mount Loudspeaker for Installation Applications

## Dimensions

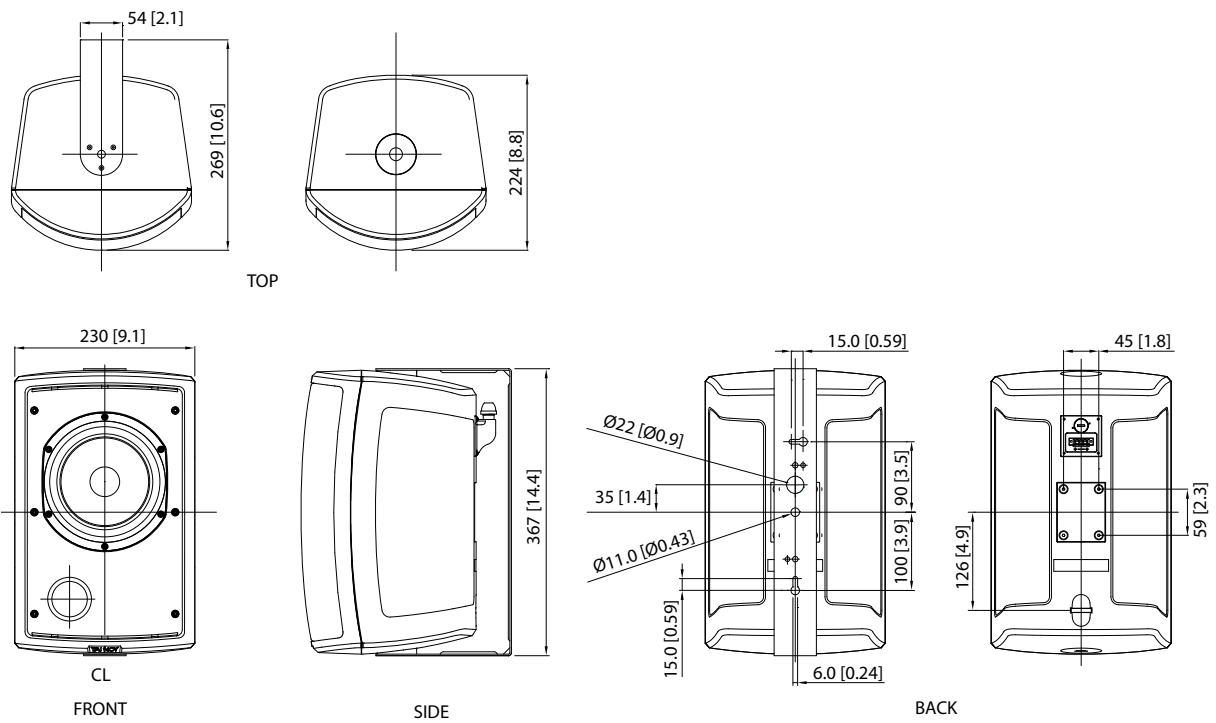



## Install

# AMS 6DC

6" Dual Concentric Surface-Mount  
Loudspeaker for Installation Applications

## Technical Specifications

### Performance

Frequency response (-3 dB) <sup>(1)</sup>	75 Hz - 30 kHz
Frequency range (-10 dB) <sup>(1)</sup>	55 Hz - 40 kHz
System sensitivity (1 W @ 1m) <sup>(2)</sup>	89 dB (1 W = 4 V for 16 Ω)
Nominal Coverage Angle	90 degrees conical
<b>Power Handling</b> <sup>(3)</sup>	
Average	80 W
Programme	160 W
Peak	320 W
Recommended Amplifier Power	160 W @ 16 Ω
Nominal Impedance (Lo, Z)	16 Ω
<b>Rated maximum SPL</b>	
Average	108 dB
Peak	114 dB
<b>Transformer Taps</b> (via front rotary switch)	
70 V	60 W / 30 W / 15 W / 7.5 W / OFF & Low impedance operation
100 V	60 W / 30 W / 15 W / OFF & Low impedance operation

### Transducers

Dual Concentric point source driver	1x 165 mm (6.50") Dual Concentric driver, using Omnimagnet technology
Low Frequency	44 mm (1.75" ) voice coil, treated multi fibre paper pulp cone
High Frequency	25 mm (1") PEI dome

### Physical

Enclosure	ABS
Grille	Steel, plated and painted
Connectors	Removable locking connector with screw terminals
Transformer setting	Rotary switch
Dimensions (H x W x D)	364.8 x 230.0 x 268.8 mm (14.36 x 9.05 x 10.58")
Net Weight (ea)	6.25 kg (13.78 lbs)
Shipped weight	7.1 kg (15.6 lbs)
Included Accessories	Yoke bracket
Packed Quantity	2

#### Notes:

1. Average over stated bandwidth. Measured in an IEC baffle in an Anechoic Chamber
2. Unweighted pink noise input, measured at 1 metre on axis
3. Long term power handling capacity as defined in EIA - 426B test

A full range of measurements, performance data, CLF and Ease Data for AMS 6DC can be downloaded from [www.tannoypro.com](http://www.tannoypro.com).

Tannoy operates a policy of continuous research and development. The introduction of new materials or manufacturing methods will always equal or exceed the publishing specifications, which Tannoy reserves the right to alter without prior notice. Please verify the latest specifications when dealing with critical applications.

Copyright (c) 2015 Tannoy Limited. All rights reserved

Install

# AMS 6DC

6" Dual Concentric Surface-Mount  
Loudspeaker for Installation Applications



Install

# AMS 6DC

6" Dual Concentric Surface-Mount  
Loudspeaker for Installation Applications



Install

# AMS 6DC

6" Dual Concentric Surface-Mount  
Loudspeaker for Installation Applications



Install

# AMS 6DC

6" Dual Concentric Surface-Mount  
Loudspeaker for Installation Applications



Install

# AMS 6DC

6" Dual Concentric Surface-Mount  
Loudspeaker for Installation Applications

SUSPENDING THIS SYSTEM SHOULD ONLY BE DONE BY QUALIFIED PERSONS FOLLOWING SAFE INSTALLATION STANDARDS

MADE IN CHINA



## AMS 6DC

INPUT	POWER	WIRING	PASSIVE
70 V LINE	7.5, 15, 30, 60 W	1+ / 2-	INPUT
100 V LINE	15, 30, 60 W	3- / 4+	LINK
16 Ω	160 W PROGRAM	N/A	N/A

# TANNOY

DESIGNED AND ENGINEERED IN ENGLAND

DESIGNED AND ENGINEERED IN ENGLAND

# TANNOY



For service, support or more information contact the TANNOY location nearest you:

**Europe**  
**MUSIC Tribe Brands UK Ltd.**  
 Tel: +44156 273 2290  
 Email: CARECrea@music-group.com  
 CAREEnte@music-group.com  
 CARELife@music-group.com

**USA/Canada**  
**MUSIC Tribe Commercial NV Inc.**  
 Tel: +1 702.800 8290  
 Email: CARECrea@music-group.com  
 CAREEnte@music-group.com  
 CARELife@music-group.com

**Japan**  
**MUSIC Tribe Services JP K.K.**  
 Tel: +81 3 6231 0453  
 Email: CARECrea@music-group.com  
 CAREEnte@music-group.com  
 CARELife@music-group.com

MUSIC Tribe accepts no liability for any loss which may be suffered by any person who relies either wholly or in part upon any description, photograph, or statement contained herein. Technical specifications, appearances and other information are subject to change without notice. All trademarks are the property of their respective owners. MIDAS, KLARK TEKNIK, LAB GRUPPEN, LAKE, TANNOY, TURBOSOUND, TC ELECTRONIC, TC HELICON, BEHRINGER, BUGERA and COOLAUDIO are trademarks or registered trademarks of MUSIC Tribe Global Brands Ltd. © MUSIC Tribe Global Brands Ltd. 2018 All rights reserved.

