

SKM 5200

Instructions for use



Contents

Safety instructions	5
Delivery includes	6
The SKM 5200 radio microphone	6
The operating controls	8
Indications and displays	9
Preparing the radio microphone for use	10
Inserting, removing and changing the power pack	10
Changing the microphone head	12
Switching the radio microphone on/off	13
Doing a frequency check	14
The operating menu	15
The buttons	15
The automatic lock mode (autolock function)	16
Working with the operating menu	17
Overview of the operating menu	21
Adjustment tips for the operating menu	23
Selecting a channel – CHAN	23
Selecting the frequencies to be stored in the channel bank “VAR” – TUNE	23
Entering a name – NAME	25
Adjusting the microphone sensitivity – ATTEN	25
Adjusting the low-cut frequency – LOWCUT	26
Selecting the standard display – VIEW	26
Loading the factory-preset default settings – RESET	26
Activating/deactivating the automatic lock mode – LOCK ..	27
Exiting the operating menu – EXIT	27
If problems occur	28
Error checklist	28
Maintenance and care	29
Specifications	30
Accessories	31
Manufacturer declarations	32
Warranty regulations	32
Approval	32
Batteries or rechargeable batteries	32
WEEE Declaration	32

Safety instructions

- Please read these instructions carefully and completely before using the radio microphone.
- Make these instructions easily accessible to all users at all times. Always include these instructions when passing the radio microphone on to third parties.
- Never open electronic units! If units are opened by customers in breach of this instruction, the warranty becomes null and void.
- Water entering the housing of the radio microphone can cause a short-circuit and damage the electronics. Protect the radio microphone from damp and wet. Only use a slightly damp cloth to clean the radio microphone.

Safety instructions for handling rechargeable batteries

When used properly, rechargeable batteries are a safe and reliable energy source. However, if abused or misused, rechargeable batteries may leak and, in extreme cases, may even present an explosion and fire hazard. Please understand that Sennheiser does not accept liability for damage arising from abuse or misuse. Especially observe the following safety instructions:



- Observe correct polarity.
- Never short-circuit rechargeable batteries.
- Do not throw rechargeable batteries into fire.
- Do not expose rechargeable batteries to excessive heat.
- Do not mutilate or dismantle rechargeable batteries.
- To protect the environment, dispose of rechargeable batteries which cannot be recharged as special waste or return them to your specialist dealer.
- Store rechargeable batteries in a safe place and keep them away from children.
- Only charge rechargeable batteries with the appropriate charger.

Intended use of the radio microphone

Intended use includes

- having read these instructions especially the chapter “Safety instructions”.
- using the radio microphone within the operating conditions as described in these instructions.

Improper use of the radio microphone

Improper use is when you use the radio microphone other than described in these instructions or when you use the radio microphone under operating conditions different from those described in these instructions.

Delivery includes

- 1 radio microphone transmitter body
(microphone head and power pack to be ordered separately)
- 1 MZQ 3072 quick release clamp
- 9 color-coded identification markers
- 1 instructions for use

The SKM 5200 radio microphone

The SKM 5200 is a professional hand-held radio microphone transmitter that is easy to use and is easily adaptable to a wide variety of applications:

- Suitable for all-purpose use, e.g. for reporting, stage and studio applications.
- Rugged housing and intuitive, menu-assisted operation.
- Screw-on condenser microphone heads with different pick-up patterns (omni-directional, cardioid and super-cardioid) for a wide variety of applications. A super-cardioid dynamic microphone head capable of accommodating extremely high sound pressure levels is also available.
- Can be used with Neumann microphone heads for demanding live stage work (see “Changing the microphone head” on page 12).
- Microphone sensitivity can be adjusted in steps of 1 dB.
- Tunable transmission frequencies ensure high flexibility in varying transmission situations.

- Can be operated either on rechargeable or standard alkaline batteries – with LC display (in percent) of charging status on suitable receivers.
- HiDyn *plus*[™] noise reduction system ensures a wide dynamic range and low residual noise.
- Color-coded identification markers for quick and unambiguous identification.
- Frequency check mode for checking the transmission frequency without actually transmitting.

The channel bank system

The radio microphone has two channel banks. The channels of the channel bank “FIX” (fixed bank) have been factory pre-set to customer-specific transmission frequencies. These frequencies cannot be changed.

The channel bank “VAR” (variable bank) allows you to freely select and store frequencies.

Variants

- SKM 5200 (hematite-colored housing)
- SKM 5200 BK (black housing)
- SKM 5200 NI (nickel-colored housing)

Suitable receivers

- EM 1046 system (or EM 203)
- EM 3532, EM 3031, EM 3032
- EK 3041

The operating controls

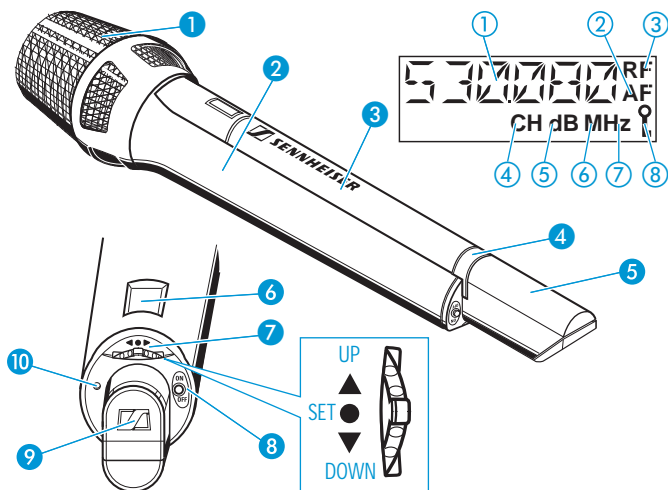

Operating controls

- ① Screw-on microphone head (not included in the delivery)
- ② Body of radio microphone
- ③ Power pack (not included in the delivery)
- ④ Battery compartment locking mechanism
- ⑤ Antenna
- ⑥ LC display
- ⑦ Multi-function switch with three switch positions:
▼ (DOWN), ▲ (UP) and SET
- ⑧ Red button (ON/OFF and ESC function)
- ⑨ Color-coded identification marker
- ⑩ LED for operation and battery status indication (ON/LOW BAT)

LC display panel

- ① Alphanumeric display
- ② Level display for audio signal "AF"
- ③ "RF" – appears when an RF signal is transmitted
- ④ "CH" – appears when the channel number is displayed
- ⑤ "dB" – appears when the microphone sensitivity is displayed
- ⑥ "MHz" – appears when the frequency is displayed
- ⑦ "Hz" – appears when the low-cut frequency is displayed
- ⑧ Lock mode icon

Indications and displays

Operation and battery status indication

The LED (ON/LOW BAT) ⑩ provides information on the current operating state of the radio microphone:

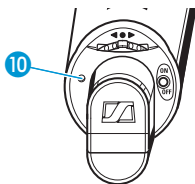

LED lit up: The radio microphone is switched on and the capacity of the power pack is sufficient.

LED flashing: The power pack is going flat (LOW BAT)!

Transmitter activity indication

A short time after switch-on, "RF" ③ appears on the display panel, indicating that the transmitter is active.



Display backlighting

When the lock mode is deactivated, the display remains backlit for approx. 20 seconds after pressing a button.

Preparing the radio microphone for use

Inserting, removing and changing the power pack

For powering the radio microphone, you can either use the Sennheiser B 5000 battery box (1.5 V AA size batteries) or the rechargeable Sennheiser BA 5000 battery pack. For regular use, we recommend using the environmentally friendly rechargeable BA 5000 battery pack.

Note:

For battery pack operation of the radio microphone, only use the BA 5000 battery pack in order to ensure optimum operational reliability. Batteries and rechargeable battery cells have different discharging curves. The radio microphone is able to identify the BA 5000 battery pack and to use its capacity to the full. Individual rechargeable battery cells in the B 5000 battery box will not be identified as battery packs.

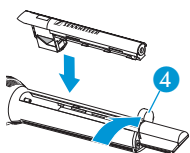

- ▶ To insert the power pack, open the locking mechanism 4 by moving it in the direction of the arrow.
- ▶ Insert the power pack into the radio microphone.

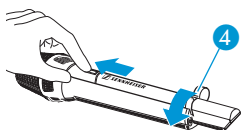

- ▶ Push the power pack towards the microphone head.
- ▶ Close the locking mechanism 4 by moving it in the direction of the arrow.

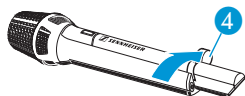

- ▶ To remove the power pack, open the locking mechanism 4 by moving it in the direction of the arrow.

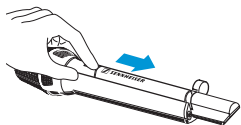

- ▶ Push the power pack towards the antenna. You can now remove the power pack.

Note:

After you have changed the power pack, the radio microphone continues operating on exactly the same settings as before the change. Stored settings are retained in memory on switch-off.

Inserting batteries into the B 5000 battery box

To ensure the longest operating time possible, only use alkaline manganese batteries for the B 5000 battery box.

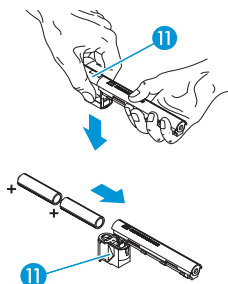

- ▶ To open the battery box, push down the display section of the battery box 11.
- ▶ Insert the batteries. Observe correct polarity when inserting the batteries.
- ▶ Close the battery box.

LC display shown on the example of the B 5000-1 battery box

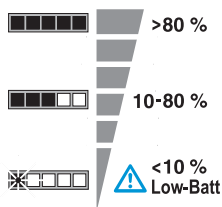

- 3-step LC display for remaining battery capacity.
- If the battery capacity is too low (LOW BAT), the last segment starts flashing and the batteries must be changed.

Recharging the BA 5000 battery pack

Before using the BA 5000 battery pack for the first time or if you have not used it for several weeks, you must charge the battery pack completely.

The L 50 charger can charge two BA 5000 battery packs simultaneously.

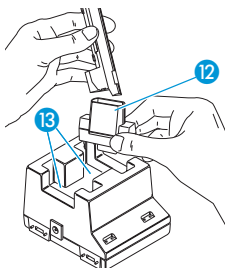

- ▶ Place the appropriate charging adapter 12 in the charging compartment 13 of the charger.
- ▶ Insert the BA 5000 battery pack into the charging adapter 12.

Charging time: approx. 2.5 hrs with the L 50 charger (dependent on the residual charge of the battery pack).

Note:

The battery pack is carefully charged using the – ΔU-method. For further details, please refer to the user manual of the L 50 charger.

LC display shown on the example of the BA 5000-1 battery pack

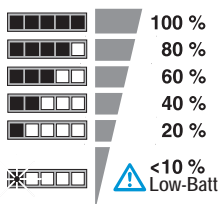

- 6-step LC display for (remaining) battery pack capacity.
- Microprocessor-controlled electronics takes self-discharge of rechargeable cells into account
- The maximum capacity of is reduced due to natural ageing of the cells. The BA 5000-1 battery pack measures the maximum capacity and therefore displays less than 100 % capacity for older cells – even when they have been fully charged.

Changing the microphone head

To change the microphone head of the SKM 5200:

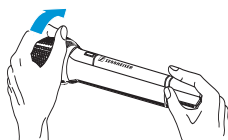

- ▶ Unscrew the microphone head by turning it in the direction of the arrow.

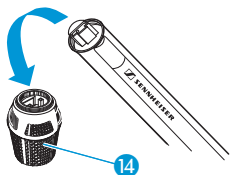

- ▶ Pull off the microphone head 14.
- ▶ Put on the new microphone head.
- ▶ Screw tight the microphone head by turning it against the direction indicated by the arrow.

Different microphone heads ensure suitability for a wide variety of applications:

Model	Type	Pick-up pattern	SPL
ME 5002	condenser	omni	138 dB
ME 5004	condenser	cardioid	139 dB
ME 5005	condenser, high feedback rejection	super-cardioid	154 dB

Model	Type	Pick-up pattern	SPL
ME 5005e	condenser, high feedback rejection	super-cardioid	158 dB
MD 5005	dynamic, high feedback rejection	super-cardioid	163 dB
ME 5009	condenser	wide cardioid	140 dB
KK 105 S (nickel-colored)	condenser (Neumann)	super-cardioid	155 dB
KK 105 BK (black)	condenser (Neumann)	super-cardioid	155 dB
KK 104 S (nickel-colored)	condenser (Neumann)	cardioid	153 dB
KK 104 BK (black)	condenser (Neumann)	cardioid	153 dB

Switching the radio microphone on/off

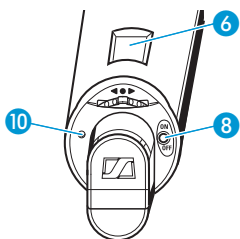

- ▶ To switch the radio microphone on, briefly press the red button **8**. The LED **10** lights up and the standard display is shown on the display panel; after a short pause, "RF" appears on the display panel. The LC display remains backlit for approx. 20 seconds.

Note:

- Remove the batteries or the battery pack when the radio microphone will not be used for extended periods of time.
- The radio microphone can only be switched off when the lock mode is deactivated (see page 16)



- ▶ To switch the radio microphone off, press the red button **8** until "OFF" appears on the display panel. The LED **10** and the display on the display panel **6** go off.

Note:

- When in the setting mode of the operating menu, the red button **8** will cancel your entry (ESC function).

Doing a frequency check

The radio microphone has a frequency check mode that prevents that the radio microphone transmits on an unwanted frequency after switch-on.

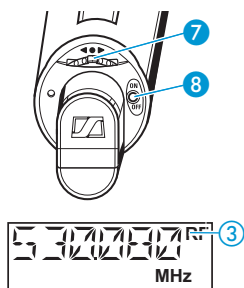

- ▶ When switching on the device, keep the red button 8 depressed. The current frequency is displayed on the display panel without the radio microphone transmitting.
- ▶ If the displayed frequency is the wanted frequency, you can release the red button 8. After five seconds the “RF” 3 icon appears and the radio microphone starts transmitting.

If you want to select another frequency, proceed as follows:

- ▶ Release the red button 8.
- ▶ Within five seconds, press the multi-functions switch 7 twice (switch position •SET).

You will be passed to the “CHAN” or “TUNE” menu and can change the transmission frequency as required. (See “Adjustment tips for the operating menu” on page 23.)

Identifying the radio microphone

The radio microphone comes with nine interchangeable color-coded identification markers, allowing you to clearly identify each radio microphone.

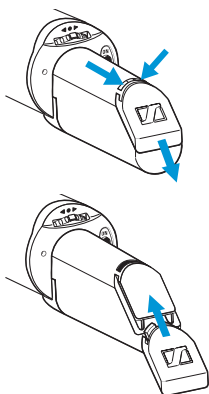

- ▶ To remove the identification marker, press the two snap-in pins together while sliding the identification marker out of the guide rails.
- ▶ Put on the new identification marker by sliding it onto the guide rails.

The operating menu

The buttons

Button	Mode	Function
Red button (ON/OFF, ESC)	Switched off	<ul style="list-style-type: none">• Briefly pressing the button: Switching the radio microphone on• Keeping the button pressed: Doing a frequency check
	Display mode	<ul style="list-style-type: none">• Briefly pressing the button (with activated autolock function): Immediately activating the lock mode• Briefly pressing the button (with activated lock mode): Calling up the lock mode for deactivation• Pressing the button for 3 sec. (with deactivated lock mode): Switching the radio microphone off
	Selection mode	Canceling the entry and returning to the display mode
	Setting mode	Canceling the entry and returning with the last setting stored to the last parameter displayed in the display mode
•SET	Display mode	<ul style="list-style-type: none">• With deactivated lock mode: Changing to the selection mode• With activated lock mode: Calling up the lock mode for deactivation
	Selection mode	Changing to the setting mode of the selected menu
	Setting mode	Storing the setting and returning to the selection mode ("STORED" is displayed)
▲ (UP)/ ▼ (DOWN)	Display mode	Changing to the previous parameter (▲) or changing to the next parameter (▼)
	Selection mode	Changing to the previous menu (▲) or changing to the next menu (▼)
	Setting mode	Increasing (▲) or reducing (▼) the setting of the selected menu

The automatic lock mode (autolock function)

The radio microphone has a lock mode that prevents that the radio microphone is accidentally programmed while operating. When the autolock function is activated via the "LOCK" menu (see "Activating/deactivating the automatic lock mode – LOCK" on page 27) the lock mode is automatically activated 10 seconds after pressing the last button and remains activated. .



Prior to this, the lock mode icon ⑧ flashes several times on the display. At the same time, the display back-lighting goes off.

Note:

You can deactivate the autolock function either permanently (see page 27) or temporarily (see page 16).

Deactivating the autolock function temporarily

To be able to make changes to the settings via the operating menu, you must temporarily deactivate the lock mode.

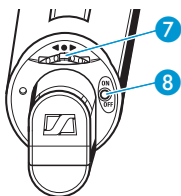

- ▶ To achieve this, either press the red button ⑧ or the multi-function switch ⑦ (switch position •SET).

"LOCK" appears on the display panel.

- ▶ Slide the multi-function switch ⑦ to the position ▲ (UP) or ▼).

"UNLOCK" appears on the display panel.

- ▶ Press the multi-function switch ⑦ (switch position •SET).

You can now change the settings.

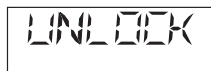
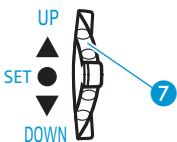

After you have exited the operating menu, the lock mode is automatically re-activated after 10 seconds. You can also immediately activate the lock mode by pressing the red button ⑧ briefly.

Working with the operating menu

The operating menu has three modes:

- Display mode
In display mode, you can display the current menu settings one after the other – even when the lock mode is activated.
- Selection mode
In selection mode, you can select the menu whose setting you want to change. To change to the selection mode, the lock mode must be deactivated.
- Setting mode
In setting mode, you can change the setting of the selected menu.

By way of example of the “LOWCUT” menu, this section describes how to use the operating menu.

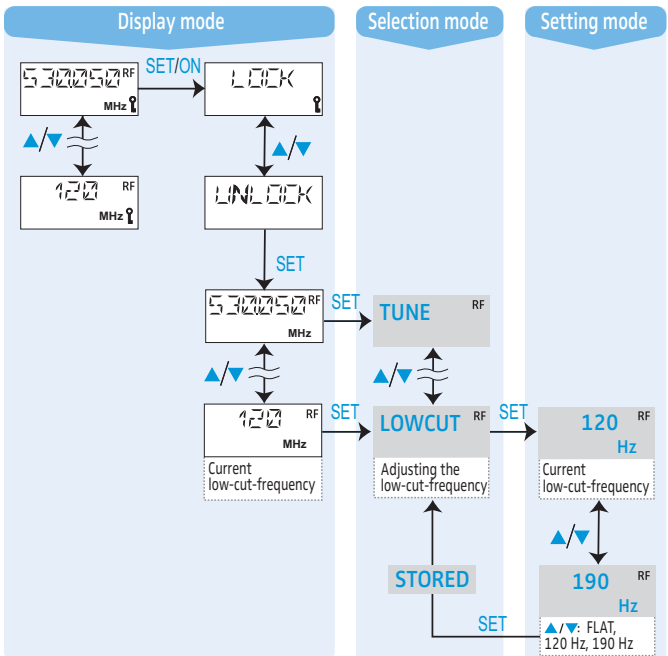

After switch-on

After switch-on, the standard display is shown on the display panel. Depending on the setting, the transmission frequency, the channel number or the name of the radio microphone is displayed.

Displaying the menu settings in display mode

In display mode, and with the lock mode activated, you can display the current menu settings one after the other (see “Overview of the operating menu” on page 21). After a few seconds, the display returns to the standard display. With the lock mode activated, the LC display is not backlit.

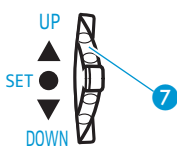

- ▶ Slide the multi-function switch 7 to the position ▲ (UP) or ▼ (DOWN) to display the menu settings. If you slide the multi-function switch repeatedly to the same position, all menu settings are displayed one after the other.

Changing to the selection mode

To change from display mode to selection mode, you have to deactivate the lock mode.

- ▶ Deactivate the lock mode (see “Deactivating the autolock function temporarily” on page 16). You can now select the menu whose settings you want to adjust.
- ▶ Press the multi-function switch 7 (switch position •SET) to change to the menu that was displayed in display mode.

Selecting a menu

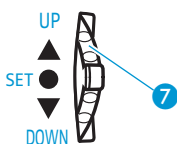

- ▶ Slide the multi-function switch 7 to the position ▲ (UP) or ▼ (DOWN).
- ▶ Press the multi-function switch 7 (switch position •SET). The name of the selected menu starts flashing.

The following menus are available:

Menu	Function of the menu
CHAN	Selecting a channel
TUNE	Setting transmission frequencies for the channel bank "VAR" (variable bank)
NAME	Entering a name
ATTEN	Adjusting the microphone sensitivity
LOWCUT	Adjusting the low-cut frequency
VIEW	Selecting the standard display
RESET	Loading the factory-preset default settings
LOCK	Activating/deactivating the autolock function
EXIT	Exiting the operating menu and returning to the standard display

Changing to the setting mode of a selected menu

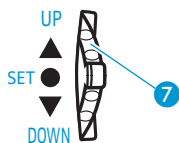

- ▶ Press the multi-function switch 7 (switch position •SET) to change to the setting mode of the selected menu.

The current setting that can be adjusted flashes on the display.

Adjusting a setting

- ▶ Use the multi-function switch 7 to adjust the setting of the selected menu.

By briefly sliding the multi-function switch 7 to the position ▲ (UP) or ▼ (DOWN), the display jumps either forwards or backwards to the next setting.

In the "ATTEN", "CHAN", "TUNE" and "NAME" menu and when slid to the position ▲ (UP) or ▼ (DOWN), the multi-function switch features a "fast search" function, i.e. the display cycles continuously. In the "TUNE" menu, the cycling of the display is continuously accelerated. The "fast search" function allows you to get fast and easily to your desired setting.

Storing a setting

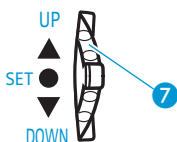

- ▶ Press the multi-function switch **7** (switch position **•SET**) to permanently store a setting. "STORED" appears on the display panel, indicating that the setting has been stored.

The display then returns to the top menu level.

With most menus, new settings become effective immediately without having to be stored. An exception are the "TUNE" and "CHAN" menus. With these menus, new settings only become effective after they have been stored ("STORED" appears on the display panel, indicating that the setting has been stored).

Exiting the operating menu

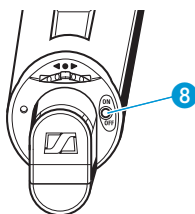

- ▶ Select the "EXIT" menu to exit the operating menu and to return to the standard display.

When in the operating menu, pressing the red button **8** will cancel your entry (ESC function) and return you to the standard display with the last stored settings.

Overview of the operating menu

Deactivate the lock mode before adjusting the settings (see “Deactivating the autolock function temporarily” on page 16). Pressing the red button **8** will cancel your entry (ESC function) and return you to the display mode.

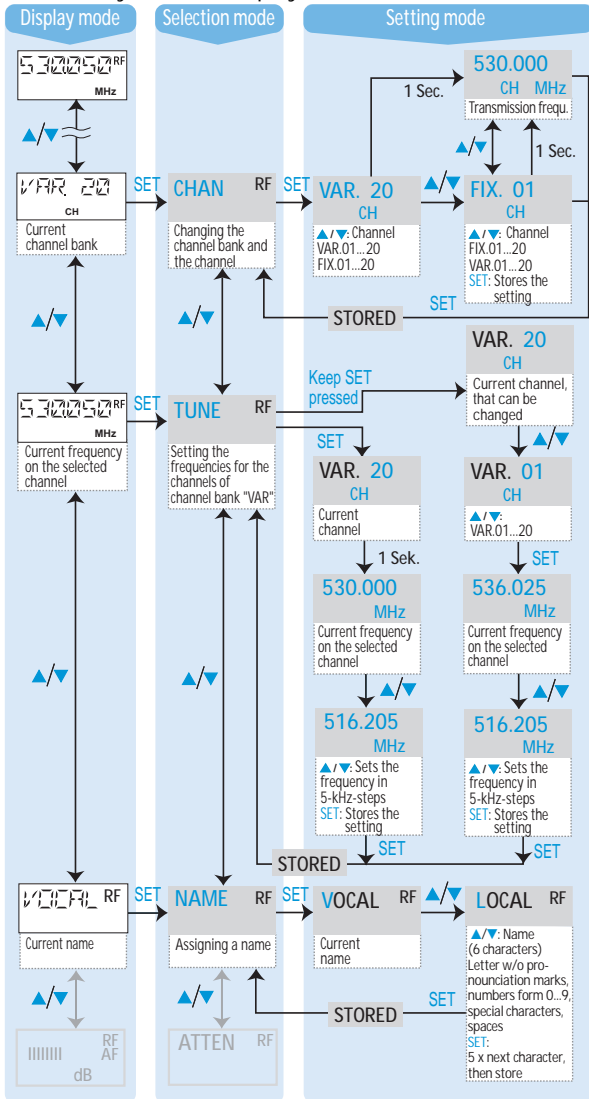

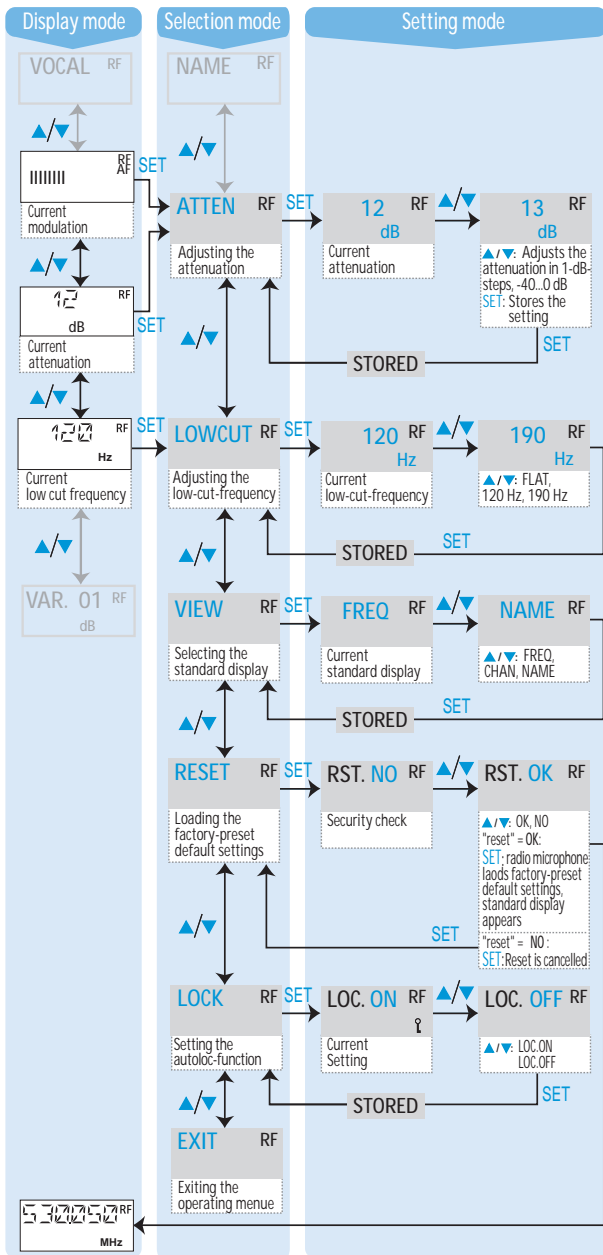

Adjustment tips for the operating menu

Selecting a channel – CHAN

Via the “CHAN” menu, you can switch between the channels in the channel banks “FIX” and “VAR”. The radio microphone is not transmitting while this adjustment is being made.

When changing to the setting mode of the “CHAN” menu, the current channel number appears on the display. After approx. 1 second, the currently assigned frequency is displayed.

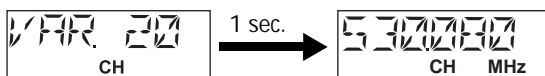

- ▶ To select a different channel, slide the multi-function switch to the position ▲ (UP) or ▼ (DOWN). The new channel number appears on the display panel for approx. 1 second and then the currently assigned frequency is displayed.

Only after the new setting has been stored (“STORED” has appeared on the display panel) does the transmitter operate on the transmission frequency of the new channel.

Selecting the frequencies to be stored in the channel bank “VAR” – TUNE

Via the “TUNE” menu, you can freely select the frequencies to be stored in the channel bank “VAR” (variable bank). The radio microphone is not transmitting while this adjustment is being made.

Note:

When you have selected the channel bank “FIX” and then select the “TUNE” menu, the radio microphone automatically switches to channel 01 of the channel bank “VAR” and “VAR” briefly appears on the display panel.

The transmission frequencies are tunable in 5-kHz steps within a switching bandwidth of 36 MHz max.

Note:

When operating a multi-channel system, make sure to only use intermodulation-free frequencies.

There are two options for setting the frequencies:

- You can set a new frequency for the selected channel:

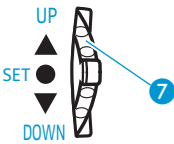

- ▶ In the selection mode of the "TUNE" menu, press the multi-function switch 7 (switch position •SET). The current channel number appears on the display and then the currently assigned frequency is displayed.

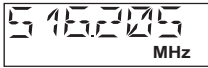

- ▶ Change the frequency by sliding the multi-function switch 7 to the position ▲ (UP) or ▼ (DOWN).
- ▶ Store your setting.

- You can change to a different channel and set a new frequency for the new channel:

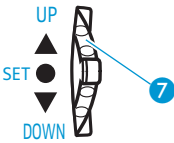

- ▶ Press the multi-function switch for a longer time 7 (switch position •SET). The current channel flashes on the display.
- ▶ Select a new channel by sliding the multi-function switch 7 to the position ▲ (UP) or ▼ (DOWN).
- ▶ Confirm your selection by pressing the multi-function switch (switch position •SET).

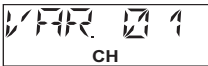
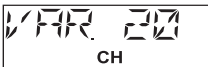

- ▶ The current frequency of the selected channel is displayed. Change the frequency by sliding the multi-function switch 7 to the position ▲ (UP) or ▼ (DOWN).
- ▶ Store your setting.

Entering a name – NAME

Via the “NAME” menu, you can enter a freely selectable name for the radio microphone. This name can be displayed on the standard display and can consist of up to six characters such as:

- letters (without pronunciation marks),
- numbers from 0 to 9,
- special characters and spaces.

After you have changed to the setting mode of the “NAME” menu, the first segment starts flashing on the display.

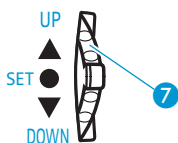

- ▶ Slide the multi-function switch ⑦ to the position ▲ (UP) or ▼ (DOWN) to select a character. (By sliding the switch only once, the display jumps either forwards or backwards to the next character. If you keep the switch slid, the display starts cycling continuously.)
- ▶ Press the multi-function switch ⑦ (switch position ●SET) to change to the next segment.
- ▶ Have you entered the name completely? Press the multi-function switch ⑦ (switch position ●SET) to store your setting. “STORED” appears on the display panel.

Adjusting the microphone sensitivity – ATTEN

Via the “ATTEN” menu, you can adjust the radio microphone’s sensitivity by changing its input attenuation.

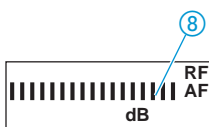

The input attenuation is correctly adjusted when the level display for audio signal “AF” ⑧ shows full deflection only during the loudest passages. The input attenuation can be adjusted in 1-dB steps from –40 dB to 0 dB.

Microphone sensitivity of the SKM 5200 and the SKM 5000:

SKM 5200: Setting in dB	-40	-30	-20	-10	0
SKM 5000: Switch position	1	2	3	4	5

Adjusting the low-cut frequency – [LOWCUT](#)

To reduce unwanted low-frequency noise such as engine, wind and rumble noise, you can activate a low-cut filter. The low-cut frequency can be set to 190 Hz or 120 Hz.

If you do not want to reduce low-frequency signal portions, select the setting “FLAT”.

Selecting the standard display – [VIEW](#)

Via the “[VIEW](#)” menu, you can select one of the following standard displays:

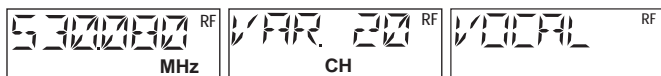

Transmission
frequency “[FREQ](#)”

Channel
“[CHAN](#)”

Name
“[NAME](#)”

The selected standard display is shown

- after switch-on,
- after the menu settings have been displayed in display mode.

Loading the factory-preset default settings – [RESET](#)

Via the “[RESET](#)” menu, you can load the factory-preset default settings. After the reset, the standard display is shown on the display panel.

Low-cut frequency	flat
Microphone sensitivity	-20 dB
Name	5200
Standard display	frequency
Autolock function	deactivated
Channel	FIX 01
Frequencies in the channel bank	“ VAR ” are reset

Activating/deactivating the automatic lock mode – LOCK

The radio microphone has an autolock function (automatic lock mode) that can be activated or deactivated via the “LOCK” menu. When the autolock function is activated, the lock mode is automatically activated 10 seconds after pressing the last button. The lock mode protects the radio microphone from accidental programming. For daily use, we would recommend activating the autolock function.

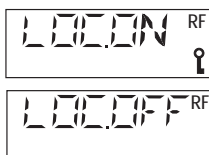
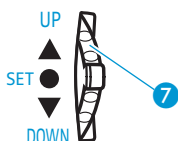

- ▶ In the selection mode of the “LOCK” menu, press the multi-function switch 7 (switch position •SET). The current setting of the autolock function is displayed.
- ▶ Change the setting by sliding the multi-function switch 7 to the position ▲ (UP) or ▼ (DOWN). Select “LOC.ON” to activate the autolock function or select “LOC.OFF” to deactivate the autolock function.
- ▶ Store your setting.

Exiting the operating menu – EXIT

Via the “EXIT” menu, you can exit the operating menu and return to the standard display.

When in the operating menu, briefly pressing the red button will cancel your entry (ESC function) and return you to the standard display without saving any changes.

If problems occur ...

Error checklist

Problem	Possible cause	Possible solution
No operation indication	Batteries are flat or inserted incorrectly, battery pack is flat	Replace the batteries or check if they are inserted correctly or recharge the battery pack
Transmitter cannot be switched off/ Settings cannot be changed	Lock mode is activated	Deactivate the lock mode (see "Deactivating the autolock function temporarily" on page 16)
Receiver: No RF signal	Transmitter and receiver are not on the same channel	Set transmitter and receiver to the same channel
	Transmitter is out of range	Check the squelch threshold setting or reduce the distance between receiving antenna and transmitter
Weak signal	Antenna signal is attenuated	Do not clasp the antenna section
Audio signal has a high level of background noise	Transmitter's input attenuation is adjusted too high	See "Adjusting the microphone sensitivity – ATTEN" on page 25
	Receiver's output level is adjusted too low	Increase the line output level
Audio signal is distorted	Transmitter's input attenuation is adjusted too low	See "Adjusting the microphone sensitivity – ATTEN" on page 25
	Receiver's output level is adjusted too high	Reduce the line output level

If problems occur that are not listed in the above table or if the problems cannot be solved with the proposed solutions, please contact your local Sennheiser agent for assistance.

Tips for optimum reception

- The transmission range depends to a large extent on the location and can be up to 150 m. There should be a “free line of sight” between transmitting and receiving antennas.
- To avoid overmodulating the receiver, observe a minimum distance of 5 m between transmitting and receiving antennas.
- Do not clasp the antenna section of the radio microphone with both hands.

Tips for multi-channel operation

- When operating a multi-channel system, make sure to only use intermodulation-free frequencies.

Maintenance and care

CAUTION!



Water can damage the electronics of the radio microphone!

Water entering the housing of the radio microphone can cause a short-circuit and damage the electronics.

- ▶ Only use a slightly damp cloth to clean the radio microphone.

If the radio microphone is soiled, you can clean it with a slightly damp cloth.

Note:

Do not use any cleansing agents or solvents.

Specifications

Modulation	wideband FM
Frequency range	450–960 MHz
Switching bandwidth	36 MHz
Transmission frequencies	channel bank “FIX” with customer-specific frequencies channel bank “VAR” with 20 freely selectable frequencies (frequencies tunable in steps of 5 kHz)
RF output power	50 mW (–3 dB) at 50 Ω
Frequency stability	± 10 kHz within the specified temperature range
Spurious emission	< 4 nW
Nominal/peak deviation	± 40 kHz/ ± 56 kHz FM
Signal-to-noise ratio	typ. 114 dB (A) _{rms} (ATTEN –40 dB)
THD (at 1 kHz, nom. deviation)	< 0.5 %
AF frequency response	60–20,000 Hz
Noise reductions system	Sennheiser HiDyn <i>plus</i> [™]
Low-cut frequency (–3 dB)	adjustable (flat, 120 Hz, 190 Hz)
Sensitivity	adjustable in steps of 1 dB from –40 to 0 dB
Power supply	via B 5000 (two AA size cells) or BA 5000 (battery pack)
Operating time	typ. 8 h with B 5000-1 typ. 8 h with BA 5000-1
Temperature range	–10 to +55 °C
Dimensions	length: 200 mm, \varnothing 35.5 mm
Weight	approx. 300 g
Type approval	USA: FCC-Part 74.861 FCC ID: DMOSKM52 Canada: RSS-123 IC: 2099A-SKM5200 EU: ETSI EN 300 442-1/-2 CE 0682!

Accessories

- 003763 ME 5009 microphone head
- 003760 ME 5005 microphone head
- 005249 ME 5005e microphone head
- 003762 ME 5004 microphone head
- 003761 ME 5002 microphone head
- 003823 MD 5005 microphone head
- 008474 Neumann KK 105 S microphone head
- 008476 Neumann KK 105 S-BK microphone head
- 008533 Neumann KK 104 S-BK microphone head
- 008534 Neumann KK 104 S microphone head
- 005273 B 5000-1 battery box
- 005274 BA 5000-1 battery pack incl. charging adapter for the L 50 charger
- 003554 L 50 charger (for BA 5000 battery pack)
- 051662 Charging adapter for L 50 charger
- 003824 MZW 5000-ANT windshield, anthracite, without identification ring
- 003825 MZW 5000-BL windshield with blue identification ring
- 003826 MZW 5000-GE windshield with yellow identification ring
- 003827 MZW 5000-GN windshield with green identification ring
- 003828 MZW 5000-RT windshield with red identification ring
- 003829 MZW 5000-WS windshield with white identification ring
- 512888 9 color-coded identification markers

Manufacturer declarations

Warranty regulations

The guarantee period for this Sennheiser product is 24 months from the date of purchase. Excluded are accessory items, rechargeable or disposable batteries that are delivered with the product; due to their characteristics these products have a shorter service life that is principally dependent on the individual frequency of use.

The guarantee period starts from the date of original purchase. For this reason, we recommend that the sales receipt be retained as proof of purchase. Without this proof (which is checked by the responsible Sennheiser service partner) you will not be reimbursed for any repairs that are carried out.

Depending on our choice, guarantee service comprises, free of charge, the removal of material and manufacturing defects through repair or replacement of either individual parts or the entire device. Inappropriate usage (e.g. operating faults, mechanical damages, incorrect operating voltage), wear and tear, force majeure and defects which were known at the time of purchase are excluded from guarantee claims. The guarantee is void if the product is manipulated by non-authorised persons or repair stations.

In the case of a claim under the terms of this guarantee, send the device, including accessories and sales receipt, to the responsible service partner. To minimise the risk of transport damage, we recommend that the original packaging is used. Your legal rights against the seller, resulting from the contract of sale, are not affected by this guarantee.

The guarantee can be claimed in all countries outside the U.S. provided that no national law limits our terms of guarantee.

Approval

 This equipment is in compliance with the essential requirements and other relevant provisions of Directives 1999/5/EC, 89/336/EC or 73/23/EC. The declaration is available on the internet site at www.sennheiser.com.

Before putting the device into operation, please observe the respective country-specific regulations!

Batteries or rechargeable batteries



Please dispose of batteries or rechargeable batteries as special waste or return them to your specialist dealer.

WEEE Declaration



Please dispose of this product at the end of its operational lifetime by bringing it to your local collection point or recycling centre for such equipment.



Sennheiser electronic GmbH & Co. KG
30900 Wedemark, Germany
Phone +49 (5130) 600 0
Fax +49 (5130) 600 300
www.sennheiser.com