

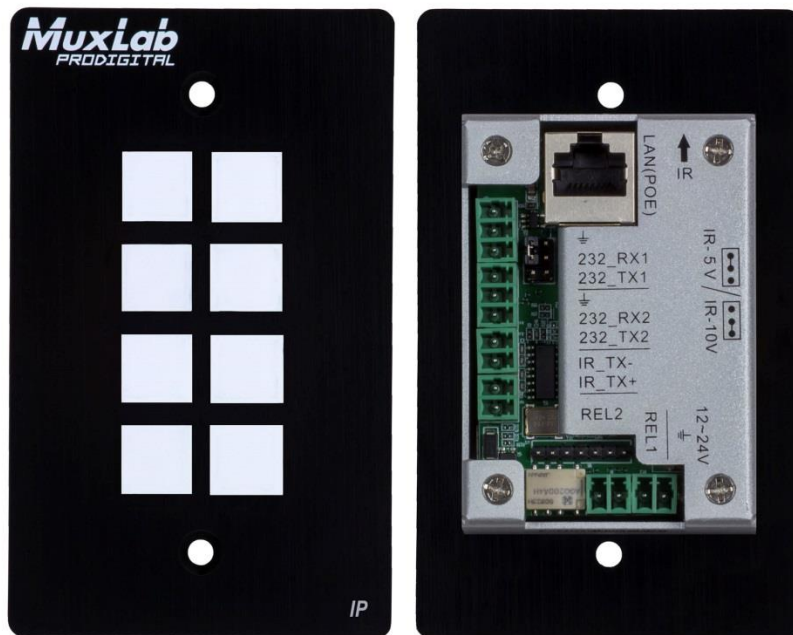

8 Button IP PoE Control Panel Installation and Operation Manual 500816-IP-V2



Introduction

The 8 Button IP PoE Control Panel (Model: 500816-IP-V2) is a versatile wall or table-top mounted control panel for MuxLab AV over IP devices, select Matrix Switches, and third party products. Each button is programmable. The unit supports one (1) Ethernet port (for TCP/IP, Telnet, HTTP and UDP), two (2) RS-232 ports, one (1) Infrared port, and two (2) Relay ports, for control of end devices. The 8 Button IP PoE Control Panel can control MuxLab products including MuxLab's AV over IP system via the 500812 ProDigital Network Controller, MuxLab's TCP/IP, Telnet and RS-232 managed Matrix Switches, as well as third party devices such as projectors and projector screens, displays, AV sources and other similar devices.

The 500816-IP-V2 supports a web interface, allowing it to be configured and managed via a browser. The web interface allows the unit keys to be programmed individually, supports IR learning and unit configuration.

Panel Description

Front panel view:

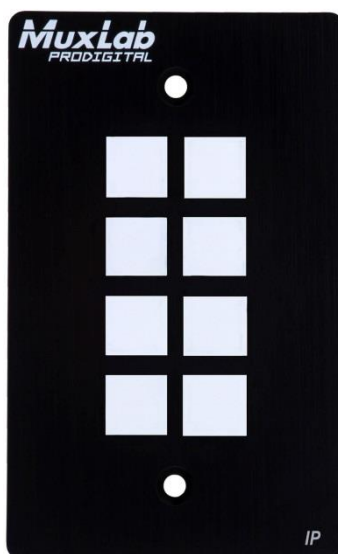

All buttons can be programmed to control each TCP/IP, Telnet, HTTP, UDP, RS-232, IR, and Relay controllable end device. Each key supports a removable clear plastic cover, allowing a label to be inserted to reflect the programming of each button.

Rear panel view:

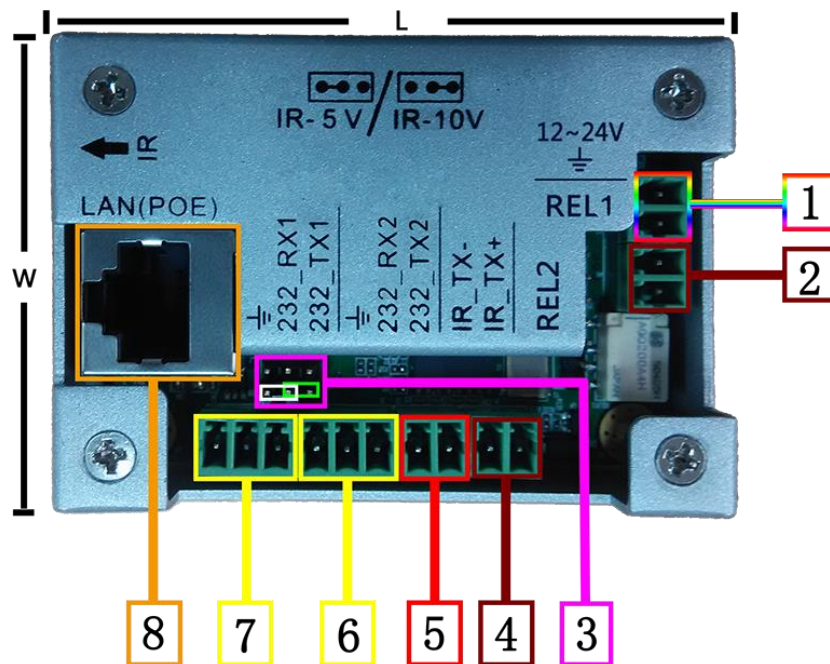

1. Power: DC Power Input supporting 12-24VDC (12VDC@1A is recommended)
2. Relay #1: An electrically operated switch
3. IR output power jumper: jumper left 2 pins for 5V, or right 2 pins for 10V.
4. Relay #2: An electrically operated switch
5. IR: Infrared radiation digital data output
6. Rs232 #2: RS-232 data output
7. Rs232 #1: RS-232 data output
8. LAN (PoE): LAN port with PoE (PD) power for web interface control

Top panel view:

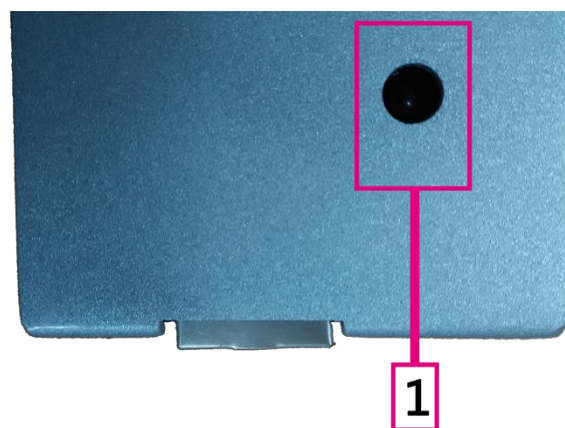

1. IR reader: Learning IR sensor, supporting a frequency of 38KHz

Configuration: Unit Initialization

Before initial use, the user must initialize (factory reset) the configuration of 500816-IP-V2. To initialize the unit, hold down the fourth and eighth keys as shown below. Continue to hold these two keys while they light up grey, green and red, after these keys light up red, release them and you will see all 8 keys turn off, then they all light up green, then each of the 8 buttons, doing a sequence, they will light up red, then they will do another sequence so they all light up green, and then they all flash green to end the sequence. Please note that this restores the factory default settings.

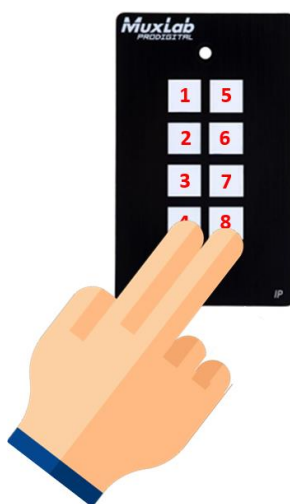

Web Server

The units comes with a factory default IP Address of: 192.168.168.54

To access the unit web server, the user can directly connect a PC LAN port to the 500816-IP-V2 LAN port with a straight polarity Ethernet cable. After connecting the PC and 8 Button IP PoE Control Panel, go to the PC network connection section to change the PC's IP property status to "Static IP" and set the PC IP address to say 192.168.168.178, Subnet Mask to 255.255.255.0 and Default Gateway to 192.168.168.1, as shown below. Once done, open a web browser and enter the IP Address 192.168.168.54 to access to the 500816-IP-V2 web server.

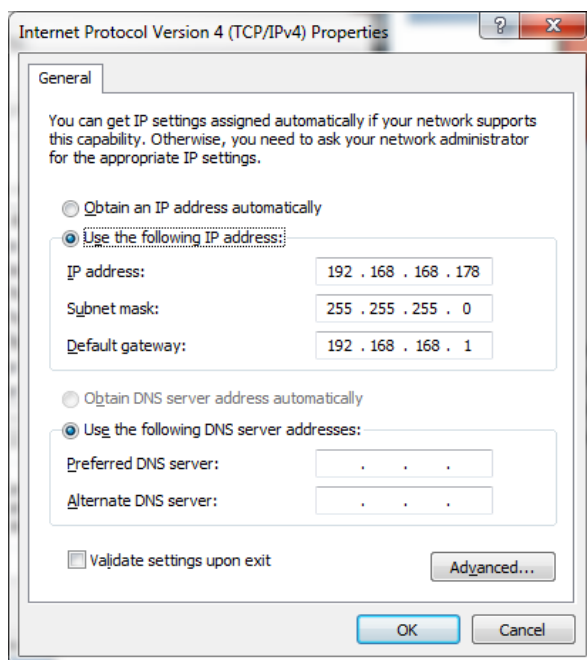

The user must now set the 8 Button IP PoE Control Panel to the same IP segment as the local area network where the device will be used. To accomplish select the SYSTEM tap and go to the Network section via the 500816-IP-V2 web interface, see below, and set the 8 Button IP PoE Control Panel IP address accordingly to match the local area network IP Address setting.

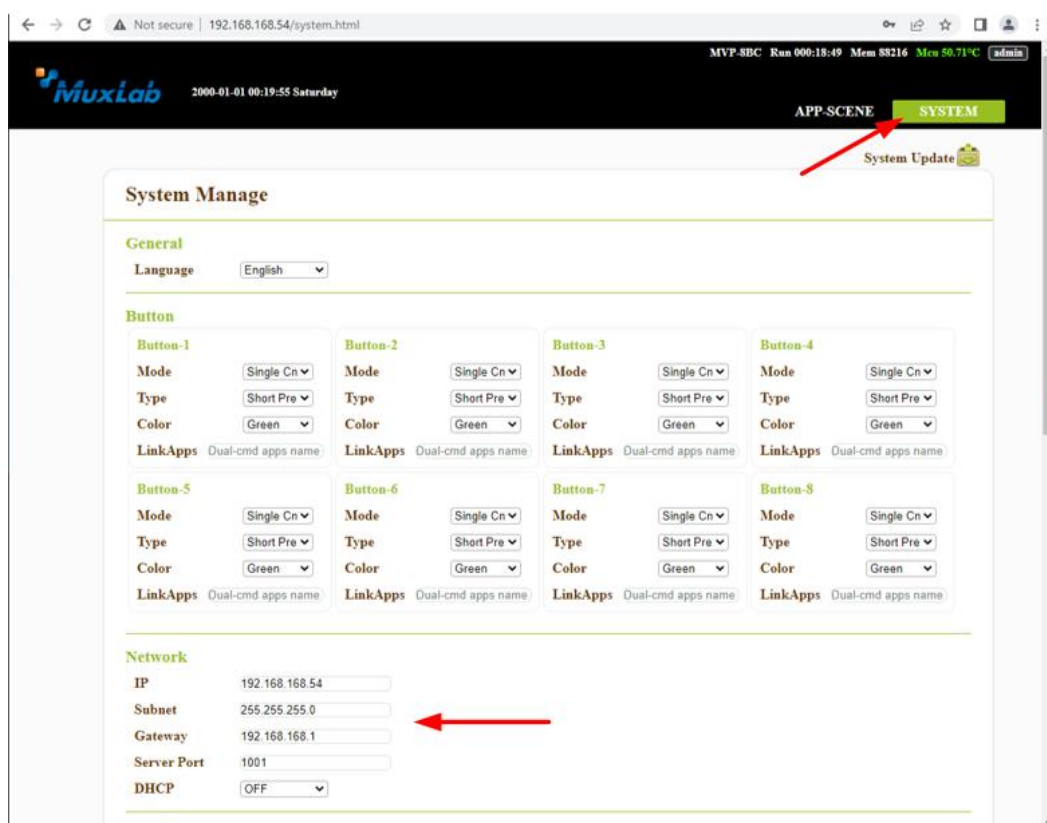

For example, if the LAN IP segment is set as 192.168.88.xxx, then set the product IP Address to 192.168.88.1xx. Once the IP Address is set, then the user can access this device in the intended local area network via the 500816-IP-V2 web interface using the IP Address 192.168.88.1xx (where xx represents the settings selected above).

After accessing the 8 Button IP PoE Control Panel web server, the default user ID is **admin**, and the password is **admin**. Login to configure and manage the unit.

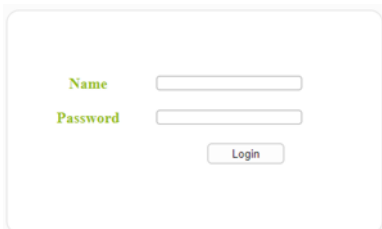

The image shows a login form with two input fields and a button. The first field is labeled 'Name' and the second is labeled 'Password'. Below the fields is a button labeled 'Login'.

System Page

After login, click SYSTEM tab to manage system options.

System management mainly includes System Update, General Settings, Button Settings, Network Configuration, Serial Port Configuration, Infrared Settings, Relay Settings, Administrator User Modification and User Data (see below). Users can configure them according to actual requirements. System update is described in the Update Firmware section.

MVP-SBC Run 000:16:17 Mem 88208 Mcu 50.71°C admin

2000-01-01 23:04:14 Saturday

APP-SCENE SYSTEM

System Update 

System Manage

General

Language English

Button

Button-1

Mode Single Cn

Type Short Pre

Color Green

LinkApps Dual-cmd apps name

Button-2

Mode Single Cn

Type Short Pre

Color Green

LinkApps Dual-cmd apps name

Button-3

Mode Single Cn

Type Short Pre

Color Green

LinkApps Dual-cmd apps name

Button-4

Mode Single Cn

Type Short Pre

Color Green

LinkApps Dual-cmd apps name

Button-5

Mode Single Cn

Type Short Pre

Color Green

LinkApps Dual-cmd apps name

Button-6

Mode Single Cn

Type Short Pre

Color Green

LinkApps Dual-cmd apps name

Button-7

Mode Single Cn

Type Short Pre

Color Green

LinkApps Dual-cmd apps name

Button-8

Mode Single Cn

Type Short Pre

Color Green

LinkApps Dual-cmd apps name

Network

IP 192.168.168.54

Subnet 255.255.255.0

Gateway 192.168.168.1

Server Port 1001

DHCP OFF

Serial Port

RS232-1

Baud Rate 115200

Data Bits 8 bits

Stop Bits 1 bits

Parity Bits None

RS232-2

Baud Rate 115200

Data Bits 8 bits

Stop Bits 1 bits

Parity Bits None

IR Set

IR Carrier 38KHz

Relay Sw

RELAY-1 OFF

RELAY-2 OFF

Administrator Modify

Name

Password

NewName

NewPassword

Modify

User Data

Data Backup Choose File No file chosen Restore Backup Reboot Reset Sync Time

About Host

Host MVP-SBC

Hardware v3.0.0.220909

Software v1.0.8.230303

BuildTime Mar 3 2023

System Update:

This option will be seen in detail in the “Firmware Update” section.

General:

Language: Users can select between English, Russian or Chinese the language of the web interface.

Button Settings:

Users can set the buttons options.

The screenshot displays a web interface for configuring eight buttons. On the left, a legend identifies the configuration options: 1 → Mode, 2 → Type, 3 → Color, and 4 → LinkApps. Each button (Button-1 through Button-8) has a corresponding configuration panel with dropdown menus for Mode (Single Cn), Type (Short Pre), and Color (Green), and a text input field for LinkApps (Dual-cmd apps name).

1. Mode: Select Single Command mode or Dual Command mode.
 - a- Single command mode: press the button each time you need to execute the scene programmed in that button.
 - b- Dual command mode: press the button for the first time to execute the scene programmed in that button and press the button for the second time to execute the scene entered in LinkApps.
2. Type: The user can set the button to Short Press if he needs to send the programmed scene once every time the button is touched, or he can set the button to Sustained if he needs to send the programmed scene continuously while the button is pressed.
3. Colour: Users can change the color of the buttons between red and green or turn them off.
4. LinkApps: Type here the name of the scenario that the button binds to if Dual Command mode is selected.

Network:

The User can set IP Address, Subnet Mask, Default Gateway, Server Port and DHCP info in the Network Control sub-section.

Serial Port:

The User can set RS232_1 and RS232_2 Baud Rate, Data Bits, Stop bit and Parity settings.

Infrared Settings:

The User can select the frequency of sending the infrared commands.

Infrared Settings:

The User can configure the states of the relays.

Administrator Modify:

The user can modify his user credentials (Name and Password).

User Data:

The User can synchronize the time, do a reboot, do a reset, do a system backup or restore a system backup.

App-Scene Page

The App-Scene page is displayed after a successful login. By default, eight scenarios are shown, one for each button (BTN1, BTN2,, BTN8) and an initial scenario (Init) that is programmed to display a sequence of colors on the buttons every time we turn on the unit. Each scenario can contain multiple commands. When running a scenario, the system automatically runs each command based on the sequence and the configured time between them. Scenario commands need to be configured based on the actual environment. The user can click a scene to execute the real button functions from the web interface page. This can be used to test the programming of the button.

Creating a Scene

To create a new scene, click the "New Apps" icon, a pop-up window will appear asking you to enter a name for the new scene, click "Save" to confirm the name or click "Cancel" to cancel the process.



Enter Scene Editing

After saving a newly created scene, the system will automatically open a window where the user can edit the scene. If you want to edit an existing scene, follow the steps below:

1. Select the editor mode by clicking the "Editor" option.
2. Click the settings icon for the scene you want to edit.



Scene Editing Page

On this page, the user can set scene commands, set trigger conditions, set timers, define execution sequences, and more.

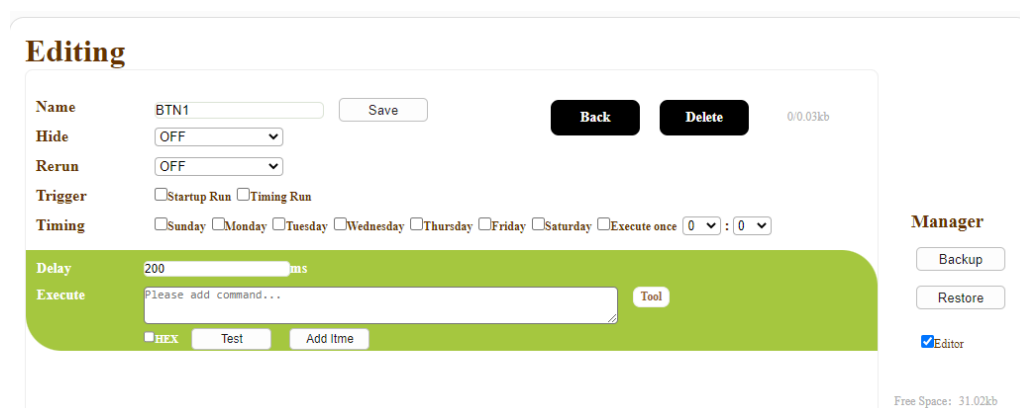

Scene Settings

1. Set the name and click "Save" to Save the name.
2. Click "Back" to return to the scene page.
3. Click "Delete" to delete the scene.
4. Memory space used by the scene.
5. By selecting ON, the scene will not be displayed on the interface, but it can be executed by invoking a command.
6. By selecting ON, when the scene is executed, it will repeat continuously.
7. Set the trigger mode for the scene, either every time the device is turned on or a specific day and time.

(Note: Since the device does not have a battery and can only be used with a constant power supply, it is necessary to synchronize the date and time every time the power supply is interrupted by clicking the "Sync Time" button on the System page).

Editing Commands in a Scene

1. Set the delay time, in milliseconds, before executing a command.
2. In this box the user can view, enter, or modify the programmed command.
3. Click "Tool" to enter the command generation page.
4. If "HEX" is selected, the command is displayed in hexadecimal format.
5. Click "Test" to test the command.
6. Click "Save" to save delay and command Settings.
7. Click "Delete" to delete the current command.
8. Click "Move Up" to move the command up in the execution sequence.
9. Click "Move Down" to move the command down in the execution sequence.
10. Click "Add Item" to add the command to the execution sequence.

Command Generation Tool

Click the "Tool" button to enter the command generation page.

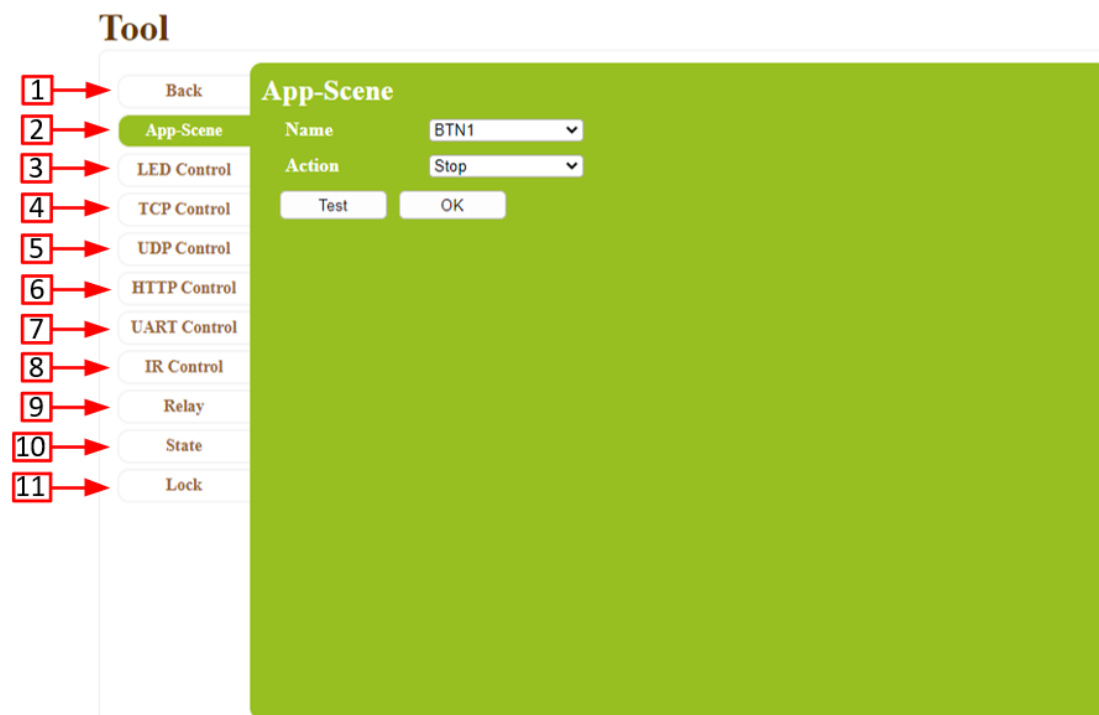

1. Click "Back" to return to the Scene Editing Page.
2. Click "App Scenes" to generate a start/stop scene command.
3. Click "LED Control" to generate a LED control command.
4. Click "TCP Control" to generate a TCP control command.
5. Click "UDP Control" to generate a UDP control command.
6. Click "HTTP Control" to generate a HTTP control command.
7. Click "UART Control" to generate a UART control command.
8. Click "IR Control" to generate an IR control command.
9. Click "Relay" to generate a Relay control command.
10. Click "State" to generate a status control command for a two-commands mode key.
11. Click "Lock" to generate a Keylock control command.

Scene Command Generation Tool (App-Scene)

Back

App-Scene

LED Control

TCP Control

UDP Control

HTTP Control

UART Control

IR Control

Relay

State

Lock

App-Scene

Name

BTN1

Action

Stop

Test

OK

1. Select the scene you want to stop or start.
2. Select whether to start or stop the scene.
3. Click "Test" to test the command.
4. Click "OK" to ensure that the command is generated and can be viewed in the command input box.

Scene Command Generation Tool (LED Control)

Back

App-Scene

LED Control

TCP Control

UDP Control

HTTP Control

UART Control

IR Control

Relay

State

Lock

LED Control

Button

BTN-1

Color

RED

Test

OK

1. Select the button you want to change the color.
2. Select the color.
3. Click "Test" to test the command.
4. Click "OK" to ensure that the command is generated and can be viewed in the command input box.

Scene Command Generation Tool (TCP Control)

1. Enter the IP address of the device to control.
2. Enter the Port number of the device to control.
3. Select the Feedback Button. (When the Feedback option is set to "ON" and it does not receive correct feedback from the controlled device after sending a message, the selected button will turn red).
4. Select whether you want to enable or disable the Feedback function.
5. When a message is received from a controlled device, the message is displayed here.
6. Enter the specified Feedback message. (Required only when the Feedback option is "ON").
7. Enter the instructions that should be sent to the destination IP address.
8. Put a check mark in this box if you need to send the instructions in HEX format.
9. Click "Test" to test the command.
10. Click "OK" to ensure that the command is generated and can be viewed in the command input box.

Scene Command Generation Tool (UDP Control)

1. Enter the IP address of the device to control.
2. Enter the Port number of the device to control.
3. Select the Feedback Button. (When the Feedback option is set to "ON" and it does not receive correct feedback from the controlled device after sending a message, the selected button will turn red).
4. Select whether you want to enable or disable the Feedback function.
5. When a message is received from a controlled device, the message is displayed here.
6. Enter the specified Feedback message. (Required only when the Feedback option is "ON").
7. Enter the instructions that should be sent to the destination IP address.
8. Put a check mark in this box if you need to send the instructions in HEX format.
9. Click "Test" to test the command.
10. Click "OK" to ensure that the command is generated and can be viewed in the command input box.

Scene Command Generation Tool (HTTP Control)

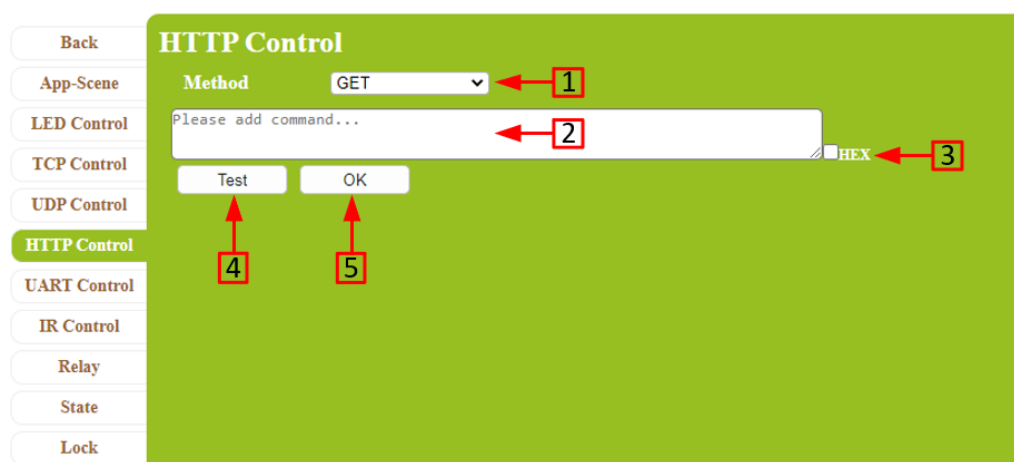

1. Select Get or Post instructions.
2. Enter the instructions to be posted or received.
3. Put a check mark in this box if you need to Post/Get the instructions in HEX format.
4. Click "Test" to test the command.
5. Click "OK" to ensure that the command is generated and can be viewed in the command input box.

Scene Command Generation Tool (UART Control)

1. Enter the IP address of the device to control.
2. Enter the Port number of the device to control.
3. Select the Feedback Button. (When the Feedback option is set to "ON" and it does not receive correct feedback from the controlled device after sending a message, the selected button will turn red).
4. Select whether you want to enable or disable the Feedback function.
5. When a message is received from a controlled device, the message is displayed here.
6. Enter the specified Feedback message. (Required only when the Feedback option is "ON").
7. Enter the instructions that should be sent to the destination IP address.
8. Put a check mark in this box if you need to send the instructions in HEX format.
9. Click "Test" to test the command.
10. Click "OK" to ensure that the command is generated and can be viewed in the command input box.

Scene Command Generation Tool (IR Control)

1. Select the IR Port (This model only has one port).
2. Learn or enter a specified infrared code.
3. Click “Learn-long” if you need to learn a long infrared code.
4. Click “Learn-short” if you need to learn a short infrared code.
5. Click “Test” to test the command.
6. Click "OK" to ensure that the command is generated and can be viewed in the command input box.

Scene Command Generation Tool (Relay Control)

The screenshot shows the 'Relay' control interface. The sidebar on the left is highlighted with the 'Relay' button. The main area has a green background and contains the following elements:

- Port:** A dropdown menu set to 'RELAY-1' (indicated by a red arrow and the number 1).
- State:** A dropdown menu set to 'OFF' (indicated by a red arrow and the number 2).
- Test:** A button (indicated by a red arrow and the number 3).
- OK:** A button (indicated by a red arrow and the number 4).

1. Select the Relay to control (This model has two Relays).
2. Select the relay state (On or Off).
3. Click “Test” to test the command.
4. Click "OK" to ensure that the command is generated and can be viewed in the command input box.

Scene Command Generation Tool (State)

This is an instruction for the Dual command mode (it only works if the button is set to Dual command mode). Use this command to change the state of the Dual-command button at will.

The screenshot shows the 'State' control interface. The sidebar on the left is highlighted with the 'State' button. The main area has a green background and contains the following elements:

- Button:** A dropdown menu set to 'BTN-1' (indicated by a red arrow and the number 1).
- State:** A dropdown menu set to 'ONE' (indicated by a red arrow and the number 2).
- Test:** A button (indicated by a red arrow and the number 3).
- OK:** A button (indicated by a red arrow and the number 4).

1. Select the button.
2. Select the state (One or Two).
3. Click "Test" to test the command.
4. Click "OK" to ensure that the command is generated and can be viewed in the command input box.

Scene Command Generation Tool (Lock)

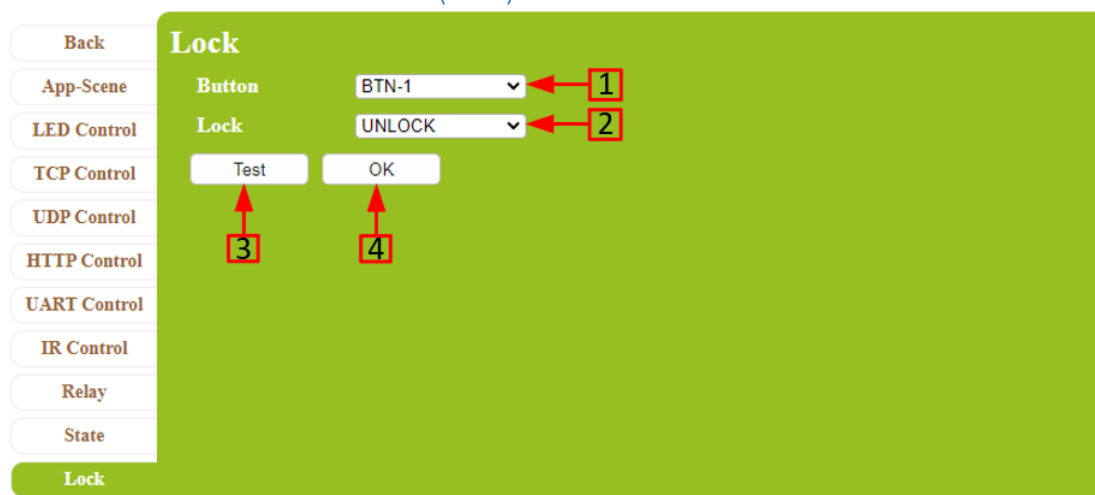

1. Select the button.
2. Select the state (Lock or Unlock).
3. Click "Test" to test the command.
4. Click "OK" to ensure that the command is generated and can be viewed in the command input box.

Backup and Restore Scenes

App-Scene

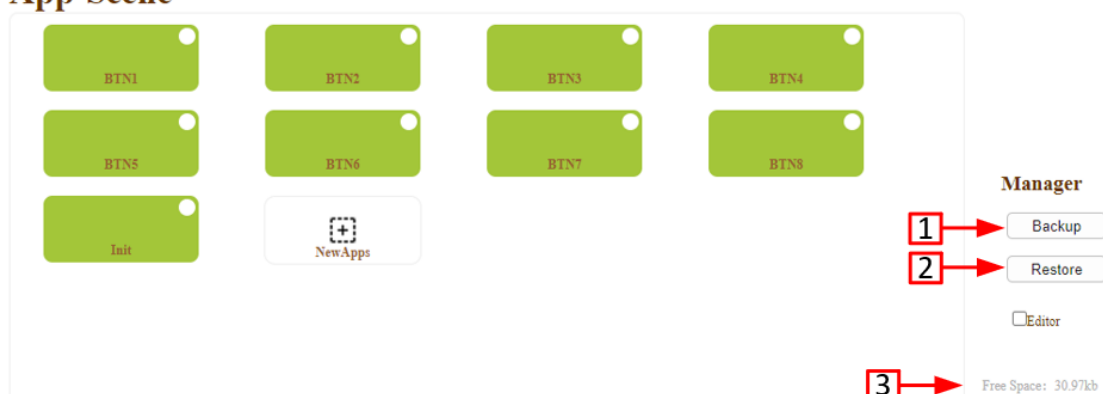

1. Click "Backup" to backup the scenario data to the local PC. The system will generate a backup.bin file.
2. Click "Restore" and select the backup.bin file to restore the scenario data. After the file is restored, the device automatically reboots.
3. Indicates the remaining storage space for scenes.

Update Firmware

Follow the steps below if a firmware update is required.

1. Connect a network cable to the device. Ensure that the PC and the device are on the same network segment. The default IP address of the device is 192.168.168.54
2. Access the web interface of the device and select the "SYSTEM" tab and then the "System Update" option.

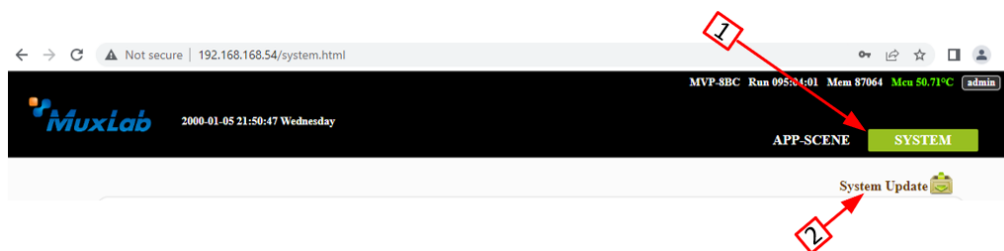

3. Enter the Username and Password and click "Update". After 10 seconds the system automatically enters Update Device mode.

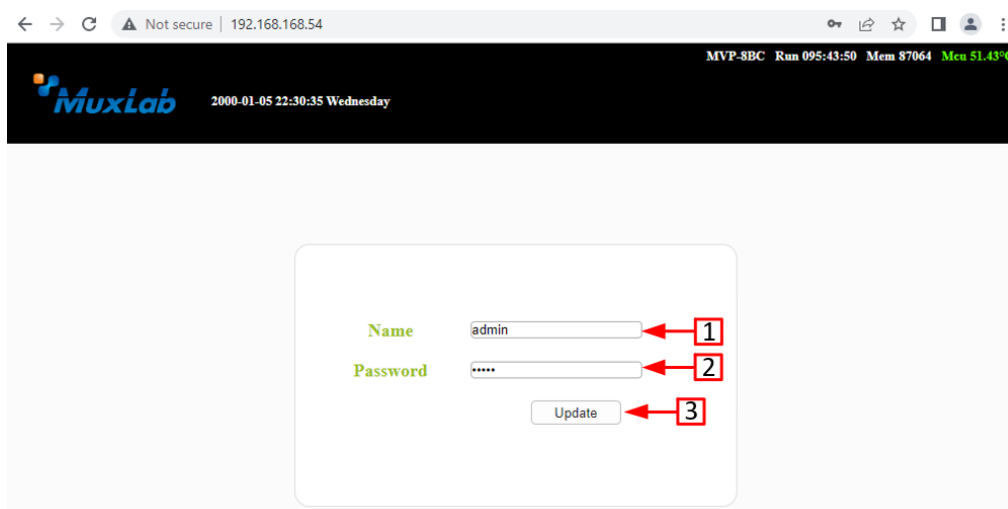

4. In Update device mode, click "Choose file" and select the .bin file, check the box "Update ok enter app" and click "Update". After the process is complete, the device will reboot and the web interface will open again.,

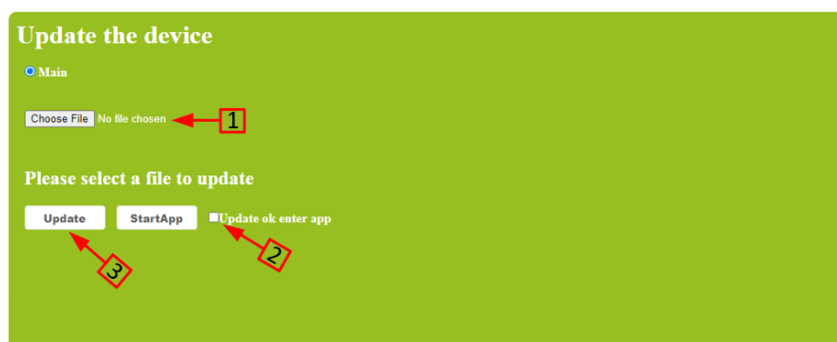
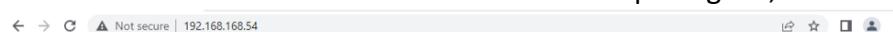

Safety Information



To reduce the risk of electric shock, do not expose this product to rain or moisture



Do not modify the wall plug. Doing so will void the warranty and safety features



If the wall plug does not fit into your local power socket, hire an electrician to replace the socket or purchase an adapter.



This equipment should be installed near the AC outlet and the device should be easily accessible in case power needs to be quickly disconnected.

Warranty

This product has a two (2) year warranty from the date of original purchase.

The warranty will be void if a serial number has been removed from the product.

Upon determination of a legitimate defect covered by this warranty and at MuxLab's sole discretion, the unit will be either repaired or replaced. The user must bear the transport cost to MuxLab, and MuxLab will bear the return cost of the shipment during the warranty period.

If product is out of warranty then a repair charge will be applicable. The repair cost will be determined on a case-by-case basis. MuxLab will repair the faulty out of warranty product after the repair cost has been approved by the Customer and proper financial arrangements are agreed upon. The customer must bear all shipment costs for out of warranty products, including to and from MuxLab.



MuxLab Inc.

2321 Rue Cohen

Montreal, Quebec

Canada H4R 2N7

Tel.: +1 (514) 905-0588 Fax: +1 (514) 905-0589

Toll Free (North America): 877 689-5228

URL: www.muxlab.com

E-mail: info@muxlab.com