

GHIEMMETTI

 Dante™

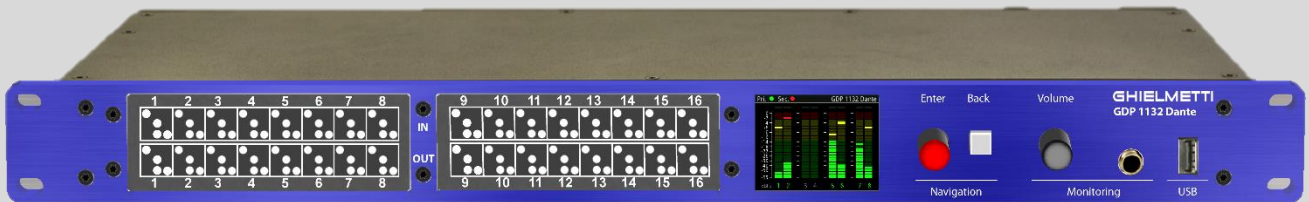

Digital Patch Bay **plus** for Dante™

GDP 1132 Dante

Manual

Edition 09/2020

Contents

1	Introduction	4
2	General description.....	5
2.1	Housing.....	5
2.2	GDP 1132 Dante - System.....	5
2.3	Block diagram.....	6
2.4	Functionality.....	6
3	Installation and Start-up.....	7
4	Manual operation on device	8
4.1	Controls.....	8
4.1.1	Navigation – Navigation knobs	8
4.1.2	Functions.....	8
4.1.3	Ghielmetti connection G3P patch bay and patch cords.....	9
4.2	Navigation in the menu.....	9
4.2.1	System Menu.....	9
4.2.2	Menu tree	10
4.3	Boot screen.....	11
4.4	Meter Mode	11
4.5	Menu - Main Menu	12
4.6	Menu – Meters.....	13
4.7	Menu - Mixer	14
4.8	Menu – Audio Network	15
4.9	Menu – Info.....	17
4.10	Menu – Configuration	19
4.10.1	Configuration – Audio.....	19
4.10.2	Configuration – Display inactivity	20
4.10.3	Configuration – Network.....	20
4.10.4	Configuration – Language.....	20
4.10.5	Configuration – Advanced.....	21
4.10.6	Configuration – Restore / backup settings.....	21
4.11	Software Update.....	22
5	Web Application.....	23
5.1	Main screen with Live View.....	23
5.2	Main screen with configuration.....	25
5.2.1	Audio Input to Dante Output Mixer.....	26
5.2.2	Dante Input to Audio Output Mixer.....	27
6	Technical data	28

1 Introduction

GDP 1132 Dante is a digital patch bay for analog audio signals in a Dante Network. It uses Ghielmetti's known G3P technology.

GDP 1132 Dante can be operated directly with its front elements on the device and remotely through a WEB browser for monitoring meters. The device has a separate LAN/Ethernet port for remote viewing or for updating software.

In order to guarantee a high level of reliability, the device can be operated with redundant power supplies.

The appropriate choice of high quality materials such as aluminium front panel, a modern device design and well thought-out and stable functionality should place the device in the professional audio segment.

2 General description

GDP 1132 Dante consist of a Dante part with a Brooklyn II and analog inputs and outputs. The audio signals between Brooklyn and analog modules are routed through a mixer. This enables the system to mix several Dante channels onto one analog output or several analog channels onto one Dante output.

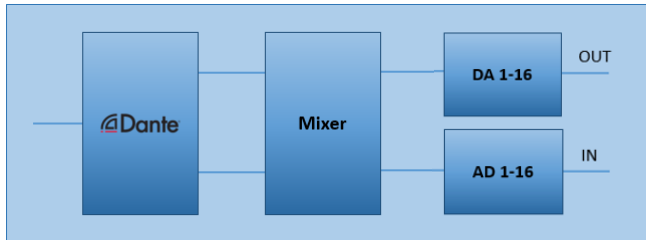

Simplified operating diagram

2.1 Housing

GDP 1132 Dante is a 19", one rack unit device with steel and aluminium body, its assembly depth is 220 mm. Its dimensions therefore make it very interesting for its use in tight spaces, such as OB-Vans.

Front side:

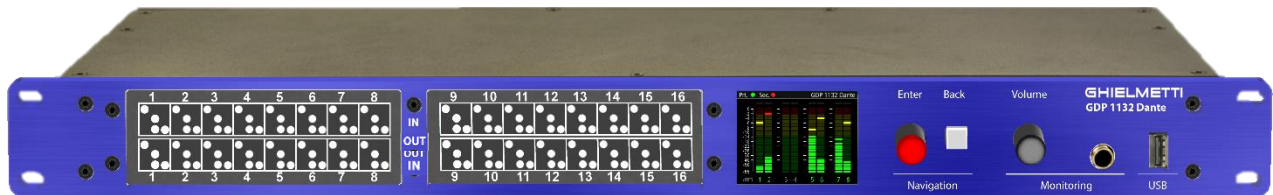

Back side:



2.2 GDP 1132 Dante - System

« GDP 1132 Dante -System» includes the GDP 1132 Dante - **Hardware** (Embedded Hardware), GDP 1132 Dante - **Firmware** (Embedded Software) and GDP 1132 DANTE-**Web-GUI-Software** (Internet-Browser-Web pages).

2.3 Block diagram

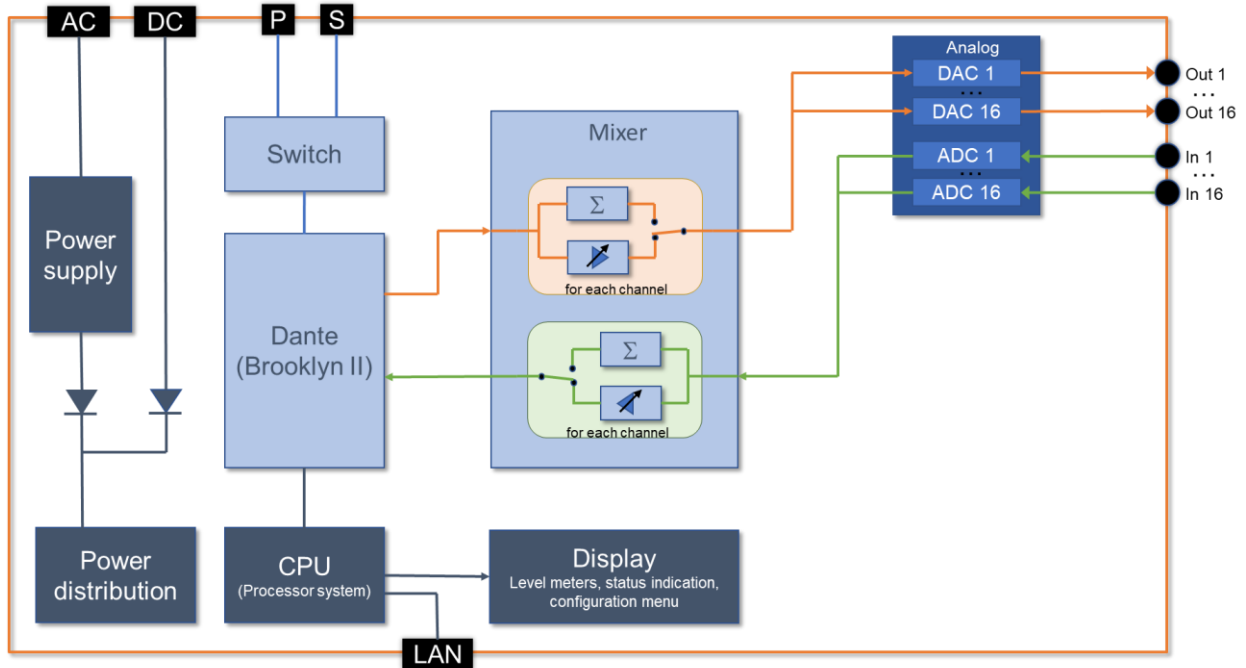

2.4 Functionality

The device offers 16 analog inputs and 16 analog outputs which can be connected via a mixer with 32 Dante inputs and 32 Dante outputs.

The analog inputs and outputs can be connected using the patch panel on the front. The device shows the level of the signals on the patch panel via a built-in display as well as on an external monitor via a web browser.

The signals can be monitored using headphones or the AES3 output.

The mixers can be configured and the channels can be monitored locally on the device as well as via a web browser.

3 Installation and Start-up

For installation plug-in the main supply and connect to the Dante-Network. After connecting the device the system will start automatically. At system start-up, the device will connect to the Dante network and all active channels will be displayed.

GDP 1132 Dante can be set-up locally or remotely over the web browser (use Google Chrome for best performance).

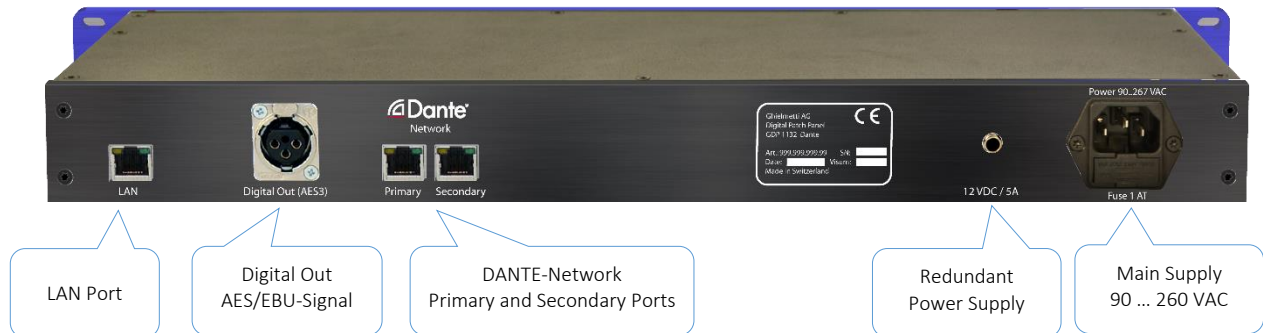
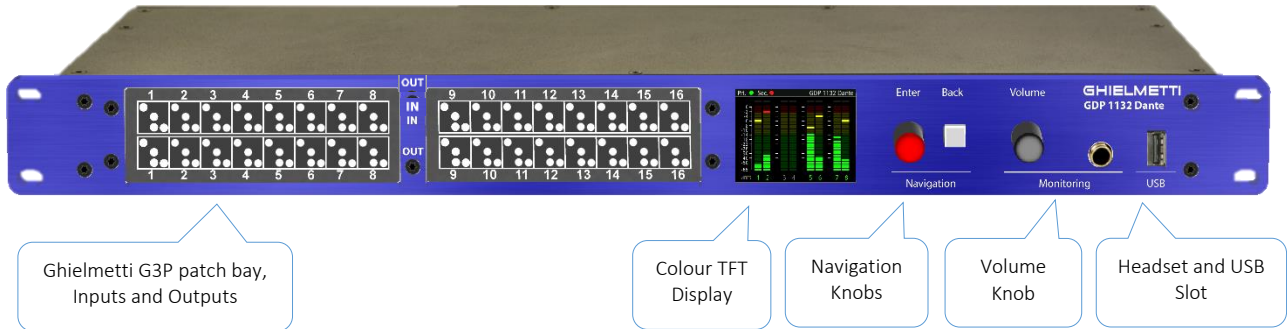

4 Manual operation on device

4.1 Controls

The device has a 2.2" display for local operation and display of the audio level.

4.1.1 Navigation – Navigation knobs

As an interface to the GUI use the knob with push function (enter) or the button (back) right next to the screens on the right side.



4.1.2 Functions

Enter Knobs	Turn clockwise	<ul style="list-style-type: none"> - Menu navigation up - Increase the value
	Turn counter clockwise	<ul style="list-style-type: none"> - Menu navigation down - Decrease value
	Press (normal)	<ul style="list-style-type: none"> - Call up the menu - Select menu item - Accept value - Switching between mono / stereo when a level meter is selected
	Press (long)	<ul style="list-style-type: none"> - Call up the menu
Back	Press (normal)	<ul style="list-style-type: none"> - Menu back - Leave current screen
	Press (long)	<ul style="list-style-type: none"> - From any screen / menu back to home screen
Volume	Turn clockwise	<ul style="list-style-type: none"> - Increase the volume of the headphones and AES3 monitoring (when not fixed) - Adjusting the balance towards the right channel
	Turn counter-clockwise	<ul style="list-style-type: none"> - Decrease the volume of the headphones and AES3 monitoring output (when not fixed) - Adjusting the balance towards the right channel
	Press (normal)	<ul style="list-style-type: none"> - Mute headphones and AES3 output
	Press (long)	<ul style="list-style-type: none"> - Switching between setting volume and setting balance

4.1.3 Ghilmetti connection G3P patch bay and patch cords

With the Ghilmetti patch cords, the patch bay gives you the ability to physically patch Dante channels assigned in the GDP 1132 Dante unit.

Patch cords are available in different lengths and colours, we also offer Ghilmetti G3P to XLR adapters. For more information, do contact us or visit our website, www.Ghielmetti.ch.



4.2 Navigation in the menu

The following overview illustrates navigation in the System menu:

4.2.1 System Menu

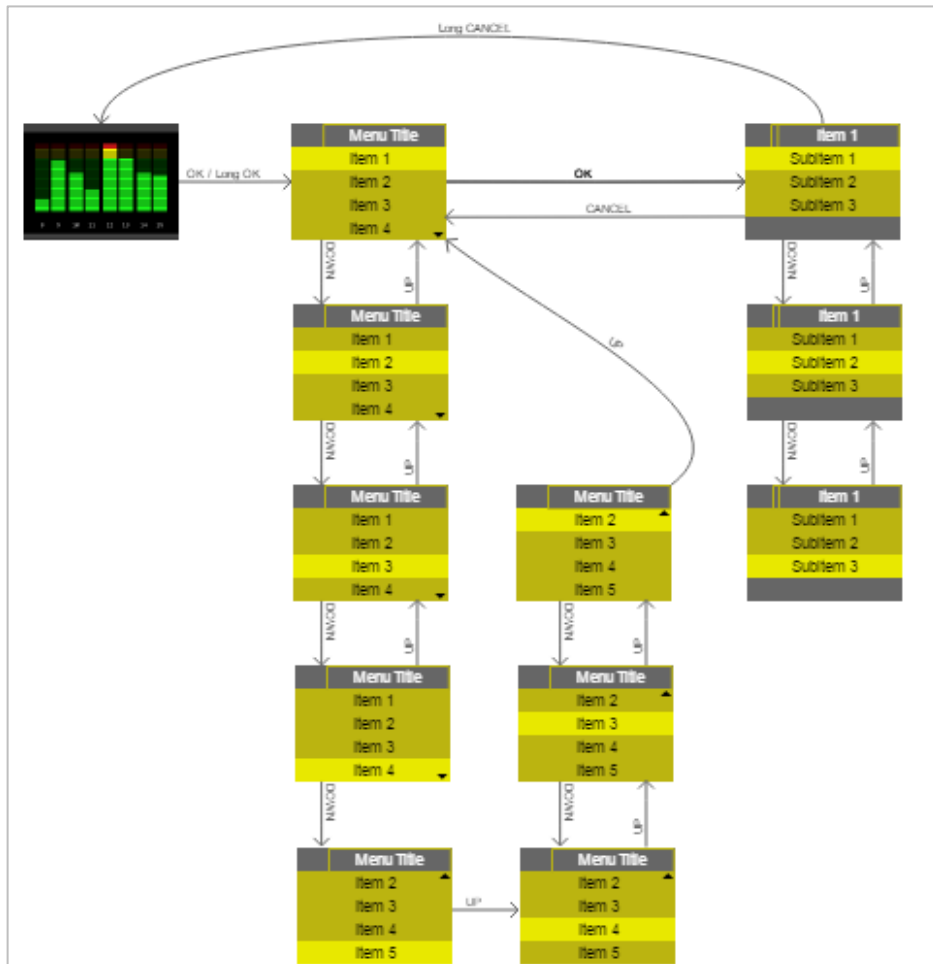

4.2.2 Menu tree

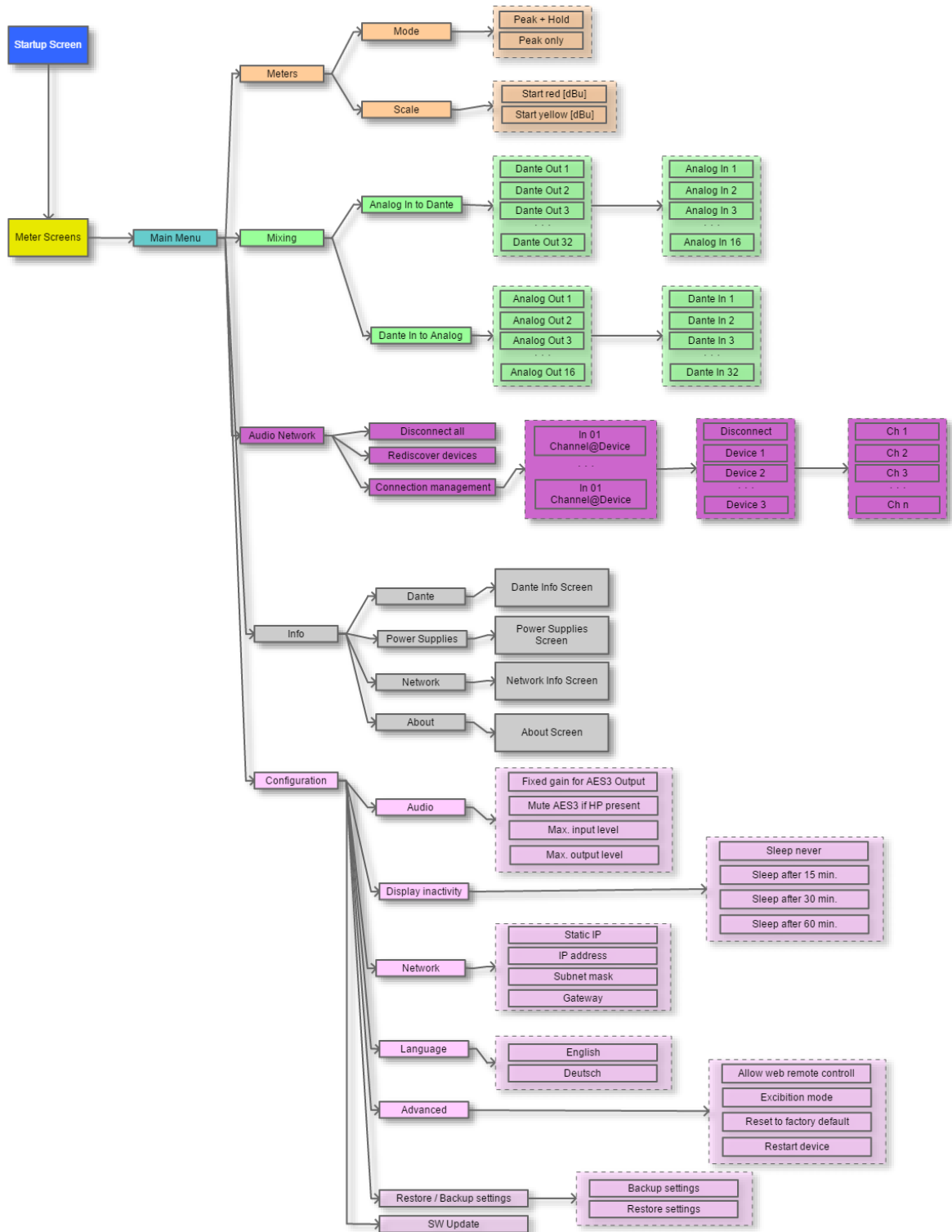

4.3 Boot screen

This screen is displayed while the system is starting up. During the system initialisation, the screen can also briefly go dark or white.

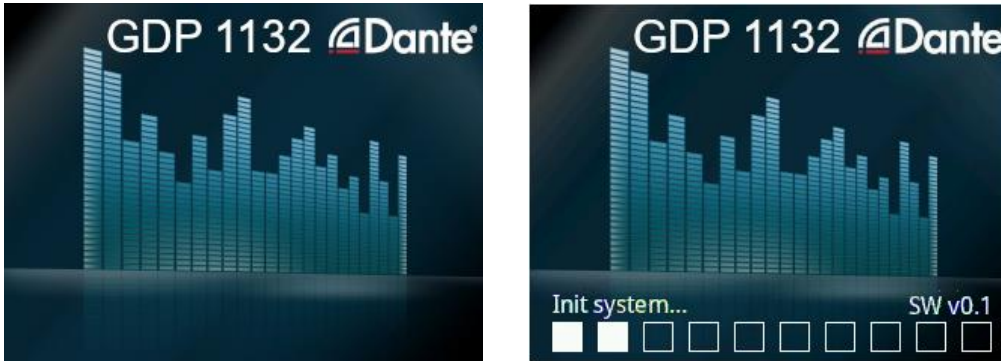

When the application is started and initialised, a progress bar and the software version appear on the start screen. The start screen has a timeout of 10s. When the Dante module is ready, the start screen will be exited and the device will switch to meter mode.

4.4 Meter Mode

In normal operation, the device is in meter mode and shows the level of the audio signals on the patch panel.

For metering of the 16 channels, you can turn the knob to the right, the channels will scroll in the screen. In case you call-up the settings menu of the device, this will be shown on the screen hiding the channel monitoring.

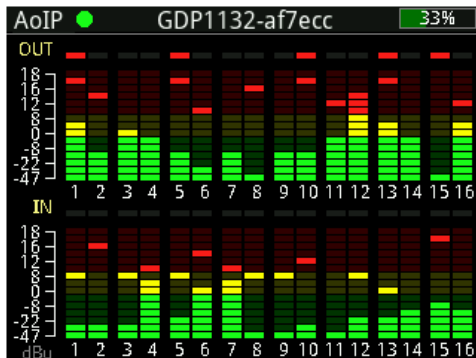

AoIP : Status of the Dante network

- **Green** : primary and / or secondary network available
- **Yellow** : No Dante network available
- **Gray** : No communication with the Dante module in the device

GDP1132-xxxxxx : Dante device name

nn% : Current headphone volume. If the volume bar is gray 33%, the output is muted. This is done by pressing Volume.

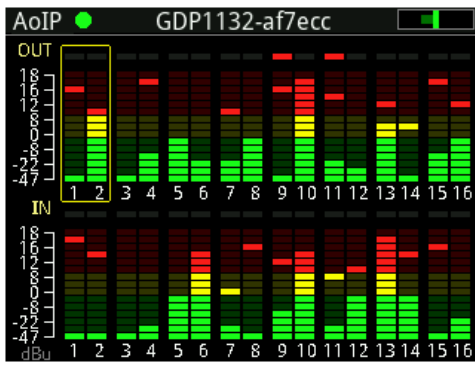

The level display corresponds to the levels set in the menu. Depending on the set max. level for inputs or outputs (18dBu or 24dBu) a different scale is used for the levels.



The channel to be monitored can be selected with the Navigation knob. By pressing the Navigation knob, the selection is switched between mono and stereo.

Volume and balance can be adjusted using the Volume knob.

With a long click on Volume knob you can switch between the volume setting and the balance setting.

If the balance is in the middle position, this is indicated by a dark green middle bar . If the balance is outside the middle position, the middle bar becomes light green and a dark green bar appears in the direction in which the balance is off-set .

4.5 Menu - Main Menu

The menu has the following structure:

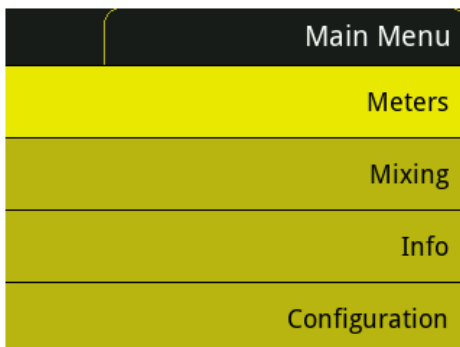

Meters : Settings for display and mode of the level meter

Mixing : Settings for mixer (Analog In to Dante and Dante In to Analog)

Info : Information about the device, Dante network and local network

Configuration : Various settings of the device

4.6 Menu – Meters

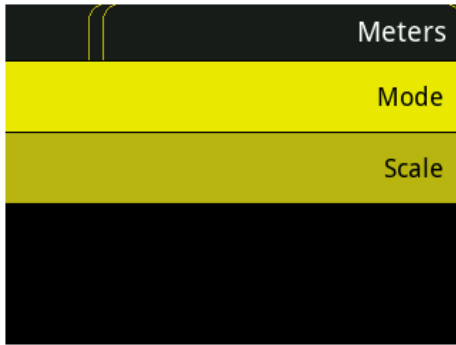

The meter configuration menu is divided into different categories (Mode and Scale).

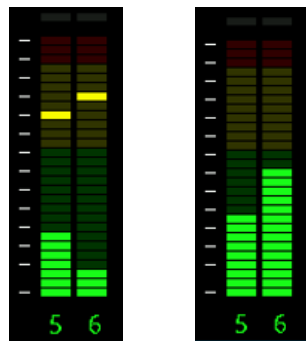
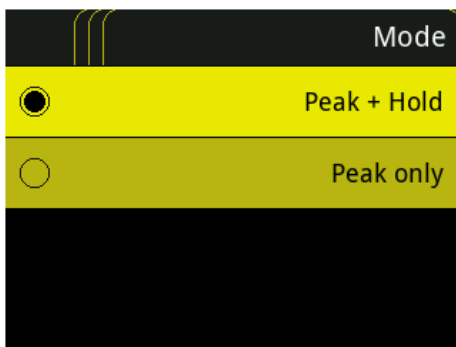

Lagging display of the peak value versus only display of current value.

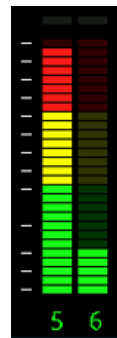

Configuration of the level ranges which are displayed in red or yellow on the level meters.

By selecting with Enter, a dialog appears in which the value can be changed:

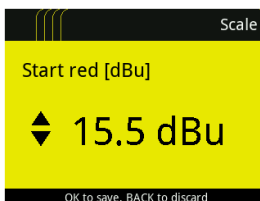

4.7 Menu - Mixer

Setting the mixer.



There are basically 2 mixer functions:

Analog In to Dante: Several analog inputs from the patch panel can be mixed to any Dante output.

Dante In to Analog: Several Dante inputs can be mixed to any analog output on the patch panel.

Basic setting:

- Analog In 1 (patch panel) to Dante output 1
- Analog In 2 (patch panel) to Dante output 2
- ...
- Dante input 1 to analog output 1 (patch panel)
- Dante input 2 to analog output 2 (patch panel)
- ...

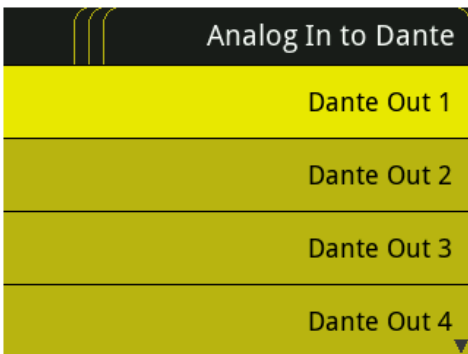

Selection for which Dante output mixer should be configured.

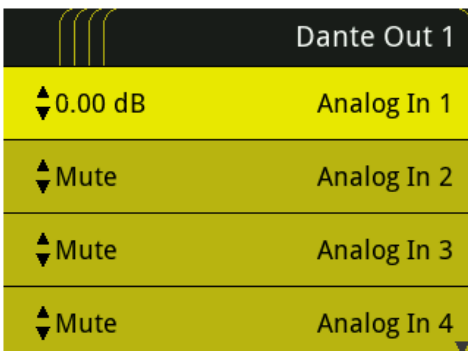

Setting the mixer for Dante output. Each analog input can be mixed to a Dante output with a separate volume setting. Mute means no mixing on the output.



Selection for which analog output mixer should be configured.

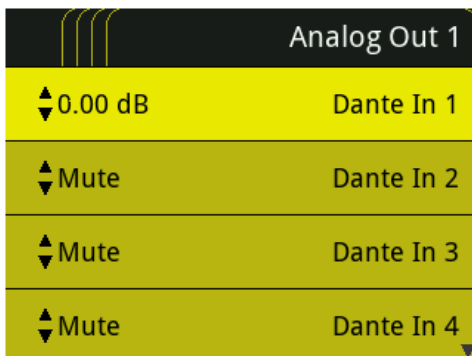

Setting the mixer for analog output. Each Dante input can be mixed to an analog output with a separate volume setting. Mute means no mixing on the output.

4.8 Menu – Audio Network

This menu is used to establish connections in the Dante network. If more extensive configurations have to be made in the Dante network, the Dante controller should be used.

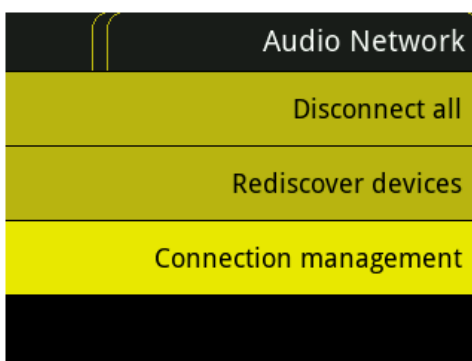

Deletes all connections from the GDP 1132 Dante to devices in the Dante network.

Starts a new search for devices in the Dante network.

Deletes or creates a connection between an input channel of the GDP 1132 Dante and an output channel of a device in the Dante network.



Every change that affects the Dante network must be confirmed in an additional dialog. If the change is not desired, the action can also be canceled with 'Back'.

Establish connections to the Dante network:

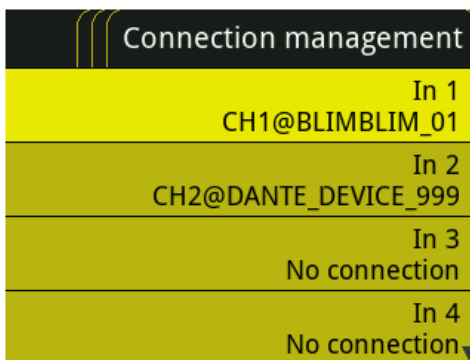

To create or delete a connection, an input channel must first be selected from the GDP 1132 Dante. For each connection channel it is also displayed whether it already has a connection (channel @ device) or not (No connection).

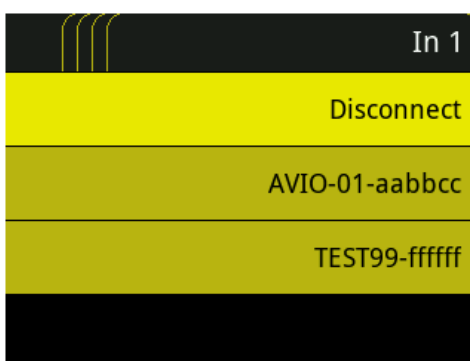

The following can now be selected for the selected input channel:

- Disconnect - to disconnect (if connection was available)
- Dante device to which a connection shall be established

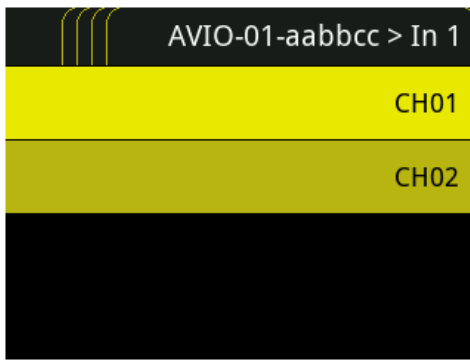

The channel to which a connection shall be established can now be selected for the selected Dante device.

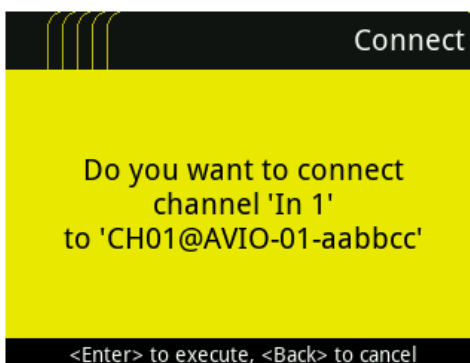

A summary of the action is displayed in the confirmation dialog (in this example the channel In 1 is connected to channel CH1 from the Dante device AVIO-01-50767b).

To establish the connection, "Enter" must then be selected. "Back" means discarding the action.

4.9 Menu – Info

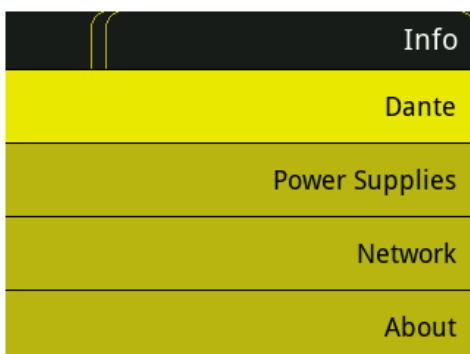

Menu for device information divided into different categories.

Dante Info	
Dante module	Brooklyn II
Dante SW Ver.	4.2.0.28
Brooklyn App Ver.	99
Product Version	0.0.2000
Module name	GDP1132-af7ecc
Primary IP	205.205.205.205
Primary link speed	0
Primary IP	205.205.205.205
Primary link speed	0
Network state	Link down
Dante state	Not Ready

Information on Dante and the Dante module used (Brooklyn II).

Power Supplies	
Power supply 1	11.99 V
Power supply 2	11.99 V

Current voltage values of internal supply (Power Supply 1) and external supply (Power Supply 2).

Network info	
Address type	DHCP
IP address	192.168.1.61
Subnet mask	255.255.255.0
Gateway	192.168.1.1
MAC number	7C:8B:CA:03:FE:E1

Network information for LAN connection. This IP address can be used to access the device via a web browser.

About	
Device name	GDP 1132 Simu
Mainboard	SW 0.1 HW 0
Front 1	SW 0.0 HW 0
Mixer	V0 (00.00.00)
Module 1	16AOUT - HW 1
Module 2	16AIN - HW 1
	none

General device information such as software and hardware versions.

4.10 Menu – Configuration

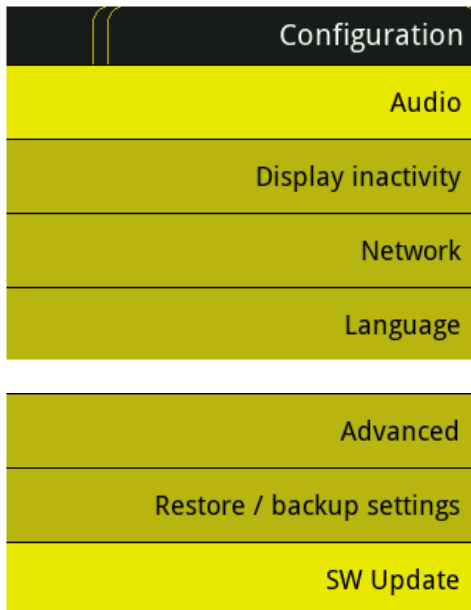

Menu for general device configuration divided into different categories.

4.10.1 Configuration – Audio

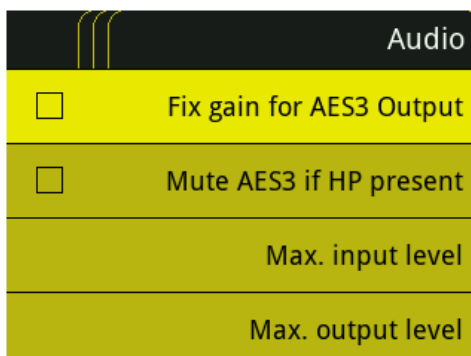

Fixed volume for AES3 monitor output and mute AES3 switched off.

AES3 is muted when headphones are plugged in.

Max. Input and output level:



This setting sets the 0 dBFS equivalent: A setting of 18 dBu means that 0 dBFS signal levels on the digital side correspond to 18 dBu on the analog side.

4.10.2 Configuration – Display inactivity

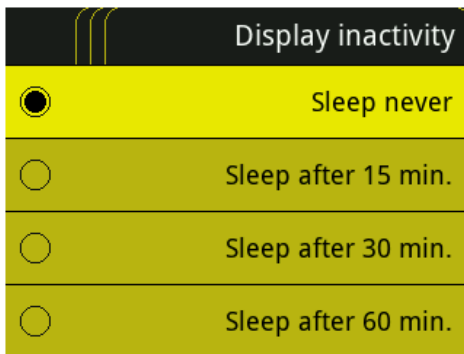

After a set time (or never) the display switches off if no activity takes place on the device.

As soon as an activity is carried out (e.g. rotary wheel navigation) the display is switched on again.

4.10.3 Configuration – Network

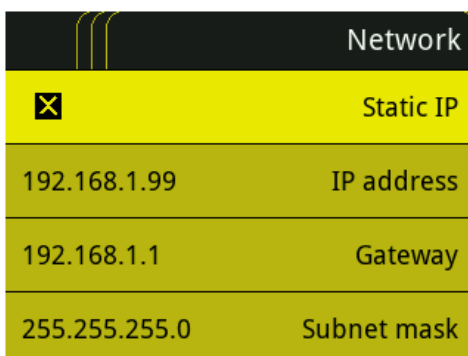

Network settings for the LAN port.

By default, the device is set to DHCP so that the device is automatically assigned an IP address by a DHCP server.

4.10.4 Configuration – Language



Setting the language for the device.

4.10.5 Configuration – Advanced



Allows or blocks operation of the device via the web application.



The device has an Exhibition mode in which the audio meters are controlled with random values. This can be particularly helpful if the device is presented at an exhibition.

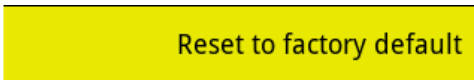

Resets all settings to default values.



Restarts the device.

4.10.6 Configuration – Restore / backup settings



When restoring, you can choose from a list of available backup settings on the USB stick:



Saves settings on a USB stick or restores settings from a USB stick. The menu is only displayed if a USB stick is inserted.

Settings are saved on the USB stick under the following name:
 DDMMYYYY-hhmmss_gdp.db3 Example: 25082020-161543_gdp.db3

If the restore is selected, the device will restart after reading the settings from the USB stick.

4.11 Software Update

If a USB stick with a new update file and the associated update script (everything in the root directory of the USB stick) is inserted, an additional menu item "SW Update" is displayed under Configuration.

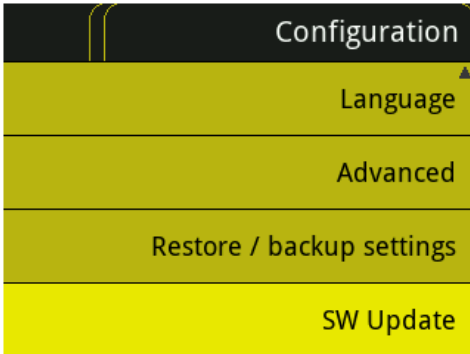

Inserted USB stick with update software is selectable



Display of software available on the USB stick.



If an entry is selected from the list, the software update starts.
 Attention: There is no query whether the update should really be started.

After the software update is completed, the device will restart.

5 Web Application

A connection to the device can be made using a web browser (Google Chrome preferred). Access is enabled directly via the IP address of the GDP 1132 Dante.

5.1 Main screen with Live View

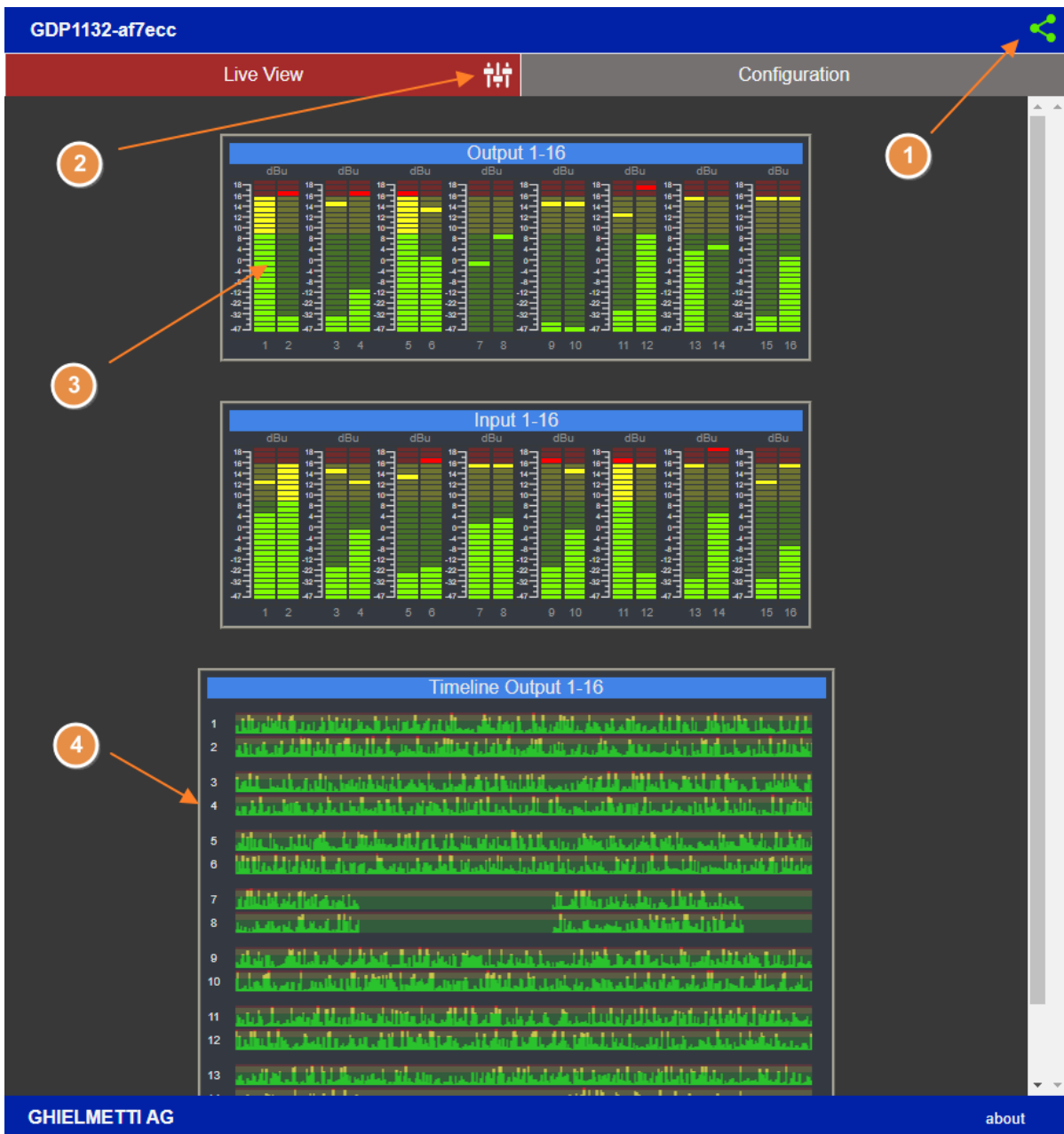

Both the channel to be monitored and the volume on the device can be set via the browser:

1

The symbol indicates the Dante status:

- Gray : Dante module (Brooklyn II) not ready or no communication with the software
- Yellow : Dante module ready but no network connection
- Green : Dante ready (network via primary or secondary connection)

2 Clicking on this symbol opens a settings window for the Live View:

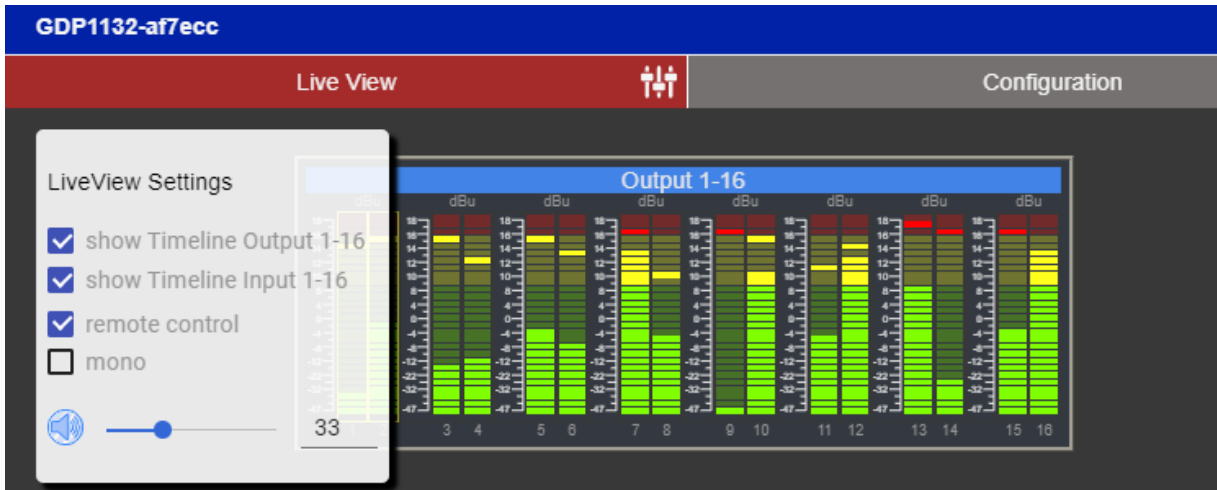



- Timeline view can be switched on for both the inputs and the outputs
- If the setting "Allow Web Remote Control" is activated on the device, the remote control function can be switched on for the web browser to select channels for listening, to change the volume or to switch between mono / stereo
- Mono / stereo switching for the channel to be monitored
- Volume of the channel to be monitored for headphones and AES3 output

3 The channel to be monitored can be selected in the level view using the mouse. The levels displayed correspond to the levels on the patch panel.

4 Timeline view. The duration of the timeline can be set in the configuration up to 45 seconds.

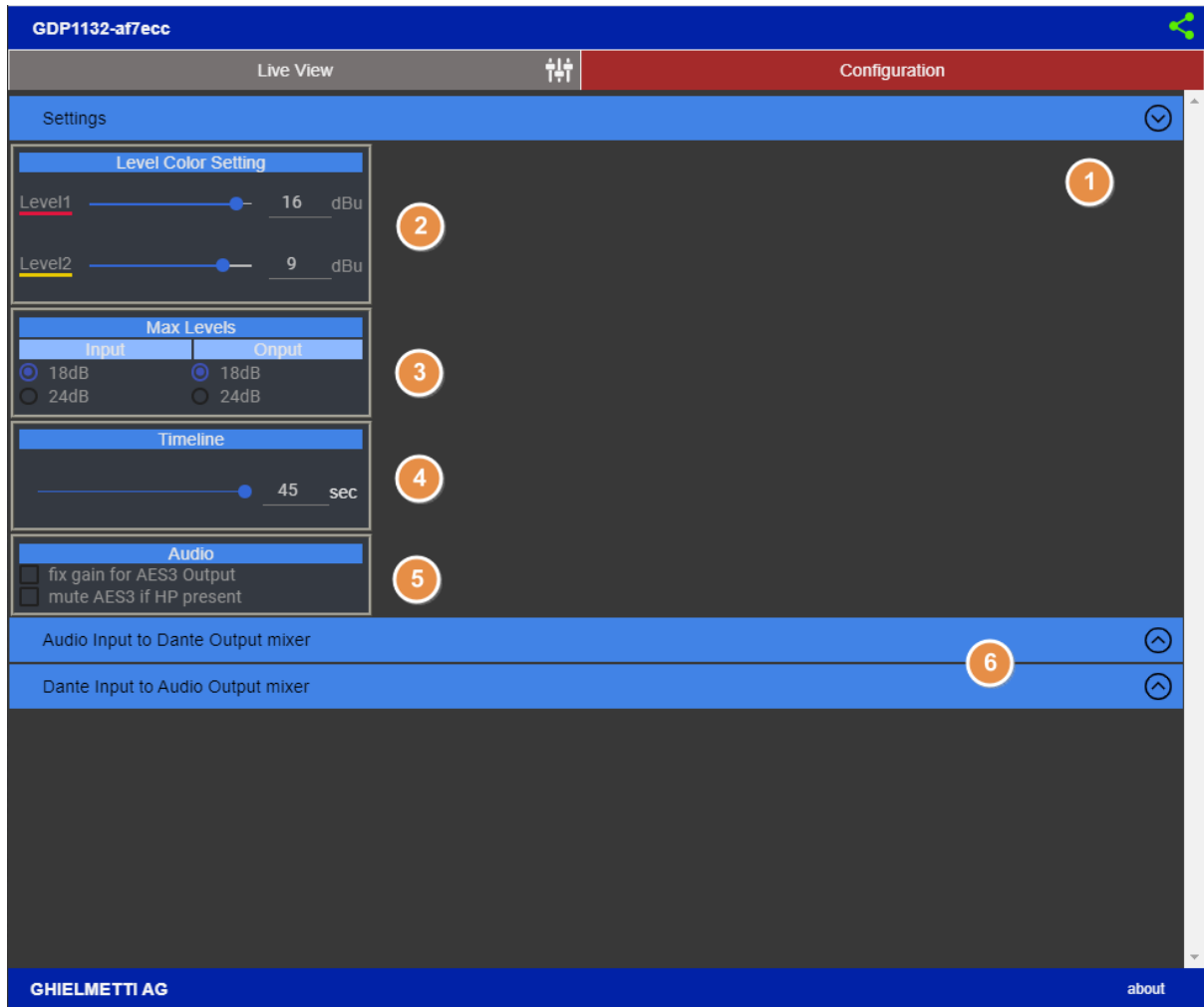
5.2 Main screen with configuration



- 1 A configuration group can be expanded by clicking on .
- 2 Configuration of the color change at level display in Live View.
- 3 Max. Level (0 dBFS equivalent) individually adjustable for the outputs and the inputs.
- 4 Recording duration for the timeline view.
- 5 Fixed gain (0 dB) for the AES3 output and mute the AES3 output when the headphones are plugged in.
- 6 Setting the mixer
 - Mixing of 16 analog input channels to 32 Dante output channels
 - Mixing of 32 Dante input channels to 16 analog output channels

5.2.1 Analog Input to Dante Output Mixer

Configuration matrix to route the analog inputs to the Dante outputs.

Dante Output channels	Input 1	Input 2	Input 3	Input 4	Input 5	Input 6	Input 7	Input 8	Input 9	Input 10	Input 11	Input 12	Input 13	Input 14	Input 15	Input 16
1	0															
2		0														
3			0													
4				0												
5	-70	-50	-40	-20	0											
6						0										
7							0									
8								0								
9									0							
10										0						
11											0					
12												0				
13													0			
14														0		
15															0	
16																0
17																
18																
19																
20																
21																
22																
23																
24																
25																
26																
27																
28																
29																
30																
31																
32																

- 1 Dante output or output from the mixer.
- 2 Analog input or input to the mixer.
- 3 Volume (in dB) at which the input signal is mixed on the mixer. Standard green (0) means no mix (mute is achieved at volume <= -80 dB). The lighter the green is, the higher the mixed-in volume is.
- 4 Marking of a mixer or Dante output. If this mark is clicked, the mixer opens for this Dante output or mixer.

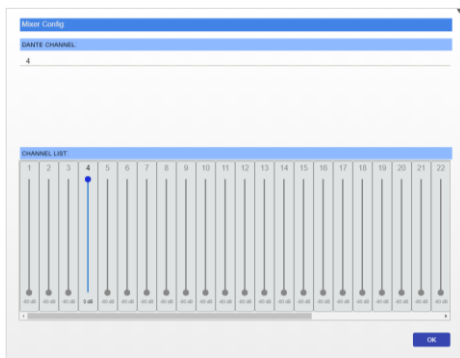

Values can be accepted with 

By selecting , the dialog is exited without accepting new values. Fine adjustment (0.5 dB steps) of the controller can be done by turning the mouse wheel with the controller selected.

5.2.2 Dante Input to Analog Output Mixer

Configuration matrix to route Dante inputs to analog outputs.

Dante Input channels	Output 1	Output 2	Output 3	Output 4	Output 5	Output 6	Output 7	Output 8	Output 9	Output 10	Output 11	Output 12	Output 13	Output 14	Output 15	Output 16
1	0															
2		0		0												
3			0													
4				0												
5				-23	0											
6				-41		0										
7				-60			0									
8				-73				0								
9									0							
10										0						
11											0					
12												0				
13													0			
14														0		
15															0	
16																0
17																
18																
19																
20																
21																
22																
23																
24																
25																
26																

- 1 Dante input or input to the mixer. If there are Dante connections from this device to other Dante devices, this information is also displayed.
- 2 Audio output or output from the mixer.
- 3 Volume (in dB) at which the input signal is mixed on the mixer. Standard green (0) means no mix (mute is achieved at volume <= -80 dB). The lighter the green is, the higher the mixed-in volume is.
- 4 Marking a mixer or audio output. If this mark is clicked, the mixer opens for this audio output or mixer.

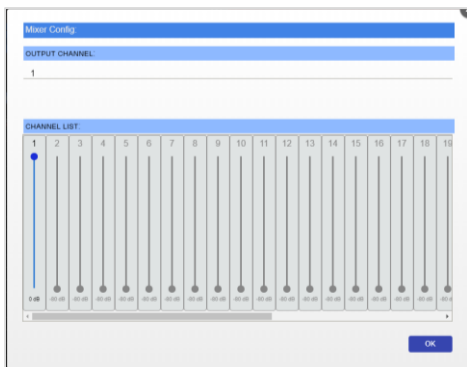

Values can be accepted with 

By selecting , the dialog is exited without accepting new values. Fine adjustment (0.5 dB steps) of the controller can be done by turning the mouse wheel with the controller selected.

6 Technical data

General data	
Supply 1	IEC connector 90 VAC... 260 VAC, 47... 63 Hz 50VA, 0.8A
Supply 2 (redundant)	DC Jack (2.5 x 5.5mm) 12V / 5A
Operating temperature	0 °C ... 45 °C
Storage temperature	-20 °C ... 55 °C
Housing	19 "(482.6 mm), 1 U (44.1 mm), depth 220 mm Housing made of steel, front and rear panels made of aluminium
Display	TFT LCD (2.2 ", 320x240 pixels, 65k colors)
Fan	Temperature controlled
Weight	3.2 kg

Analog inputs (patch panel)	
Connector system	Ghielmetti G3P
Signal	Symmetrical
Input impedance	20k Ω
Max. Input level (0 dBFS reference level)	+ 18dBu or + 24dBu (switchable from software)
Latency	< 400us (12/fs @ ADC + 7/fs @ Mixer)
Converter / amplifier	CS5368 / OPA2134 + OPA1632
Frequency response	-0.07 dB (20 Hz) / 0.03 dB (20 kHz)

Analog outputs (patch panel)	
Connector system	Ghielmetti G3P
Signal	Symmetrical
Output impedance	100 Ω
Applicable load impedance	\geq 2k Ω
Max. Output level (0 dBFS reference level)	+ 18dBu or + 24dBu (switchable from software)
Latency	< 500us (17/fs @ ADC + 7/fs @ Mixer)
Converter / amplifier	PCM3168 / OPA2134 + DRV135
Frequency response	-0.02 dB (20 Hz) / 0.05 dB (20 kHz)

Monitoring - headphones	
Plug	1/4" Phone Stereo Jack (6.35mm)
Output power	Max. 0.1W RMS pro Canal

Monitoring - AES3 output	
Plug	XLR (male)
Signal	Stereo, symmetrical
Output impedance	110Ω

Mixer	
Matrix	64 x 64
Latency (In to Out)	< 150us (7 / fs)
Resolution	0.5 dBFS between 0 and -80 dB

Connections	
Local LAN	1x 100Base-T
USB	USB 2.0 Typ A

AoIP (Audio Over IP)	
Technology	Dante
AoIP module	Audinate Brooklyn II 64x64
Connections	2x 1G Ethernet (primary and secondary)
DDM (Dante Domain Manager) Ready	Yes
Firmware Update	Using the Dante Controller
Inputs	32 Dante inputs • Can be mixed to 16 analog outputs
Outputs	32 Dante outputs • Can be mixed to 16 analog inputs

