

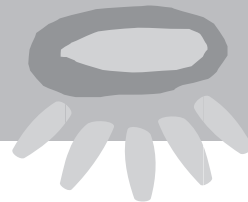

# MANUAL



# CM4



## Introduction

Please read this manual before using the product in order to give you the needed product and installation instruction to assure a seamless installation and non compromised overall sound quality.

Thanks for purchasing our APart CM4 speaker, a small sized ceiling mount speaker. The APart CM4 has been especially designed and engineered in our Belgian head quarters for low ohmic systems where voice and music reproduction are of greatest importance. The 4inch speaker has been developed in order to deliver a wide dispersion angle in order to reduce the amount of needed speakers. The voice coil with a 16Ohm impedance allows you to use 4 speakers in parallel on one 4 ohm capable amplifier channel. When using our APart Concept-1 amplifier you have the ability to use 2 zones of each 4 speakers or one stereo/mono zone with up to 8 APart CM4speakers. The build in filter ensures long life of the speaker and enhances the speaker-response. This speaker is straight forward: connect and play while no need to worry about filtering.

## Safety precaution

- Keep this manual for future reference.
- Clean only with dry cloth
- When making the hole in your ceiling to mount the APart CM4, make sure there is sufficient clearance behind the ceiling (no obstructions like A/C channels, power lines etc.,)
- Take care of your speaker wires, they should be free of damage. Damaged speaker wires might result in poor sound quality and can damage amplifiers.
- Only use accessories specified by the manufacturer
- Make sure the ceiling can support the speakers weight.
- Use sufficient amount of speakers to avoid death-spots.

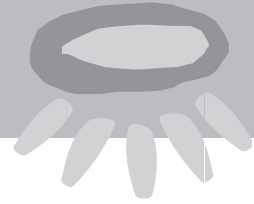

- No main power shall be connected to the loudspeakers, doing so will damage the speaker.
- This apparatus should only be serviced by qualified personnel. If not warranty might be void.
- The speaker grill is fixed, removing it will damage the speaker.
- Use cable of the right gauge, certainly for long runs.
- Use cables with clear color indication and maintain polarity throughout the whole system.
- Avoid loud feedback from microphones, this can damage your speaker.
- Please check the units condition after unpacking. If the outside of the carton box has been damaged, inform your shipper immediately.
- Take notice that this speaker is intended for indoor use only. Do not expose the speaker to rain or moisture.

## Features and benefits

- The Acoustical metal can improves overall sound response and protects against falling debris.
- Suitable for high quality crystal clear audio thanks to the correction network, acoustical can and non compromised speaker.
- Only 100mm mounting depth, so it can be used in a wide variety of applications and wide range of ceiling materials.
- The strong retention spring system enables sufficient strength to allow very thin ceiling material.
- 16Ohm voicecoil allows to connect up to 4 APart 16-Ohm capable speakers to each 4Ohm stable amplifier channel.

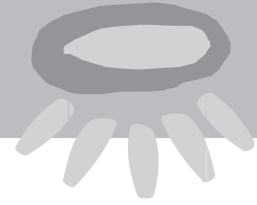

## Using the cutout template

Note: when making the hole in your ceiling, double-check if there are no cables or any other obstruction behind the ceiling. Cutting in the ceiling without this check might result in damaged infrastructure and even damaged power lines.

1.

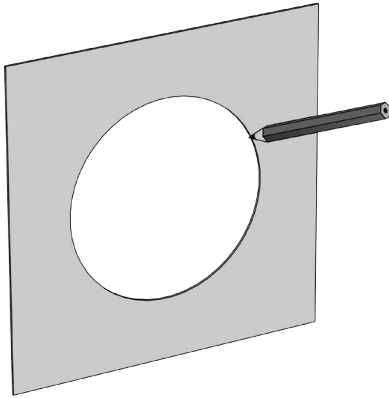

2.

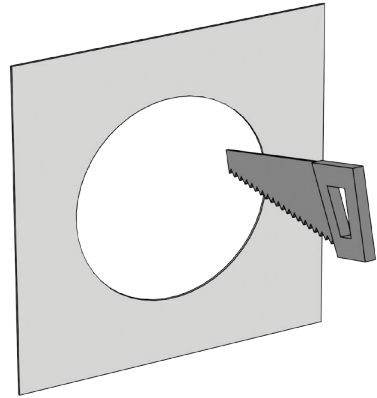

3.

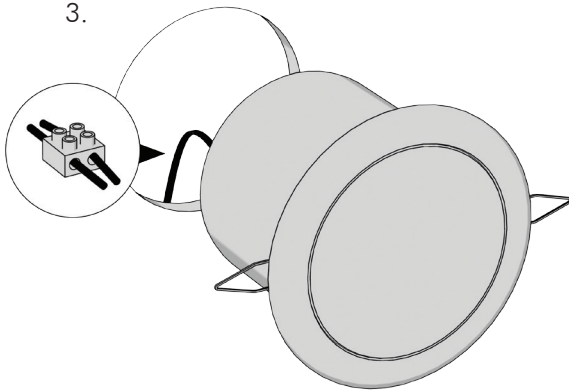

4.

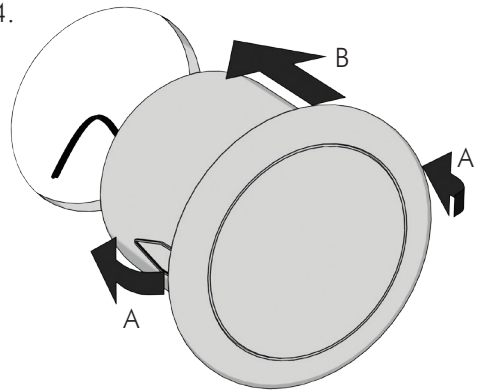

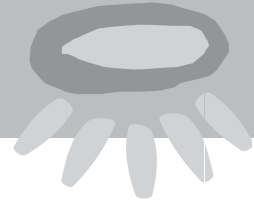

## Connecting the speaker

Use the correct polarity when daisy chaining speakers ! When a mistake occurs in your daisy chain, it can severely impact speaker performance as there will be audio-cancellation.

The daisy chain options are endless and the setup will depend on the capabilities of your amplifier. Make sure when daisy chaining speakers that the total impedance is not lower than the lowest specified impedance of your amplifier. Not following this rule might result in distorted sound and might even damage your amplifier.

Series wiring speaker diagram:

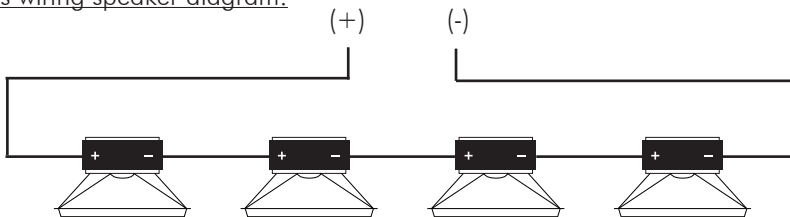

$$\text{Total resistance} = R1 + R2 + R3 + R4 + \dots$$

Parallel wiring speaker diagram:

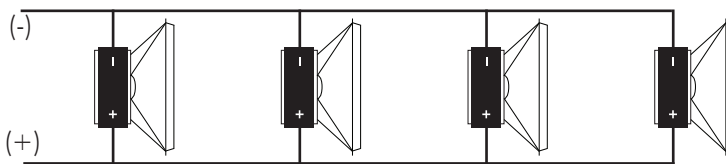

$$\text{Total resistance} = \frac{1}{1/R1 + 1/R2 + 1/R3 + 1/R4 + \dots}$$

R1 = Resistance of speaker 1

R2 = Resistance of speaker 2

R3 = Resistance of speaker 3

R4 = Resistance of speaker 4

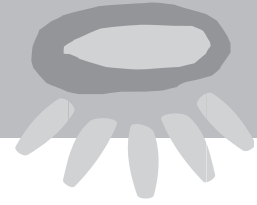

## Using the CM4 together with a Subwoofer

For speech and background music, the CM4 is highly suitable in stand alone operation, for optimum and full bodied music we advice to add one of our subwoofers to your system, like the CMSUB8 or SUBTILE.



The APart CMSUB8 stereo ceiling subwoofer is designed to reproduce a fat and deep bass.

Featuring dual 8 ohms coils and incorporated passive filter circuitry, the CMSUB8 can be used in almost any situation where extra bass is needed at low to medium sound levels and where interior decoration does not permit the installation of a subwoofer cabinet.

The APart SUBTILE subwoofer is designed to combine a strong, deep bass with a discrete design and small dimensions. It is very easy to integrate even in the most demanding environments.

You can use it lying flat on the floor under furniture, hidden under a bench, behind curtains, or wall-mounted using the included brackets. SUBTILE may look like a small heating radiator when mounted to the wall, but instead of heat, it will radiate musical vibes in your room!



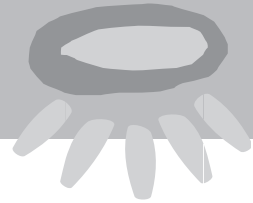

## Specifications

Type	CM4
Woofers	4inch, dual cone coated paper
Shape	round
Rated power RMS	15W / 16Ohm
Music power RMS	30W / 16Ohm
Frequency response	100Hz to 20kHz +-3dB
Dispersion at 1kHz, 4kHz, 8kHz	180°, 80°, 40°
Color	White
Chassis type	Full metal chassis
Grill construction	Metal
IP class	50
Protected against falling debris	yes, by backside can
Fixing type	2 high strenght springs
Cut out dimension	115mm
Outside dimension	135mm
Depth dimension	100mm
Max wire size diameter	2,5mm <sup>2</sup>
Net weight	0,785Kg
Gross weight	0,925Kg

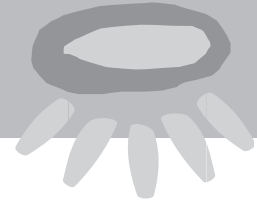

**Polar diagram 1000 Hz**

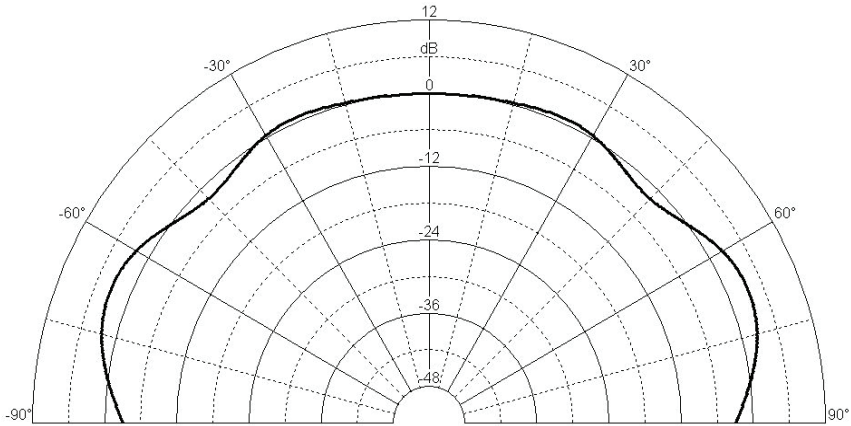

**Polar diagram 2000 Hz**

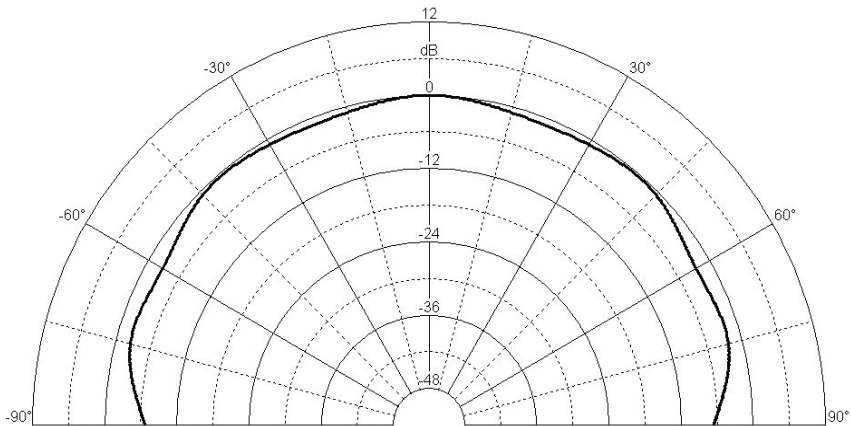



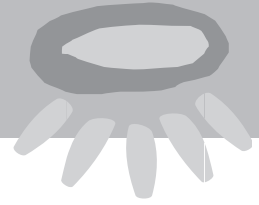

## Polar diagram 4000 Hz

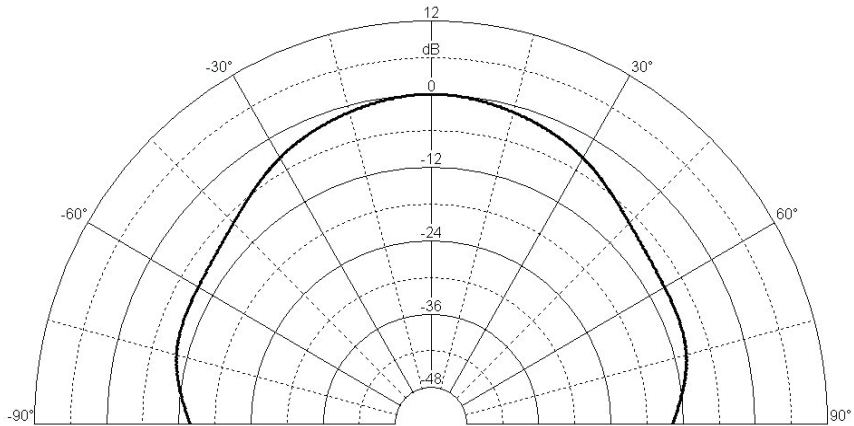

## Polar diagram 8000 Hz

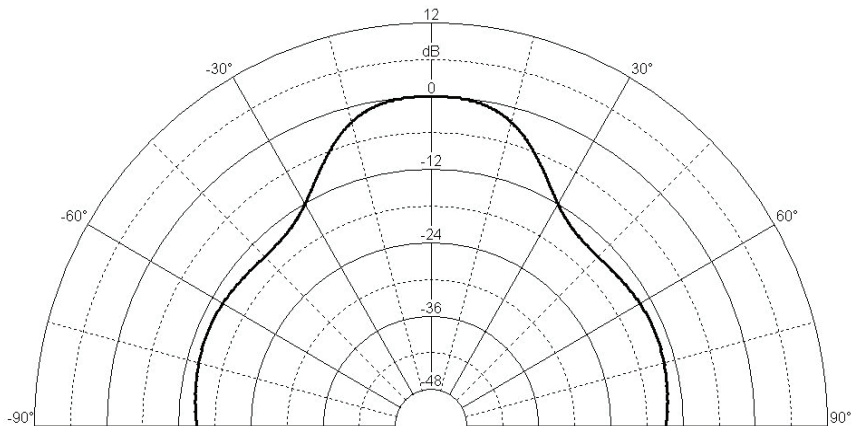

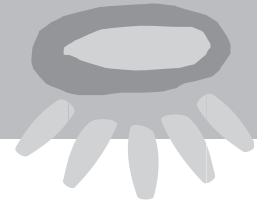

## Technical drawing with measurements

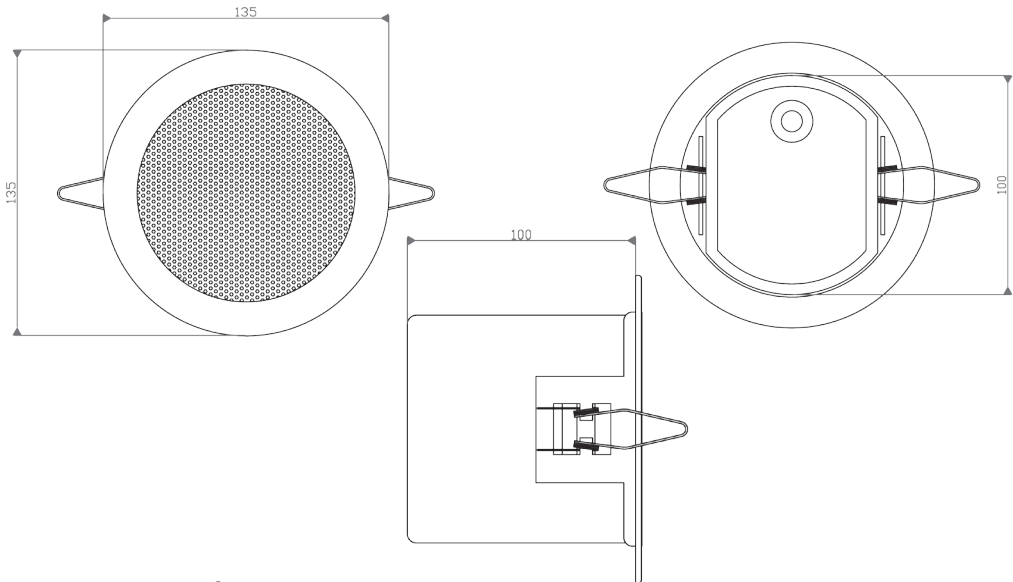

## Warranty info

APart-Audio warrants this product to be free of defects in material and workmanship for a period of one year for parts and for a period of one year for labor from the date of original end-user purchase. This warranty is valid only for the original end-user and cannot be transferred.

During the warranty period APart-Audio or one of its authorized service partners shall either repair or replace any product, free of charge, that proves to be defective on inspection by APart-Audio or its authorized service representative.

This warranty does not include, damages or product faults due to abuse, misuse or faulty installation.

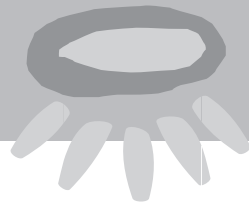

## Notes

---

---

---

---

---

---

---

---

---

---

---

---

---

---

---

---

---

---

---

---

---

---



**ANY SUGGESTION?**

***They are well appreciated and eventually rewarded!  
Send your ideas or suggestions to***

***suggestions@apart-audio.com***

*Company names, product names, and names of formats etc. are the trademarks or registered trademarks of their respective owners.*

*© 2010 APart-Audio specifications subject to change without notice.*

**developed by**

**Audioprof nv  
Industriepark Brechtsebaan 8 bus 1  
2900 Schoten  
Belgium**

