

HLS-2B

Hearing Loop

Driver

Installation &

Commissioning

Handbook

AMPETRONIC

Listen to the difference

HLS-2B HANDBOOK

Handbook Contents

- Safety
- Introduction
- Quick Start
- Installation
- Troubleshooting
- Technical Specification
- Warranty
- Declaration Of Conformity
- Accessories

Box Contents

- 1 x HLS-2B
- 1 x P-Clip 3.2mm
- 1 x P-Clips 5.0mm
- 1 x P-Clips 6.5mm
- 3 x M3 x 6 PAN Screws
- 1 x A6 Deaf Logo
- 1 x Installation Handbook



This symbol is used to alert the user to important operating or maintenance instructions.



The Lightning bolt triangle is used to alert the user to the risk of electric shock.

SAFETY

1. It is important to read these instructions, and to follow them.
2. Keep this instruction manual in an accessible place.
3. Do not install this equipment near any heat sources such as radiators, heating vents or other apparatus that produces heat.
4. **WARNING: THIS APPARATUS MUST BE EARTHED.**



5. The HLS-2B is designed to be permanently connected apparatus and must be installed with all applicable installation regulations. A readily accessible all pole mains disconnect device shall be incorporated in the building installation power wiring.
6. The apparatus should not be exposed to dripping or splashing and should have no objects used for storing liquids placed upon it.
7. Mount the HLS-2B with the wiring entering from the side of the unit. Position cables in a neat manner, and tighten the P-Clips to ensure the cables are fully restrained. The cables should be positioned in such a manner that any liquid spilled on to them will not run into the unit. Cable access is via 3 cable entry points on the end of the unit. If the installation cables do not fill the entry hole or any hole isn't used then the hole should be masked such that any gaps are <4mm wide.
8. Do not mount the unit with the battery terminals facing downwards.
9. Refer all servicing and installation to qualified personnel.
WARNING: Isolate AC power externally before servicing or replacing fuses.
10. The amplifier generates some heat during normal operation and needs adequate ventilation. It should not be fitted in a fully enclosed space.
11. The battery should not be exposed to heat, sunshine or fire.



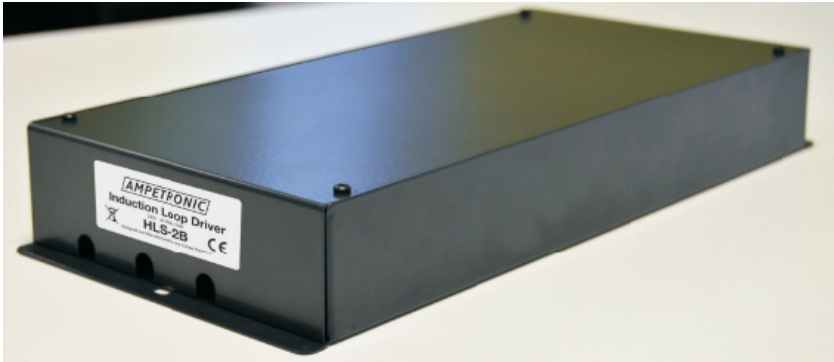

INTRODUCTION

The HLS-2B has been designed as a high quality stand-alone induction loop driver for use in small to medium size lifts, although the rugged construction may be suited to other industrial applications.

The unit is designed to drive a loop constructed out of custom built metal bars, which is a very low impedance. Ordinary wire can sometimes be used if it can be installed inside the lift car, but care must be taken to ensure the loop satisfies the unit's load requirements.

All versions have:

- two separate audio inputs,
- 230V or 115V AC power supply (factory set option)
- transformer coupled loop output.

The standard unit has two low-Z speaker line level input.

All connections (except the 'Protective Earth Terminal') are via vibration-resistant cage clamp terminals which are quick and easy to connect.

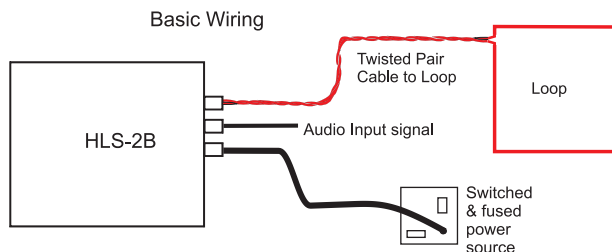

QUICK START

1. Fit HLS-2B on top of lift where it will not be vulnerable to damage and where the cables will be protected.
2. Fit loop cable / bars (refer to fitting section)
3. Ensure loop is insulated from lift body.
4. Connect loop to amplifier using feed cables. Ensure feed pair is twisted together.
5. Connect Signal Inputs (see input connection drawings) using twisted pair cable. Connect the positive battery terminal. Connect AC power (see points 5 and 9 in Safety section)
6. Connect AC power (see points 5 and 9 in Safety section)
7. Turn IN1, IN2, MLC and 'CURRENT' controls fully anticlockwise (minimum)
8. Apply an input signal (e.g. intercom). Increase the input control until the Green 'Compression' LED begins to light.
9. Repeat item8 for the second input (if used). Only apply one audio signal at a time when setting up the system.
10. Adjust the CURRENT control until the Yellow 'Loop Current' LED lights at peaks in the input signal. NOTE: Once the CURRENT control is set, do not adjust it again.
11. Adjust the MLC control to give the best clarity of sound.
12. Listen to the loop.

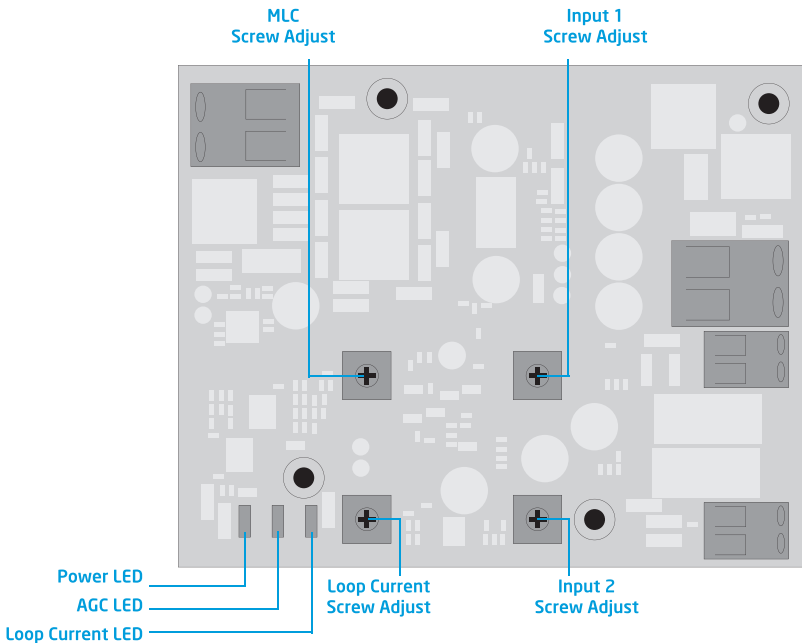

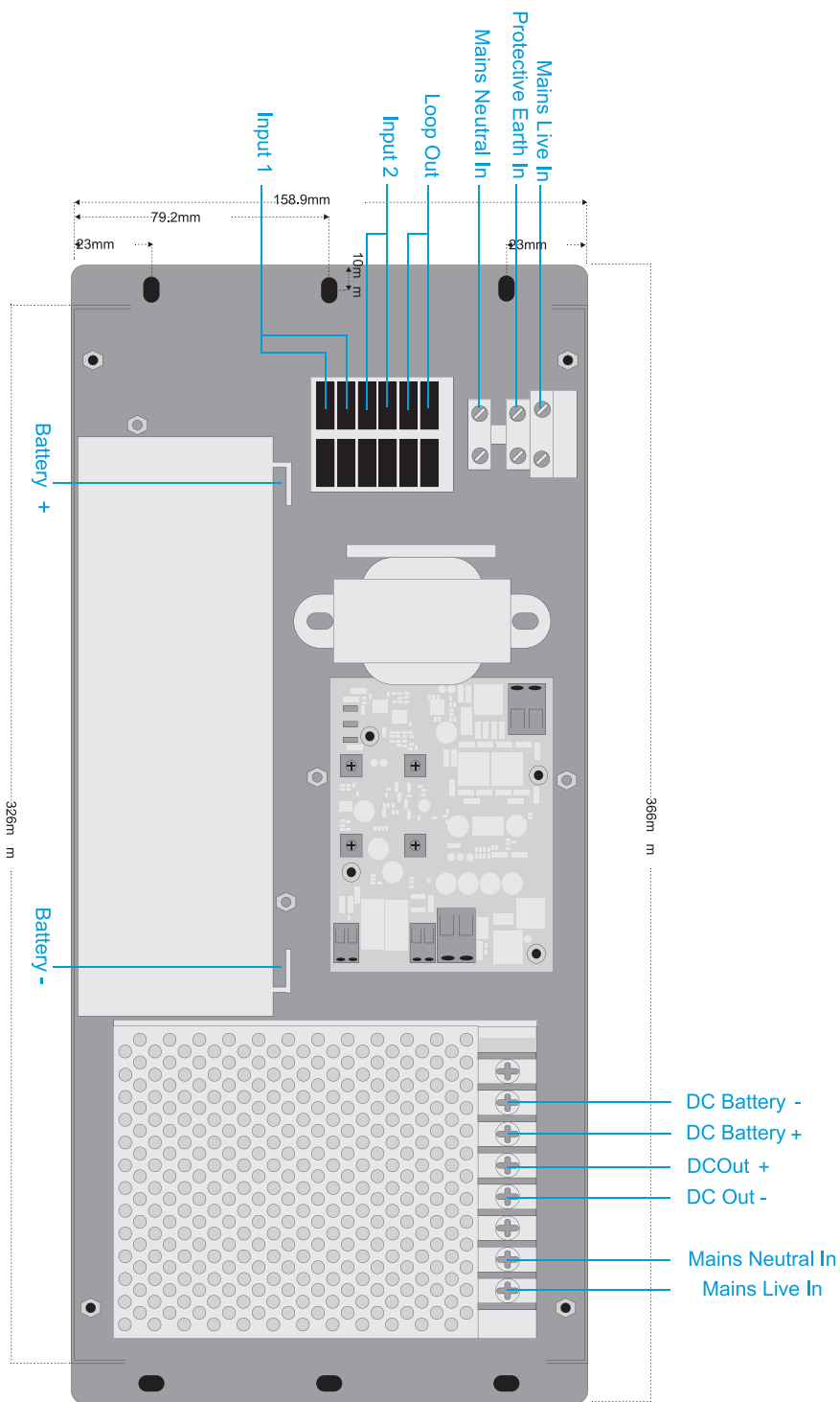

Inputs

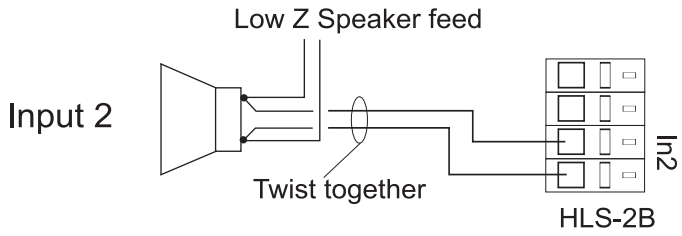
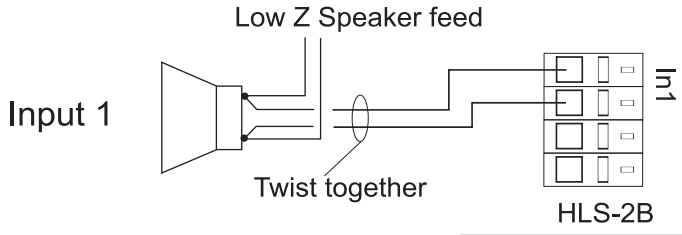

Block Diagram

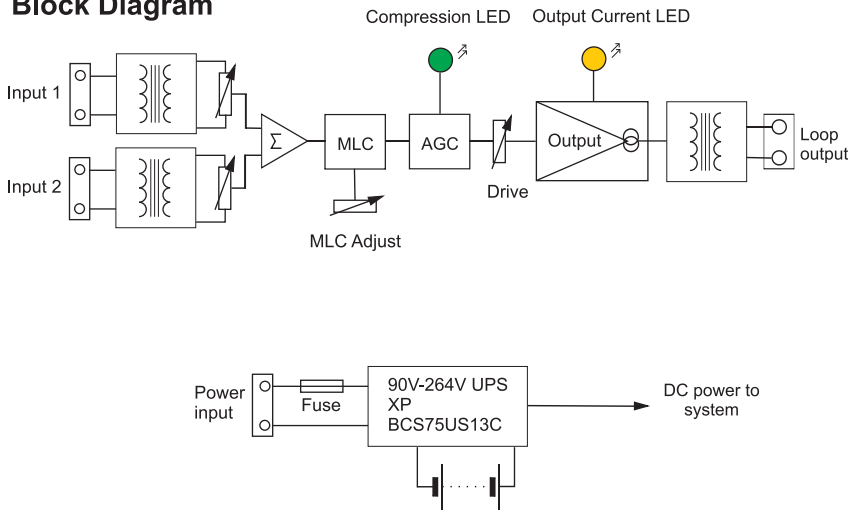

INSTALLATION

Tools

You will require the following:

- Phillips screwdriver
- Small flat blade screwdriver
- Ratchet crimp tool

Location

The amplifier should be mounted where :

- it is protected from drips or sprays of water
- it is not vulnerable to mechanical damage
- the controls can be accessed through the open cover.

The unit must be close to the loop; when used on a lift, it is typically mounted on top of the lift car.

Connections



GENERAL: Open the cage clamp terminals using a flat bladed screwdriver. See Layout drawing for location of each terminal and details of its operation.

LOOP: Connect the loop cable ends to the loop output connector. make sure that the feed cable (the 2-wire section between the amplifier and loop) is tightly twisted together and less than 3m in length. In lifts, the loop connecting wires should not be less than 2.5mm² (AWG 12) area. See below for loop design

INPUTS: Connect inputs as shown in the diagram.

For all inputs, use twisted pair cables, preferably with screen.

AC POWER: The HLS-2B can be supplied in 115VAC or 230VAC versions.

Check that the version you have is compatible with your power supply.

Isolate external AC power source before working on power connections

Connect incoming AC Earth to the 'Protective earth terminal'. See **SAFETY** notes 4 & 5.

Connect the incoming Live and Neutral to the relevant terminals, as marked.

Loop Design

The loop installed in the lift car needs to be designed and fitted correctly if the system is to be effective.

Most lifts are built with metal walls and ceilings. Because of the shielding effect of the metal 'box' in such lifts, the loop cable needs to be on the INSIDE of the car. This is normally achieved by constructing a special loop from metal bars fixed to, but insulated from, the ceiling. (This can be supplied by Ampetronic).

If the ceiling is not metal, or a suitable hidden location can be found inside a metal lift car, normal insulated wire of 2.5 mm² or 4 mm² can be used.

The connection from the loop to the equipment should be made using two 2.5 mm² wires twisted together.

TROUBLESHOOTING

For correct operation, you should have the following LEDs illuminated

Power (Green)

Compression (Green) only whilst audio signal is applied to an input

Loop Current (Yellow) only at peaks of audio signal

Power LED not illuminated

Battery discharged and external AC mains supply off - turn on external AC mains supply to charge battery and to operate unit.

Compression LED not illuminated at any time

No inputs connected - connect an input as described above

Relevant IN control not turned up far enough - adjust control as appropriate

Input signal level too low - check that input signal is >120mVrms for Lo-Z speaker inputs.

Current LED not illuminated (even at peaks of signal)

Loop not connected or open circuit - See above for correct loop location, and check loop continuity using a resistance meter. Value should be under 300mW.

Relevant IN control not turned up far enough - adjust control as appropriate

No field received in the loop area

If Current LED is illuminated at peaks of signal, but no field is received in the loop area, then the loop is installed in the wrong place or there is a short circuit between the ends of the feed cable. Read the 'Loop design' section above to confirm loop design.

If Current LED is not illuminated, see previous troubleshooting options for a solution.

TECHNICAL SPECIFICATIONS

INPUTS

Power Supply

Supply Voltage Range: 90V-264V (mains)

Connector: Fused screw terminal

Power Consumption: 230V AC into rated load, 1.5mm² solid core or untinned stranded wire.

Fuse: T 1A L (120V)

Fuse: T 630mA L (230V)

Power Consumption (230V): 12W (110mA)

continuous pink noise, 25W (190mA)

continuous sine, 3.25W (<60mA) quiescent

Indication: LED on PCB

Inrush: <±25A_{pk}

Inputs 1 & 2

Connector: Wago 264 Cage Clamp for 0.78

- 2.5mm² solid core or untinned fine stranded wire

Line level

Rated source Impedance: 1.8 k Ω
differential

Input Isolation: 1500 V

Rated source EMF: (Sensitivity) -16dBu for
full output

Overload: >+22dBu

SnR: >90dB

Adjustment: Level control, per channel

OUTPUTS

Loop Output

Connector: Wago 264 Cage Clamp for 0.78

- 2.5mm² solid core or untinned fine
stranded wire

Compliance Voltage: 1.1V_{rms} (1.6V_{pk})

Max output current: 11A_{rms}

Rated time for delivery: 1min

Rated temperature limited output current

(pink): 6A_{rms}

Rated THD: <1%

Output Impedance: >1 Ω

Current Adjustment: Full Range

Current Indication: LED indicates >3A_{rms}

Loop Impedance

0.1 Ω to 0.2 Ω , 0.14 Ω reactive at 1.6kHz

Rated load: 9uH, 0.1R

AUDIO SYSTEM

Freq Response:

100Hz to 5kHz \pm 1.5dB relative to 1kHz at low level, measured as loop current with no metal loss correction

Compression:

Time constants optimised for speech

AGC:

Dynamic Range: >36dB

Control: By adjusting input level/gain

Indication: LED on PCB

MLC (Metal Loss Correction):

0 dB to 3dB / Octave boost.

Correction: Adjustable

PHYSICAL

Dimensions:

Weight: 3kg

Length: 366mm

Width: 158mm

Height: 49mm

Standards:

Meets relevant CE, EMC and safety standards.

IEC 60118-4 AFILS

Environment:

IP22 <90% relative humidity, -20 to +50°C
(battery float life derates by 4% per °C above 25°C)

Please contact Ampetronic if you need further assistance.

WARRANTY

This product carries a five year parts and labour warranty from date of shipment from Ampetronic. To qualify for the five year warranty, the product must be registered at www.ampetronic.co (products/warranty), without which the warranty will be valid for two years only.

The warranty could be invalidated if the instructions in this handbook are not followed correctly, or if the unit is misused in any way.

Note: Battery is only covered by a 1 year warranty.

DECLARATION OF CONFORMITY

Manufacturer: Ampetronic Ltd
Unit 2, Trentside Business Village
Farndon Road
Newark
NG24 4XB

Declares that the product:

Description: Hearing Loop Driver
Type name: HLS-2B

Conforms to the following Directive(s) and Norm(s):

Directive 2004/108/EC

EMC: EN55103-1 : 2009+A1:2012 Emission
EN55103-2 : 2009 Immunity

Directive 2006/95/EC

Safety: EN60065 : 2014

Directive 2011/65/EU RoHS

Date: January 2016

J.R. Pieters
Managing Director

Ampetronic Ltd

Tel: +44 (0) 1636 610062 Fax: +44 (0) 1636 610063

www.ampetronic.co

Email: sales@ampetronic.co